

MODEL **HW-7 Low-Power
CW Transceiver**

HEATHKIT[®]
ASSEMBLY MANUAL

Model HW-7 Low-Power CW Transceiver

HEATH COMPANY • BENTON HARBOR, MICHIGAN



Copyright © 1972
Heath Company
All rights reserved

PRICE \$2.00

595-1455-02

Assembly
and
Operation
of the



**LOW-POWER
CW TRANSCEIVER
MODEL HW-7**



TABLE OF CONTENTS

Introduction	2
Parts List	2
Step-by-Step Assembly	
Circuit Boards	5
Circuit Board Wiring	14
Circuit Board Checkout	16
Chassis Assembly and Wiring	16
Front Panel Mounting	22
Initial Tests	26
Alignment	27
Final Assembly	29
Operation	29
In Case of Difficulty	30
Troubleshooting Chart	31
Specifications	32
Circuit Description	34
Chassis Photograph	36
Circuit Board X-Ray Views	37
Circuit Board Voltage Charts	38
Basing Diagrams	39
Schematic. . . (fold-out from page)	39
Warranty	Inside front cover
Customer Service	Inside rear cover

HEATH COMPANY
BENTON HARBOR, MICHIGAN 49022

INTRODUCTION

The Model HW-7 Heathkit Transceiver is a three-band QRP (low power) CW Transceiver with both built-in VFO and crystal transmit provisions. Band coverage is the CW portion of forty, twenty, and fifteen meters. The Transceiver can be operated from the Heathkit Accessory Power Supply Model HWA-7-1, an equivalent low impedance power supply, or batteries. The experienced amateur, QRP man, and novice alike will appreciate the dependability and versatility of this Transceiver.

Whether you use it for standby, camping, emergency operation, or your primary rig, the Transceiver will prove its

worth. Band changing and tune-up are easily accomplished with pushbutton band selection and single-control Tuning. The light-weight and compact Transceiver has pushbutton crystal transmit provisions for the novice or QRP roundtables. Main tuning is accomplished through a 6-to-1 vernier that is virtually backlash free. A Relative Power meter, built-in sidetone, and carry-along size make the Transceiver a pleasure to operate.

Refer to the "Kit Builders Guide" for complete information on unpacking, parts identification, tools, wiring, soldering, and step-by-step assembly procedures.

PARTS LIST

Check each part against the following list. The key numbers correspond to the numbers in the Parts Pictorial (fold-out from Page 5).

NOTE: Any part that is packaged in an individual envelope with its part number on it should be placed back in the

envelope after it is identified until it is called for in a step.

To order a replacement part, refer to the Price Each column and use the Parts Order Form furnished with this kit. If a Parts Order Form is not available, refer to "Replacement Parts" inside the rear cover of the Manual.

KEY PART No.	PARTS No.	DESCRIPTION	PRICE Each
--------------	-----------	-------------	------------

RESISTORS

NOTE: All resistors are 1/2-watt, $\pm 10\%$ tolerance.

A1	1-140	2 ✓	1.5 Ω (brown-green-gold)	.10
A1	1-41	1 ✓	10 Ω (brown-black-black)	.10
A1	1-103	1 ✓	33 Ω (orange-orange-black)	.10
A1	1-3	6 ✓	100 Ω (brown-black-brown)	.10
A1	1-6	3 ✓	470 Ω (yellow-violet-brown)	.10
A1	1-9	9 ✓	1000 Ω (brown-black-red)	.10
A1	1-11	1 ✓	1500 Ω (brown-green-red)	.10
A1	1-16	4 ✓	4700 Ω (yellow-violet-red)	.10
A1	1-20	2 ✓	10 k Ω (brown-black-orange)	.10
A1	1-21	- 1 ✓	15 k Ω (brown-green-orange)	.10
A1	1-22	- 1 ✓	22 k Ω (red-red-orange)	.10
A1	1-25	5 ✓	47 k Ω (yellow-violet-orange)	.10
A1	1-47	- 1 ✓	56 k Ω (green-blue-orange)	.10
A1	1-26	- 1 ✓	100 k Ω (brown-black-yellow)	.10
A1	1-126	- 1 ✓	180 k Ω (brown-gray-yellow)	.10

KEY PART No.	PARTS No.	DESCRIPTION	PRICE Each
--------------	-----------	-------------	------------

2-WATT RESISTORS-CONTROLS

A2	1-20-2	2 ✓	100 Ω (brown-black-brown) resistor	.10 ✓
A3	10-222	1 ✓	50 k Ω LIN (linear taper) control	.45 ✓
A4	19-95	1 ✓	10 k Ω AUD (audio taper) control with switch	1.05 ✓

CAPACITORS

Mica

B1	20-77	2 ✓	24 pF	.15
B1	20-96	1 ✓	36 pF	.15
B1	20-101	2 ✓	47 pF	.15
B1	20-102	2 ✓	100 pF	.15
B1	20-103	1 ✓	150 pF	.15
B1	20-105	3 ✓	180 pF	.20

Ceramic

B2	21-155	1 ✓	33 pF	.10
B2	21-47	5 ✓	.01 μ F	.10
B2	21-143	8 ✓	.05 μ F	.20

KEY PART No.	PARTS No.	PER KIT	DESCRIPTION	PRICE Each
Polystyrene				
B3	29-20	2 ✓	1000 pF	.30
B3	29-21	1 ✓	1200 pF	.30
B4	27-62	1 ✓	.68 μ F	.60
Electrolytic				
B5	25-123	4 ✓	2 μ F	.40
B6	25-145	1 ✓	25 μ F	.50
B7	25-117	3 ✓	100 μ F	.50
B8	25-230	1 ✓	2000 μ F	1.90
Variable				
B9	26-139	2 ✓	1-section	3.45
B10	26-140	1 ✓	2-section	4.65
B11	31-52	3 ✓	8-60 pF mica trimmer	.40
Other				
B12	28-4	1 ✓	1.5 pF phenolic (brown-green-white)	.10
B13	27-47	✓8	.1 μ F Mylar*	.20
B13	27-86	✓1	.47 μ F Mylar	.40
B13	27-85	✓1	.22 μ F Mylar	.20
COILS-CHOKES				
C1	40-1608	1 ✓	Driver coil	.90
C1	40-1624	1 ✓	Receiver antenna coil	.70
C2	40-1609	2 ✓	40 meter output coil	.55
C2	40-1610	2 ✓	20 meter output coil	.55
C2	40-1611	2 ✓	15 meter output coil	.55
C3	40-1612	1 ✓	VFO (variable frequency oscillator) coil	.65
C4	40-1619	1 ✓	Audio filter coil	.85
C5	40-1620	1 ✓	40 meter doubler coil	.45
C5	40-1621	1 ✓	20 meter doubler coil	.45
C5	40-1622	1 ✓	15 meter tripler coil	.45
C6	45-62	1 ✓	26 μ H RF choke	.40
C7	45-82	1 ✓	350 μ H RF choke	.40

TRANSISTORS-DIODES-INTEGRATED CIRCUIT

NOTE: Transistors are marked for identification in one of the following four ways:

1. Part number.
2. Transistor type number.
3. Part number and transistor type number.
4. Part number with a transistor type number other than the one listed.

*DuPont Registered Trademark

KEY PART No.	PARTS No.	PER KIT	DESCRIPTION	PRICE Each
TRANSISTORS-DIODES-INTEGRATED CIRCUIT				
Do not remove the shorting spring from around the leads of the 40673 transistor (D-2). Leave it in place until you are instructed to remove it.				
D1	417-116	1 ✓	S2091 transistor	.60
D2	417-274	1 ✓	40673 transistor <i>4 prong</i>	2.25
D3	417-224	2 ✓	MPSU05 transistor	1.10
D4	417-169	2 ✓	MPF105 transistor	1.50
D4	417-172	2 ✓	MPS6521 transistor	1.80
D5	417-118	2 ✓	2N3393 transistor	.40
D5	417-201	2 ✓	X29A829 transistor	.50
D6	442-4	1 ✓	CA3035V1 integrated circuit	3.90
D7	56-26	2 ✓	1N191 diode	.25
D7	56-55	1 ✓	VR-36A zener diode	1.00

HARDWARE
#6 Hardware

E1	250-33	3 ✓	6-32 x 1/8" setscrew	.05
E2	250-138	9 ✓	6-32 x 3/16" screw	.05
E3	250-56	6 ✓	6-32 x 1/4" screw	.05
E4	250-416	4 ✓	6-32 x 1/4" flat head screw	.05
E5	250-127	5 ✓ 4 ✓	6-32 x 1/2" self-tapping screw	.05
E6	250-250	1 ✓	6-32 x 1/2" black screw	.05
E7	250-170	11 ✓	#6 x 1/4" sheet metal screw	.05
E8	253-27	1 ✓	#6 flat washer	.05
E9	254-1	12 ✓ 11 ✓	#6 lockwasher	.05
E10	252-3	12 ✓	6-32 nut	.05

Control Hardware

F1	253-10	4 ✓	Control flat washer	.05
F2	253-16	2 ✓	Control fiber shoulder washer	.05
F3	254-5	1 ✓	Control lockwasher	.05
F4	252-7	4 ✓	Control nut	.05

Miscellaneous Hardware

G1	250-175	2 ✓	2-56 x 3/8" screw	.05
G2	250-52	2 ✓	4-40 x 1/4" screw	.05
G3	250-34	1 ✓	4-40 x 1/2" screw	.05
G4	250-322	2 ✓	4-40 x 5/8" flat head screw	.05
G5	254-9	5 ✓	#4 lockwasher	.05
G6	252-51	2 ✓	2-56 nut	.05
G7	252-15	5 ✓	4-40 nut	.05
G8	255-2	3 ✓ 2 ✓	3/16" spacer	.05
G9	250-1193	1 ✓	8-32 x 3/8" setscrew	.05



KEY PART No.	PARTS No.	DESCRIPTION	PRICE Each	KEY PART No.	PARTS No.	DESCRIPTION	PRICE Each
WIRE-CABLE				MISCELLANEOUS			
	344-55	1 ✓ Green wire	.05/ft	L1	75-61	4 ✓ Cabinet nut	.10
	344-2	1 ✓ Black stranded wire	.05/ft	L2	261-34	4 ✓ Foot	.10
	344-3	1 ✓ Red stranded wire	.05/ft	L3	100-1608	1 ✓ Vernier	1.70
	343-15	1 Coaxial cable	.10/ft	L4	352-13	1 ✓ Silicone grease	.15 ✓
ELECTRICAL PARTS				L5	446-602-1	1 ✓ Dial window	.50
H1	64-603	1 ✓ Switch assembly	4.30	L6	464-65-1	1 ✓ Dial	.65
H2	69-47	1 ✓ Relay	2.65	L7	490-1	1 ✓ Alignment tool	.10
H3	407-135	1 ✓ Meter	4.65	L8	490-5	1 ✓ Nut starter	.10
H4	434-38	1 ✓ Crystal socket	.20		462-257	1 ✓ Large knob	.55
H5	434-107	1 ✓ Antenna socket	.40		462-258	3 ✓ Small knob	.35
H6	438-4	2 ✓ Antenna plug	.10		85-1356-2	1 ✓ Circuit board	4.85
H7	436-20	2 ✓ Phone jack	.45		391-34	1 ✓ Blue and white label	
PINS-CONNECTORS					597-260	1 ✓ Parts Order Form	
J1	432-72	2 Male pin	.10		597-308	1 ✓ Kit Builders Guide	
J2	432-73	2 Female pin	.10			1 ✓ Manual (See front cover for part number.)	2.00
J3	432-94	1 ✓ Chassis connector	.30			Solder (Additional 3' ✓ rolls of solder, #331-6, can be ordered for 15 cents each.)	
J4	432-95	1 ✓ Cable connector	.25				
SHEET METAL PARTS				The above prices apply only on purchases from the Heath Company where shipment is to a U.S.A. destination. Add 10% (minimum 25 cents) to the price when ordering from a Heathkit Electronic Center to cover local sales tax, postage, and handling. Outside the U.S.A. parts and service are available from your local Heathkit source and will reflect additional transportation, taxes, duties, and rates of exchange.			
K1	200-683	1 ✓ Chassis	2.90				
K2	203-1429-1	1 ✓ Front panel	2.45				
K3	203-1430-1	1 ✓ Rear panel	2.35				
K4	204-1844	1 ✓ Rail	.65				
K5	204-1845	1 ✓ VFO (variable frequency oscillator) bracket	.45				
K6	205-1436	2 ✓ Heat sink	.30				
K7	90-566-1	2 ✓ Cabinet shell	3.50				

INITIAL TESTS

Refer to Figure 1-1 (fold-out from Page 24) for the following steps.

- () Rotate all the controls fully counterclockwise.
- () Press in the 40M pushbutton.
- () Be sure the CRYSTAL TRANSMIT pushbutton is in its out position.
- () Connect the 50 Ω dummy load to the ANTENNA phono socket on the rear panel.
- () Connect a pair of headphones, preferably 2000 Ω , to the HEADPHONES jack on the rear panel.

NOTE: The Heathkit Electronic Keyer, Model HD-10, can be used with this Transceiver. Otherwise be sure that your keyer or key has a phone plug that mates with the KEY jack on the Transceiver.

- () Connect your key to the Transceiver KEY jack.
- () Connect an appropriate power supply, such as the Heathkit Model HWA-7-1, to the POWER connector on the rear panel. CAUTION: Be sure to observe the correct polarity or the transistors will be permanently damaged.

NOTE: If you do not get the required results in the following steps, turn OFF the Transceiver and refer to the "In Case of Difficulty" section on Page 30.

- () Turn on the power supply and then turn on the Transceiver. Rotate the AF GAIN control to the 12 o'clock position. You should hear noise in the headphones.

- () Tighten the three driver trimmer capacitors until they are just snug.
- () Loosen the 15M DRIVER capacitor 3/4 turn from its snug position.
- () Loosen the 20M DRIVER capacitor 1/8 turn from its snug position.
- () Loosen the 40M DRIVER capacitor 1/4 turn from its snug position.
- () Key the Transceiver. The relay should energize and a sidetone should be heard in the headphones. Release the key.
- () Key the Transceiver. Rotate the TUNING knob for a peak indication on the relative power meter. Release the key.

NOTE: It is possible to obtain two peak indications on both the 20M band and the 15M band. Tune only for the peaks called for below and disregard the others.

- () Press in the 20M pushbutton.
- () Key the Transceiver. Rotate the TUNING knob for a peak indication (between 1 and 2 on the tuning dial) on the relative power meter and then release the key.
- () Press in the 15M pushbutton.
- () Key the Transceiver. Rotate the TUNING knob for a peak indication (between 2 and 3 on the tuning dial) on the relative power meter and then release the key.

This completes the "Initial Tests." Proceed to the "Alignment" section of the Manual.

ALIGNMENT

NOTE: Transceiver alignment requires the use of a calibrated receiver, such as a Heathkit Model SB-303 or equivalent, capable of receiving 7.0 MHz, 7.2 MHz, 14.0 MHz, and 14.2 MHz.

VFO ALIGNMENT

- () Turn on the calibrated receiver and allow it to warm up.
- () Be sure the 50 Ω dummy load, headphones, key, and power supply are connected to the Transceiver.
- () Press in the 40M pushbutton.
- () The CRYSTAL TRANSMIT pushbutton should be in its out position.
- () Rotate the TUNING knob fully counterclockwise.
- () Rotate the RECEIVER PRESELECTOR knob fully counterclockwise.
- () Rotate the AF GAIN – OFF control to the twelve o'clock position.
- () Set the Transceiver VFO to 7.1 MHz.

NOTE: In the following steps, you will zero beat the receiver to its crystal calibrator. Then you will zero beat the calibrated receiver against the Transceiver. Zero beat is a point where the two frequencies being combined (beat against each other) are exactly the same frequency. As zero beat is approached, the tone caused by the two combined frequencies will gradually decrease in pitch and volume until it just stops.

The two frequencies to be zero beat first are the crystal calibrator and receiver frequencies. Then the receiver frequency will be used to zero beat the Transceiver frequency. The end result will be a calibrated Transceiver that has a true frequency nearly identical to the dial frequency.

- () Tune the calibrated receiver to 7.0 MHz. Then turn on the crystal calibrator and gradually adjust the receiver frequency until the tone decreases in pitch and volume. It may be necessary to increase the RF and AF gain controls. When the tone just stops, zero beat has been reached.
- () Turn off the crystal calibrator.
- () Tune the Transceiver VFO to 7.0 MHz.
- () Refer to Figure 1-1 (fold-out from Page 24) and tighten both trimmers on the VFO capacitor until they are just snug. Then rotate each trimmer 1/2-turn counterclockwise.
- () Again refer to Figure 1-1 and rotate the top slug in the VFO coil until a zero beat is heard from the calibrated receiver. It may be necessary to turn down the calibrated receiver AF gain control. Use the supplied alignment tool to make the adjustment. Do not rotate the coil slug more than one turn in either direction.
- () Tune the calibrated receiver to 7.2 MHz.
- () Tune the Transceiver to 7.2 MHz.
- () If a zero beat is not heard, rotate the rear trimmer on the VFO capacitor slightly in either direction until a zero beat is reached.
- () Again tune the calibrated receiver and the Transceiver to 7.0 MHz and check the zero beat. Then recheck the 7.2 MHz position for a zero beat. When no further improvement can be made in the zero beats, proceed to the next step.
- () Tune and zero beat the calibrated receiver to 14.0 MHz.
- () Press in the 20M pushbutton on the Transceiver.
- () Tune the Transceiver main tuning to 14.0 MHz.



- () Again refer to Figure 1-1 and use the alignment tool to adjust the bottom slug of the VFO coil until a zero beat is heard from the calibrated receiver. This adjustment is rather difficult to accomplish since the zero beat point can be passed over very easily. Carefully rotate the coil slug back-and-forth until the zero beat is reached.
- () Tune the calibrated receiver to 14.2 MHz.
- () Tune the Transceiver to 14.2 MHz.
- () If a zero beat is not heard, rotate the front trimmer on the VFO capacitor slightly in either direction until a zero beat is reached.
- () Again tune the calibrated receiver and the Transceiver to 14.0 MHz and check the zero beat. Then recheck the 14.2 MHz position for a zero beat. When no further improvements can be made in the zero beats, proceed to the next step.
- () The calibrated receiver is no longer needed; set it aside.
- () Set the main tuning to 14.1 MHz.
- () Key the Transceiver and rotate the TUNING knob for a peak meter indication between 1 and 2 on the tuning dial. Release the key.
- () Key the Transceiver and adjust the 20M DRIVER capacitor for a peak meter indication. Release the key.
- () Key the Transceiver and adjust the 20M DOUBLER coil for a peak meter indication. Release the key.
- () Press in the 15M pushbutton.
- () Set the main tuning to 21.15 MHz.
- () Key the Transceiver and rotate the TUNING knob for a peak meter indication between 2 and 3 on the tuning dial. Release the key.
- () Key the Transceiver and adjust the 15M DRIVER capacitor for a peak meter indication. Release the key.
- () Key the Transceiver and adjust the 15M TRIPLER coil for a peak meter indication. Release the key.

TRANSMITTER ALIGNMENT

- () Press in the 40M pushbutton on the Transceiver.
- () Tune the main tuning to 7.1 MHz.
- () Key the Transceiver. Rotate the TUNING knob for a peak indication on the relative power meter and release the key.
- () Key the Transceiver and adjust the 40M DRIVER capacitor for a peak meter indication. Release the key.
- () Key the Transceiver and adjust the 40M DOUBLER coil for a peak meter indication. Release the key.
- () Press in the 20M pushbutton.

NOTE: This completes the alignment of the Transceiver for VFO operation. If the Transceiver will be used for crystal operation, install your particular crystal and press in the CRYSTAL TRANSMIT pushbutton. Then adjust the DRIVER capacitor for a peak meter indication on the band you have the Transceiver tuned to.

- () Key the Transceiver and adjust the DELAY control for the desired amount of "delay" that the transmitter "holds in" after the last transmitted character.
- () Do not attempt to adjust the audio filter coil as it was adjusted at the factory.

This completes the "Alignment" of the Transceiver. Proceed to the "Final Assembly" section of the Manual.

FINAL ASSEMBLY

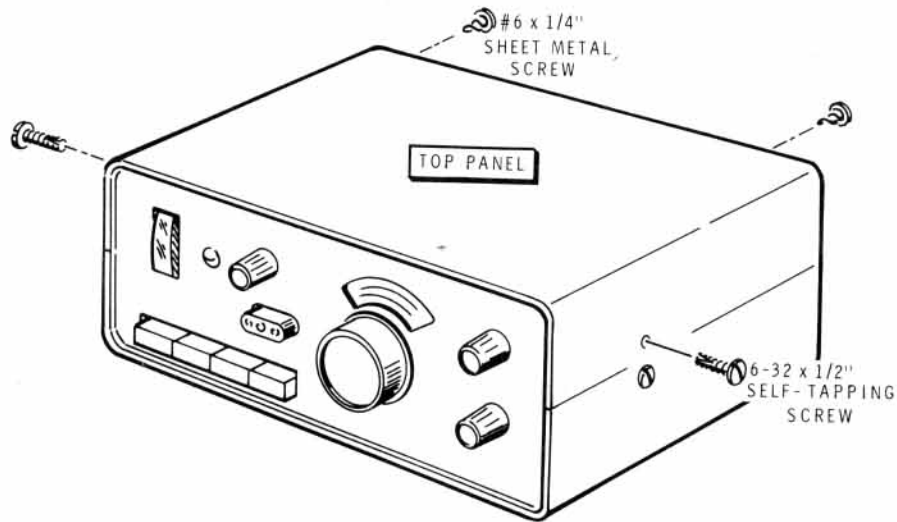

Refer to Pictorial 2-9 for the following steps.

- () Position the remaining cabinet shell on the Transceiver as shown.
- () Mount the cabinet shell to the Transceiver with two #6 x 1/4" sheet metal screws and two 6-32 x 1/2" self-tapping screws.

PICTORIAL 2-9

This completes the assembly of the Transceiver. Proceed to the "Operation" section of the Manual.

OPERATION

The Transceiver is basically a QRP (low power) rig with provisions for crystal control on transmit. As a result, a little patience and experience will greatly improve the operating results. Be sure to read the entire "Operation" section before you use the Transceiver on the air.

TRANSCIVE OPERATION

The CRYSTAL TRANSMIT pushbutton should be in its out position and no crystal should be installed. This is to prevent

excitation of the crystal when it is not actually in the circuit. The following steps indicate the procedure for tuning up and placing the Transceiver on the air.

1. Be sure the 50 Ω dummy load or acceptable antenna, headphones, key, and power supply are connected to the Transceiver.
2. Turn the AF GAIN – OFF control to the 12 o'clock position. Then adjust the control for a comfortable listening level.

3. Press in the pushbutton for the band you intend to operate on.
4. Adjust the main tuning to the portion of the band where you intend to operate.
5. Listen to the headphones and adjust the RECEIVER PRESELECTOR for maximum signal loudness. Be sure it is in the same band segment as the band you are operating on.
6. Key the Transceiver and rotate the TUNING knob for a peak meter indication. Then release the key.
7. The Transceiver is now ready for on-the-air operation. If you used the dummy load for tune-up, it may be necessary to repeak the TUNING knob after your antenna is connected. This is to assure a good electrical match between the antenna and the transmitter.

NOTE: When tuning across the band, always go to the high end of the band first. Then tune down to the low end of the band. This is to assure that you will be on the high side of the zero beat when listening to a signal. Otherwise you may answer a CQ on the low side of zero beat and your transmitting frequency will be approximately 5 kHz low.

CRYSTAL OPERATION

The same procedures apply for crystal operation as for transceive, with one exception. After you install your crystal, be sure the CRYSTAL TRANSMIT pushbutton is pressed in. The required crystal specifications are covered in the "Specifications" section of the Manual.

ANTENNAS

The Transceiver should be used with 50 ohm to 75 ohm antennas having a low VSWR. Lightweight hookup wire dipoles and inverted vee's are sufficient for solid contacts. They can be quickly strung up for camping trips and

emergency operation, as well as field day. However, antennas of the beam and quad type will provide a significant improvement in performance, much more so than for medium to high-power rigs.

The "ARRL Antenna Book" is commonly available and includes comprehensive reference work on transmission lines and antennas. Other similar handbooks for the amateur are offered for sale and can often be found in a public library.

OPERATING HINTS

When operating a QRP (low power) rig, your transmitted signal may be below the signal level preferred by most operators. Generally, lower power signals lose out unless a few simple techniques are followed. In many cases, listening for a CQ is more acceptable since your signal then has a greater chance of being copied. A station can be called just after he completes a contact which may also prove successful. Also, be sure that you are on the high side of zero beat when you transmit as described previously.

You may find the Transceiver is susceptible to some microphonics. This is due to the nature of the circuit and should not be a problem in normal operation. Foreign phone and broadcast stations may also be heard when tuning the receiver preselector. The detector stage can become overloaded if the receiver preselector is not peaked properly in the correct band segment. You can use an antenna tuner with the Transceiver to improve the transmitter-to-antenna impedance match and the receiver's selectivity.

Emergency operation is sometimes a necessity and always unexpected. The Transceiver is well suited for these situations if an antenna is available. A power source is usually no problem since any automobile battery or lantern batteries of the appropriate voltage can provide hours of dependable operation. Refer to the "Specifications" section for voltage and current requirements.

IN CASE OF DIFFICULTY

This section of the Manual is divided into two parts: "Visual Checks," and the "Troubleshooting Chart." Begin your search by carefully following the checks listed below. After they are completed, refer to the "Troubleshooting Chart" if necessary.

VISUAL CHECKS

NOTE: The following checks will be most effective if you apply them to one circuit board, or other part of the kit, at a time.

1. About 90% of the kits that are returned for repair do not function properly due to poor connections and soldering. Therefore, many troubles can be eliminated by a careful inspection of connections to make sure they are soldered as described in the "Soldering" section of the "Kit Builders Guide." Resolder any doubtful connections and be sure all the wires are soldered at places where several wires are connected.
2. Check each circuit board to be sure there are no solder bridges between adjacent connections. Remove any

- solder bridges by holding a clean soldering iron tip between the two points that are bridged until the excess solder flows down the tip of the soldering iron.
3. Be sure each transistor is in the proper location (correct part number and type number). Be sure that each transistor lead is positioned properly and has a good solder connection to the foil.
 4. Check capacitor values carefully. Be sure the proper part is wired into the circuit at each capacitor location. Always check the polarity of electrolytic capacitors to be sure they are installed correctly.
 5. Check each resistor carefully. It would be easy, for example, to install a 1000 Ω (brown- black-red) resistor where a 100 k Ω (brown-black-yellow) resistor is called for. A resistor that is discolored, or cracked, or shows any sign of bulging would indicate that it is faulty and should be replaced.
 6. Be sure the correct diode is installed at each diode location, and that the banded end is positioned correctly.
 7. Recheck the wiring. Trace each lead in colored pencil on the Pictorial as it is checked. It is frequently helpful to have a friend check your work. Someone who is not familiar with the unit may notice something you have consistently overlooked.
 8. Check all component leads connected to the circuit boards. Make sure the leads do not extend through the circuit board and make contact with other connections or parts, such as coil shields or the chassis.
- If the trouble is not located after the "Visual Tests" are completed and a voltmeter is available, check voltage readings against those shown in the Schematic Diagram and "X-Ray Views." A review of the "Circuit Description" may also help you determine the cause of a trouble.
- In an extreme case where you are unable to resolve a difficulty, refer to the "Customer Service" information inside the rear cover of the Manual. Your Warranty is located inside the front cover.

Troubleshooting Chart

CONDITION	POSSIBLE CAUSE
No relative power output indication.	<ol style="list-style-type: none"> 1. Driver trimmer capacitors not peaked. 2. Relay contacts not together. 3. Q6 and/or Q7 installed backwards. 4. Faulty diode D1.
Transmitter does not key.	<ol style="list-style-type: none"> 1. Faulty Q12.
Crystal oscillator inoperative.	<ol style="list-style-type: none"> 1. Driver trimmer capacitors not peaked with crystal when in crystal transmit mode.
Sidetone inoperative.	<ol style="list-style-type: none"> 1. Faulty Q10 and/or Q11.
Relay inoperative.	<ol style="list-style-type: none"> 1. Faulty Q8 and/or Q9.
Receiver section inoperative.	<ol style="list-style-type: none"> 1. Shorting spring not removed from Q1. 2. Faulty Q1.
No audio output.	<ol style="list-style-type: none"> 1. Faulty IC1.

SPECIFICATIONS

TRANSMITTER

DC Power Input	3 watts on 40 meters. 2.5 watts on 20 meters. 2 watts on 15 meters.
Frequency Control	40 meter crystal, or built-in VFO on 40 meters. 20 meter crystal or built-in VFO on 20 meters. 15 meter crystal, or built-in VFO on 15 meters.
Output Impedance	50 Ω unbalanced.
Sidetone	Built-in.
Spurious and Harmonic Levels	At least 25 dB down.

RECEIVER

Sensitivity	Less than 1 microvolt provides a readable signal.
Selectivity	1 kHz at 6 dB down.
Type of Reception	CW.
Audio Output Impedance	1000 Ω nominal.

GENERAL

Frequency Coverage	40 meters, 7.0 to 7.2 MHz. 20 meters, 14.0 to 14.2 MHz. 15 meters, 21.0 to 21.3 MHz.
Frequency Stability	Less than 100 Hz drift after 10 minutes warmup.
Power Required	13 volts DC, 35 mA receive and 450 mA transmit.

Active Devices	Synchrodyne detector, 40673 dual-gate MOSFET. Audio amplifier, CA3035V1 integrated circuit. VFO and buffer, MPF105 JFET. Doubler/tripler, MPS6521 silicon transistor. Driver, MPS6521 silicon transistor. Final Amplifier, two MPSU05 silicon transistors. Sidetone oscillator, 2N3393 silicon transistor and X29A829 silicon transistor. Break-in keying, 2N3393 silicon transistor and X29A829 silicon transistor. Transmitter keying, S2091 silicon transistor.
Dimensions	9-1/4" wide x 8-1/2" deep x 4-1/4" high, including knobs and feet.
Weight	4 lbs. 8 ozs.

The Heath Company reserves the right to discontinue products and to change specifications at any time without incurring any obligation to incorporate new features in products previously sold.

CIRCUIT DESCRIPTION

The Low-Power CW Transceiver, Heathkit Model HW-7, covers the CW portions of the 40, 20, and 15 meter bands. The operating frequency is VFO (variable frequency oscillator) controlled on both transmit and receive, with provision for crystal transmit. Twelve transistors and one integrated circuit comprise the all solid-state circuitry. Requirements for an external power source are discussed in the Specifications section of the Manual.

VFO (VARIABLE FREQUENCY OSCILLATOR)

The heart of the Transceiver is the built-in VFO for both receive and transmit. Oscillator transistor Q2 operates at a frequency determined by coils L12 and L13, and the two section VFO capacitor, C51. In the 40 meter band position, the VFO is actually operating at an 80 meter frequency that is exactly half of the 40 meter dial frequency. Transistor Q3 is a buffer stage which provides isolation for the oscillator to eliminate frequency shifting.

Transistor Q4 acts as a doubler/tripler stage depending upon your band selection. In the 40 meter band, coil L3 and capacitor C29 are resonant at 40 meters which doubles the 80 meter oscillator frequency. Capacitor C57 couples the VFO frequency to the receiver section and capacitor C33 couples the frequency to the transmitter section.

In the 20 meter band, the oscillator (Q2) operates at a 40 meter frequency which is then doubled to 20 meters. In the

15 meter band, the oscillator also operates at a 40 meter frequency which is then tripled to 15 meters.

RECEIVER

The received signal is tuned by coil L1 and receiver preselector capacitor C1. Transistor Q1 is a detector which produces an audio signal from the mixing of the received signal and the VFO signal. The VFO signal is coupled to G2 of transistor Q1 by capacitor C57. Coil L14 and its associated capacitors form an audio selectivity filter with a cutoff frequency of about 1000 Hz.

Audio is coupled to integrated circuit IC1 by capacitor C52 and resistors R41 and R6. IC1 is a linear IC made up of three individual high-gain audio amplifier stages. These amplifiers are cascaded to provide approximately 100 dB of gain which is controlled by AF Gain control R8. The audio output is coupled to Phones jack J2 by capacitor C17.

Sidetone Oscillator

Transistors Q10 and Q11 form the sidetone oscillator circuit which is keyed when the transmitter is keyed. (The keying circuit is discussed in the "Transmitter" section.) The generated sidetone is coupled to audio amplifier IC1 by capacitor C45. The sidetone is coupled to IC1 before the AF Gain control, so its audio level is also controlled.

TRANSMITTER

The transmitter circuitry consists of a crystal oscillator/driver stage, final amplifiers, and a pi-network output circuit for impedance matching and harmonic suppression. Transistor Q5 is the crystal oscillator and/or driver, depending on whether or not the transmitter is VFO or crystal controlled. If VFO control is used, the stage is only a driver which is resonance-tuned by the appropriate driver capacitor, C35 and C36, C37, and C38 with coil L2. When the crystal transmit button is pressed, the stage is a combination Pierce oscillator and driver. The transmitter output frequency is then the same as the external crystal, regardless of the VFO frequency.

Coil L2 couples the driver signal to the final stage that consists of transistors Q6 and Q7 operating in parallel. The RF output signal is switched through the appropriate pi-network which acts as a low-pass filter and provides the necessary impedance matching. Capacitor C42 is the Tuning control which should be adjusted for maximum power output on the relative power meter. Capacitor C43 acts as the loading capacitor across the output to the antenna. Capacitor C44 couples the RF output through relay RL1 to antenna jack J4. The meter circuit couples off a small portion of the RF output, which is then detected by diode D1. Meter M1 indicates the RF output as relative power.

Keying

Transistor Q12 provides a keying function when the key is depressed. This transistor provides the keying for the transmitter driver stage, the sidetone oscillator, the break-in delay switching, and the receiver muting. When the key is depressed, the keying transistor places a B+ voltage on the collector of crystal oscillator/driver transistor Q5 and switches it on. The transmitter is then keyed and provides an

RF output signal. The B+ voltage is simultaneously applied to the sidetone oscillator circuit which couples its tone to audio amplifier IC1.

Depressing the key also places a ground on the emitter of break-in delay transistor Q8 and the input of audio amplifier IC1. The break-in delay circuit switches relay RL1 and connects the antenna to the transmitter. Since the ground is placed at the input to the audio amplifier, and the antenna is switched to the transmitter, no receiver signal is heard. The sidetone is coupled to the second cascaded amplifier of IC1 so the tone can then be heard in the headphones. When the key is released, keying transistor Q12 allows the Transceiver circuitry to return to the normal receive mode.

BREAK-IN DELAY

Transistors Q8 and Q9 provide an adjustable delay circuit for antenna switching. The emitter of break-in delay transistor Q8 is placed at ground when the key is depressed. This pulls the collector to ground which causes relay driver transistor Q9 to energize relay RL1 and switch the antenna from receive to transmit. Relay RL1 will remain energized until the base voltage of relay driver transistor increases to the B+ voltage. When the key is released, the emitter and collector voltages of Q8 try to increase toward B+. Capacitor C19 simultaneously tries to discharge through delay control R8 which determines the break-in delay time. The collector voltage of Q8 will gradually increase until it reaches B+ which causes the base voltage of relay driver transistor Q9 to increase toward B+. This causes relay RL1 to de-energize and switch the antenna from transmit to receive.

BASING DIAGRAMS

COMPONENT	HEATH PART NUMBER	MAY BE REPLACED WITH	BASE DIAGRAM (BOTTOM VIEW)
Q1	417-274	RCA 40673	
Q8, Q11	417-118	G. E. OR T. I. 2N3393	
Q9, Q10	417-201	G. E. OR T. I. X29A829	
Q12	417-116	FAIRCHILD S2091	
Q2, Q3	417-169	MOT. MPF105	
Q4, Q5	417-172	MOT. MPS6521	
Q6, Q7	417-224	MOT. MPSU05	
D1, D2	56-26	1N191	
ZD1	56-55	VR-36A	
IC1	442-4	CA3035V1	

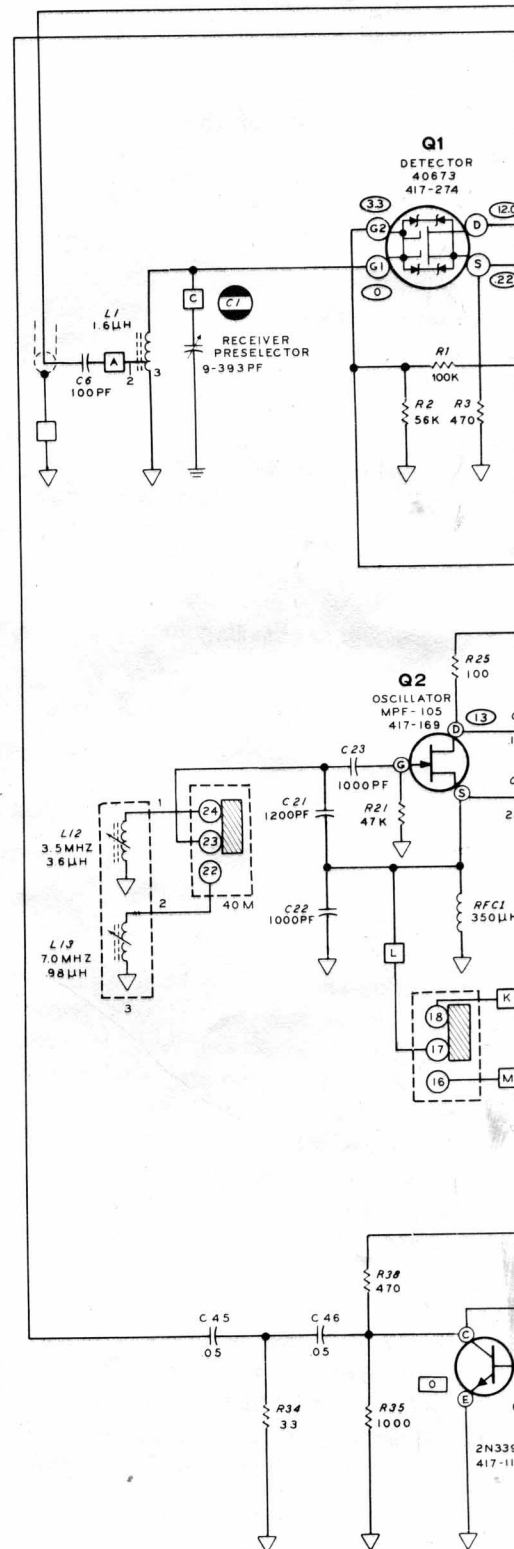

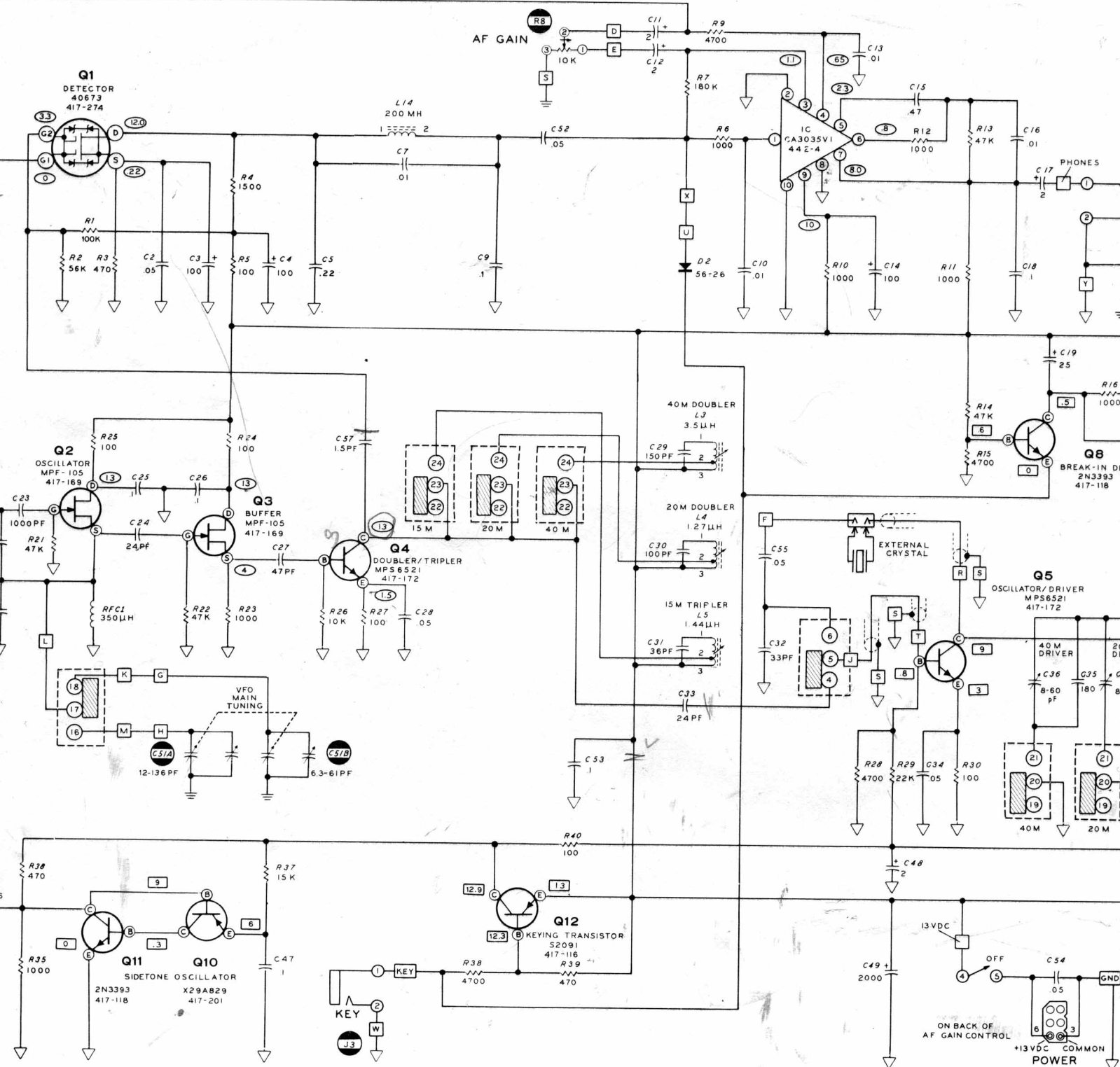

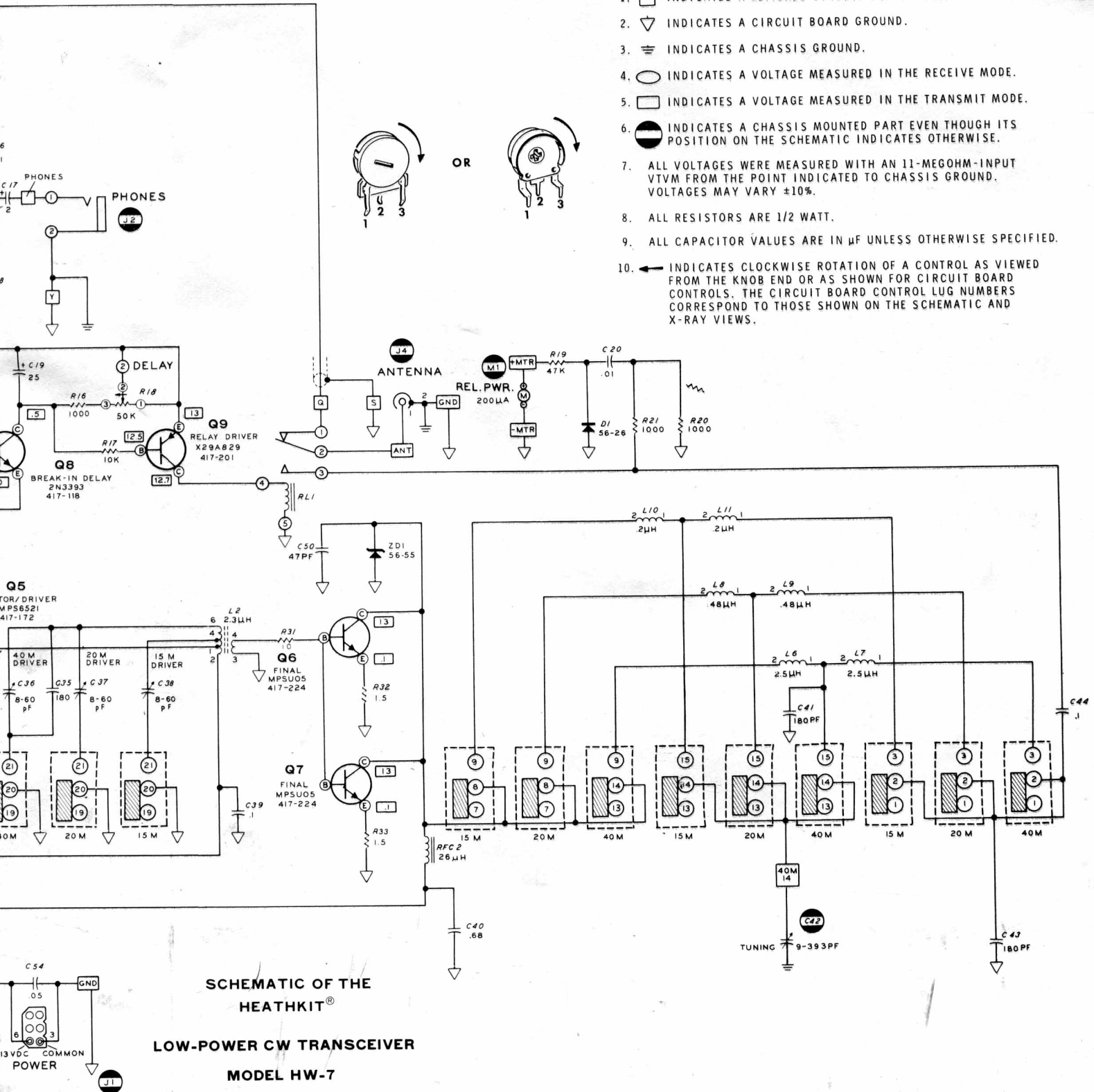

**SCHEMATIC OF THE
HEATHKIT®
LOW-POWER CW TRANSCEIVER
MODEL HW-7**

112872
85 1356

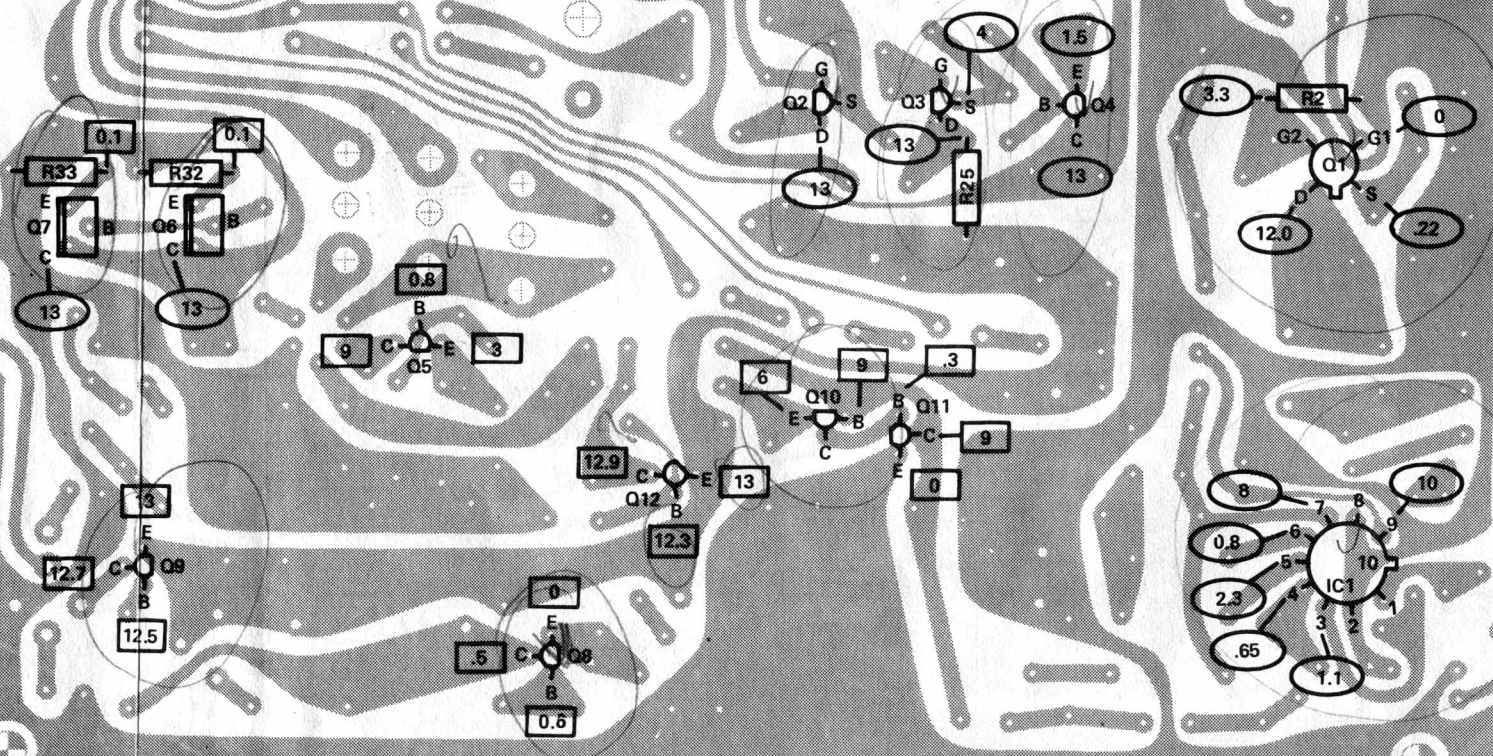

- Transmit
- Receive

112872
85 1356

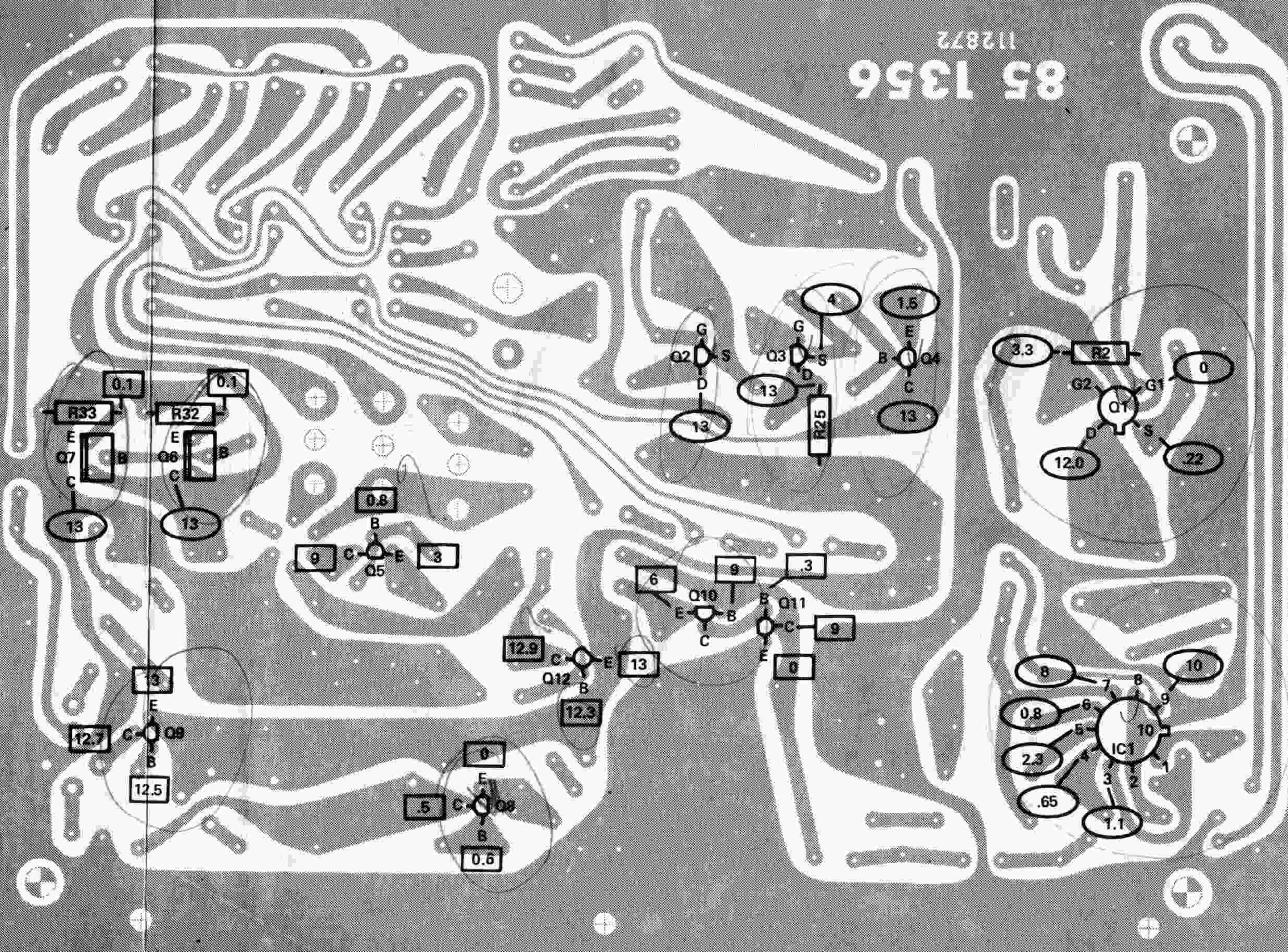

□ Transmit
○ Receive

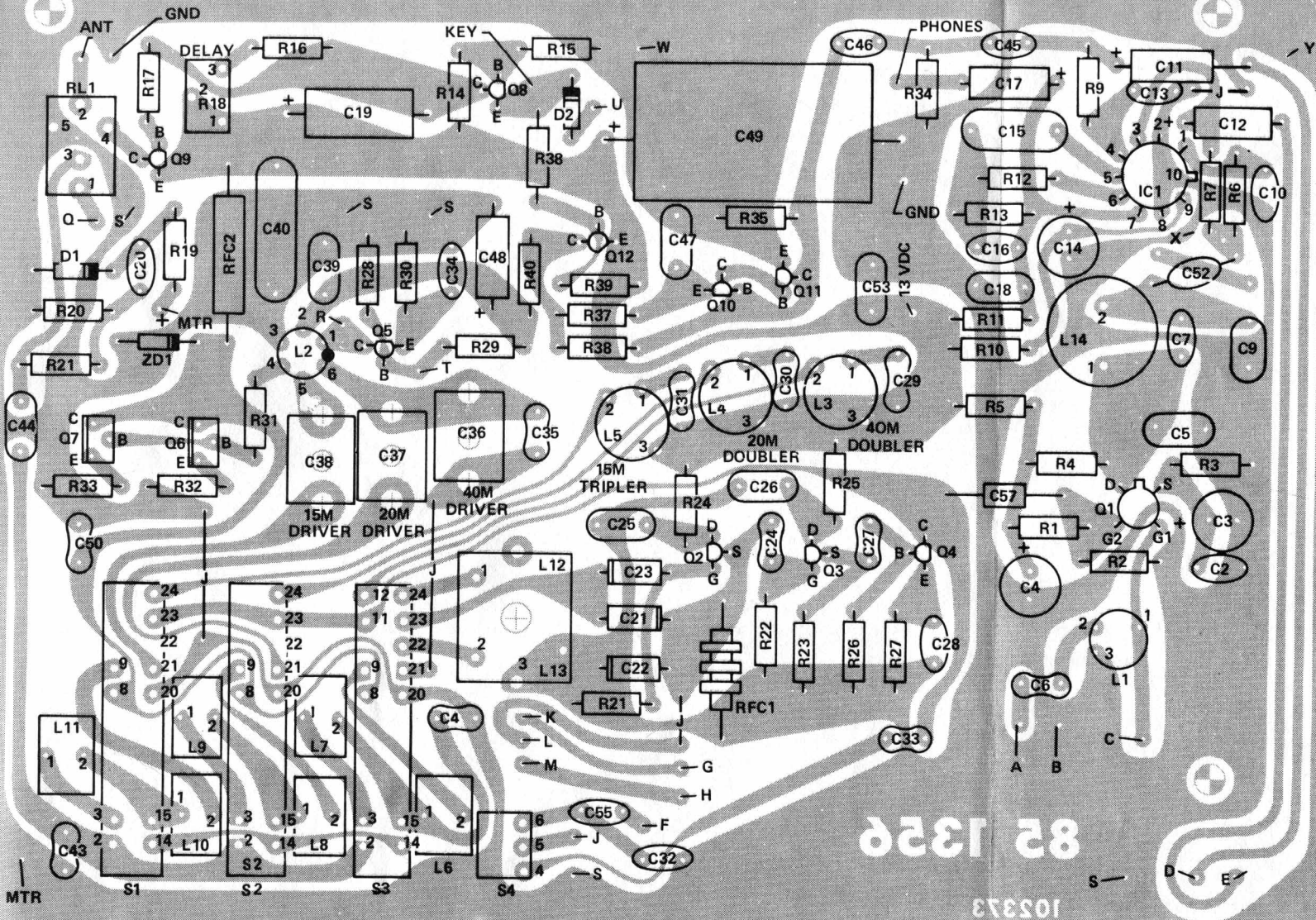

(Viewed from component side)

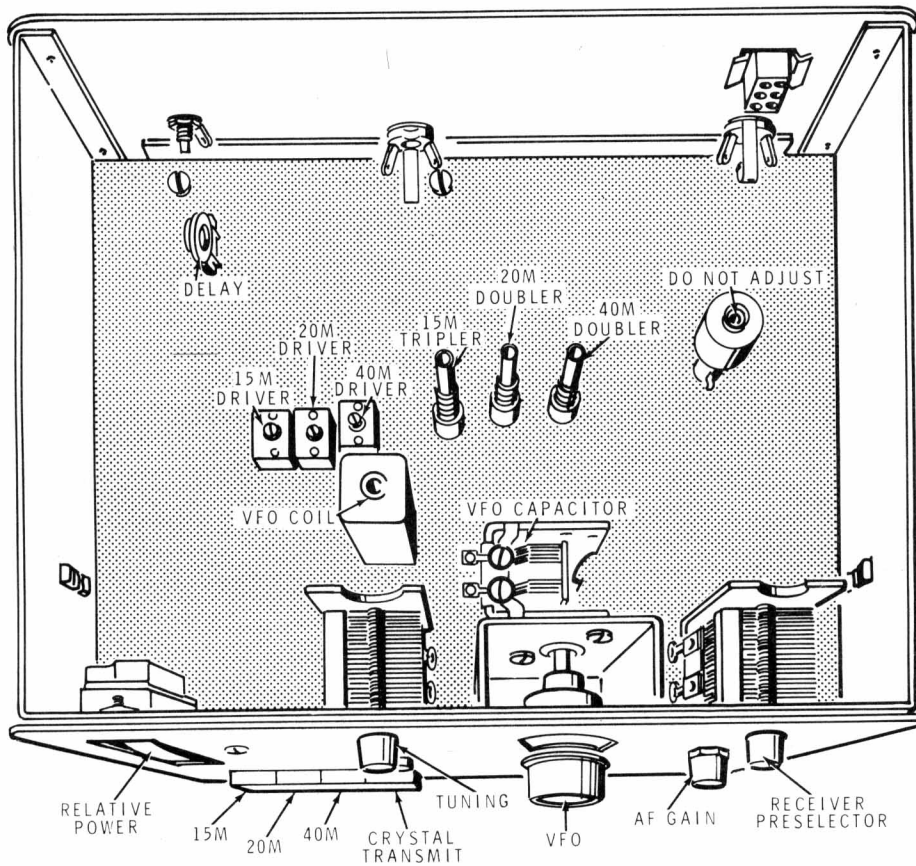

Figure 1-1

NOTE: To identify a part shown in one of these Views, so you can order a replacement, proceed as follows:

1. Note the identification number of the part (R-number, C-number, etc.).

2. Locate the same identification number (next to the part) on the Schematic. The "Description" of the part (for example: 22 k Ω , .05 μ F, or 2N2712) will also appear near the part.

3. Look up this Description in the Parts List.

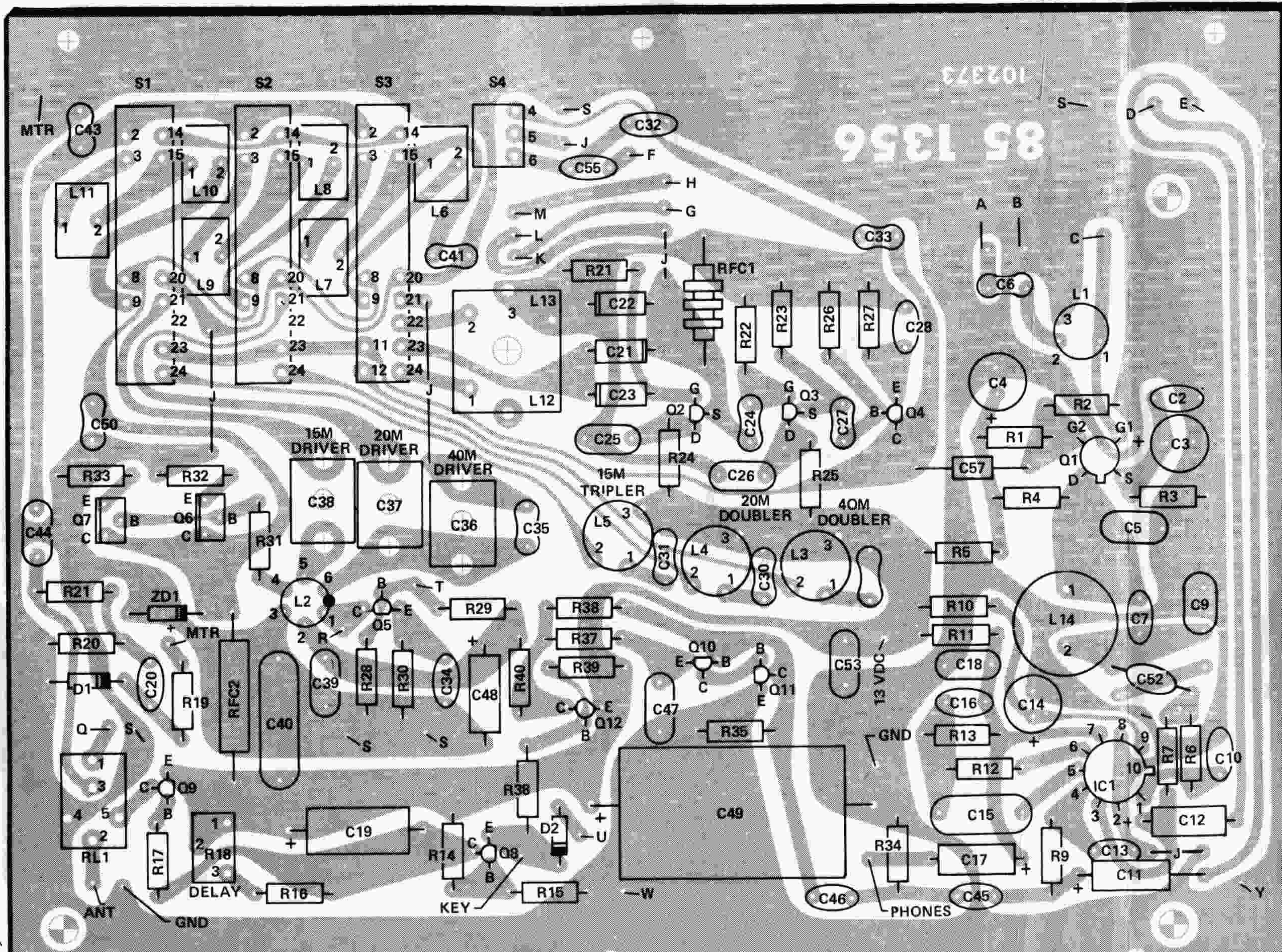

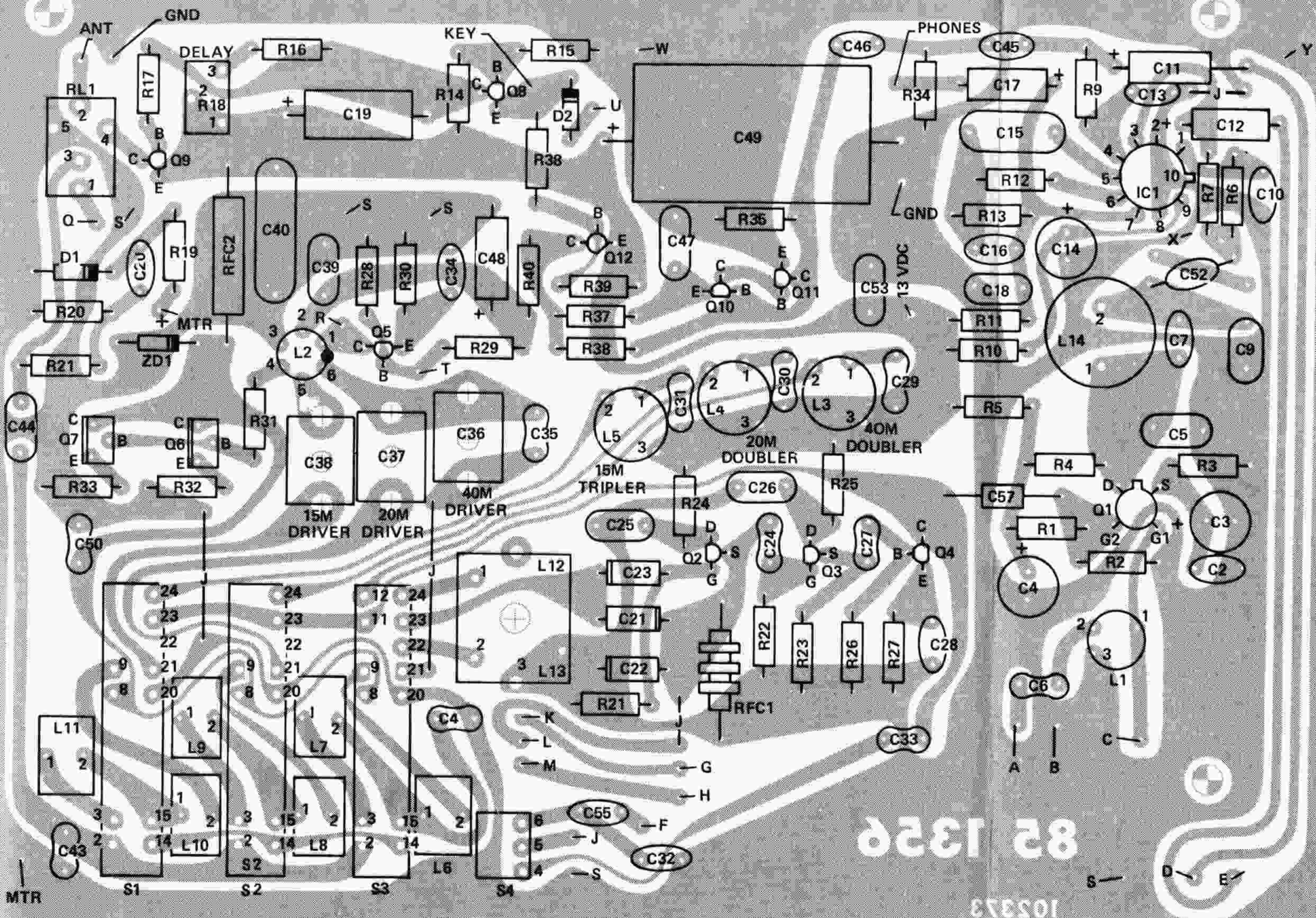

(Viewed from component side)

NOTE: To identify a part shown in one of these Views, so you can order a replacement, proceed as follows:

1. Note the identification number of the part (R-number, C-number, etc.).

2. Locate the same identification number (next to the part) on the Schematic. The "Description" of the part (for example: 22 k Ω , .05 μ F, or 2N2712) will also appear near the part.

3. Look up this Description in the Parts List.

