

SECTION 2 - CREDIT AND SELECTION SYSTEM MAINTENANCE

INTRODUCTION

This section contains price setting procedures, troubleshooting and adjustment instructions and a complete theory of operation of the credit and selection system.

PRICING

The credit and pricing system of the phonograph can be adapted to an almost unlimited variety of pricing combinations. Pricing for each phonograph as set at the factory is indicated by the price card installed in the price window. The following information is provided to facilitate price setting.

SETTING PRICES

Setting prices is accomplished by simply setting 2 banks of 9 switches each in either "ON" or "OFF" positions. A bonus relay is not required for any pricing. Although not compatible with the Model MAF Money Meter, the Credit Computer can be used with Models MBA & MBB Digital Print-Out Money Meters.

The Credit Computer will register nickels and dimes. The nickel diverter in the coin mechanism should be in blocked position as shown.

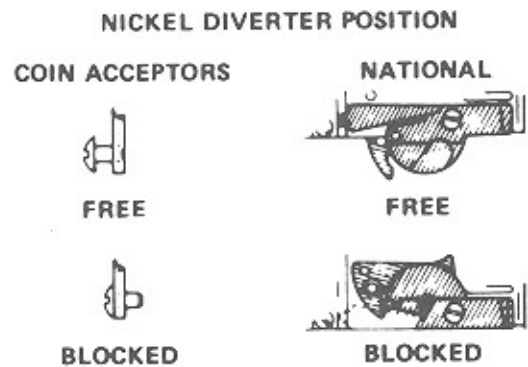
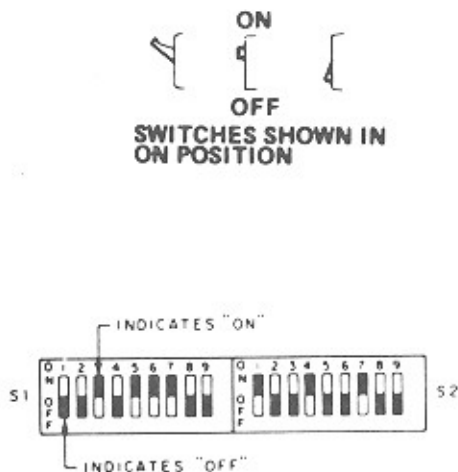
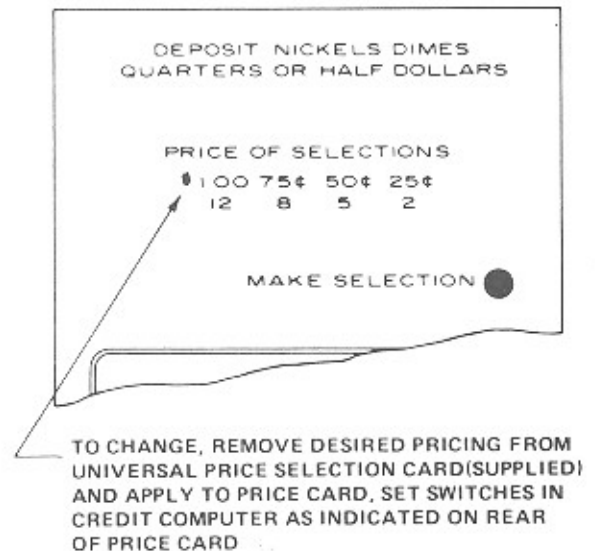

TABLE 2-1. PRICE OF PLAY PROGRAMMING



STANDARD PRICE CARD WITH SWITCH SETTINGS ON CREDIT COMPUTER



Insert coins and make selections to check proper operation.

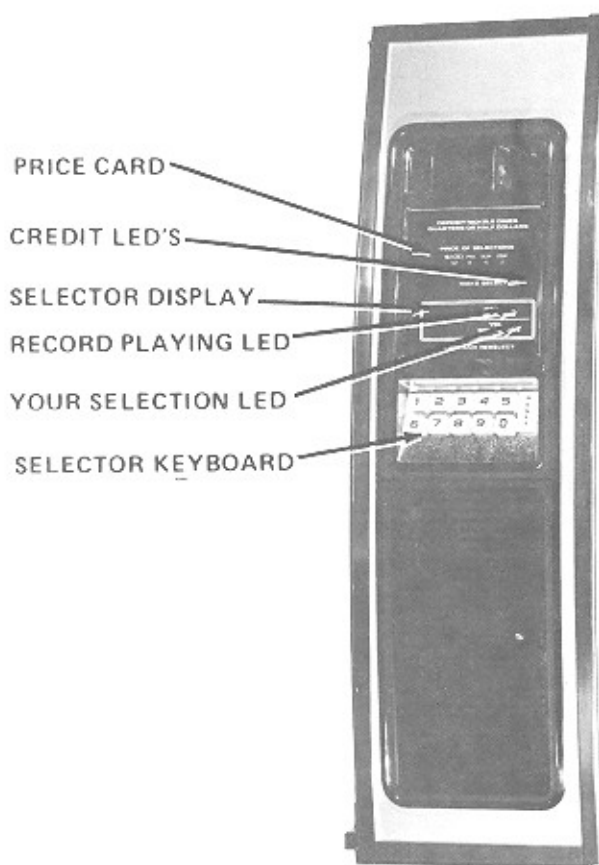
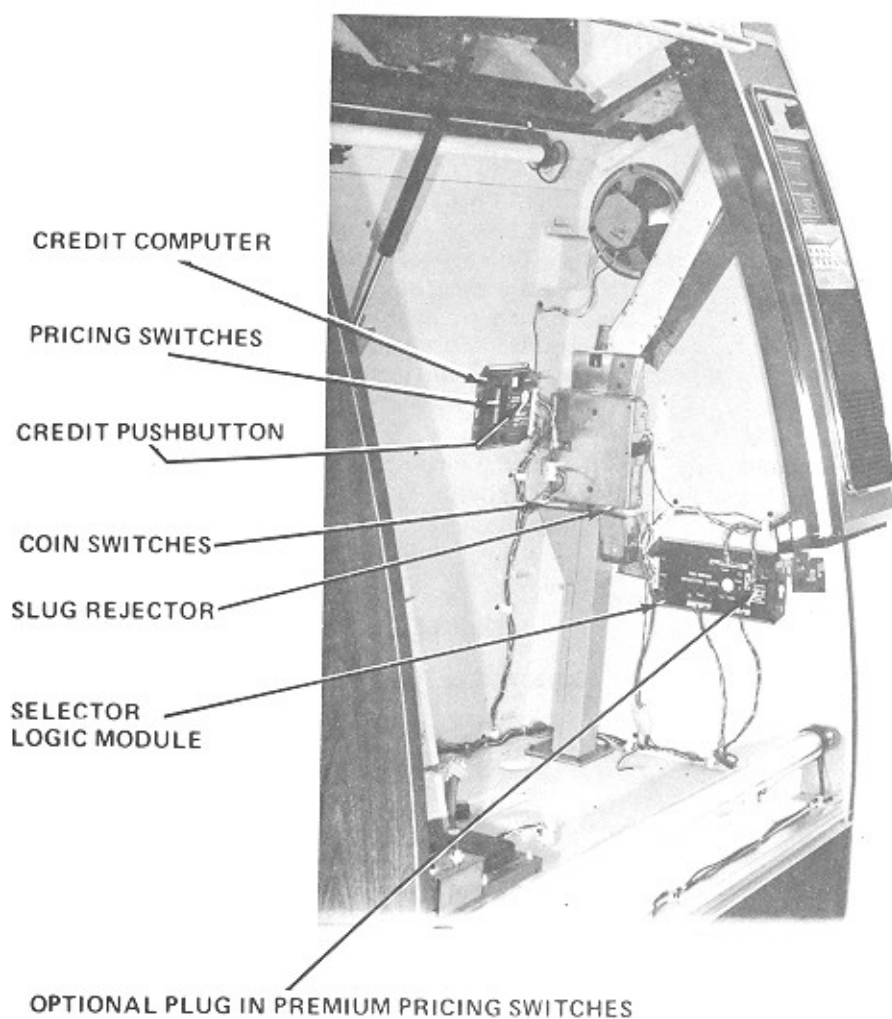
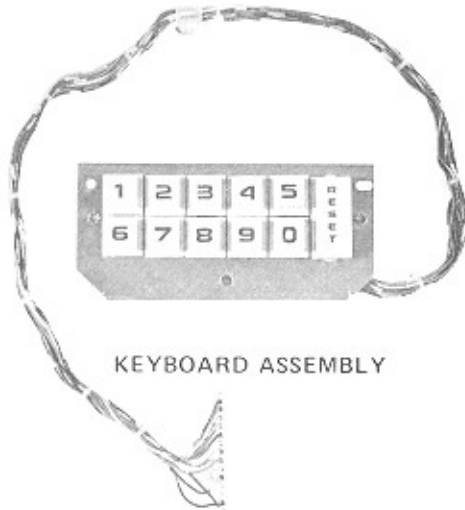
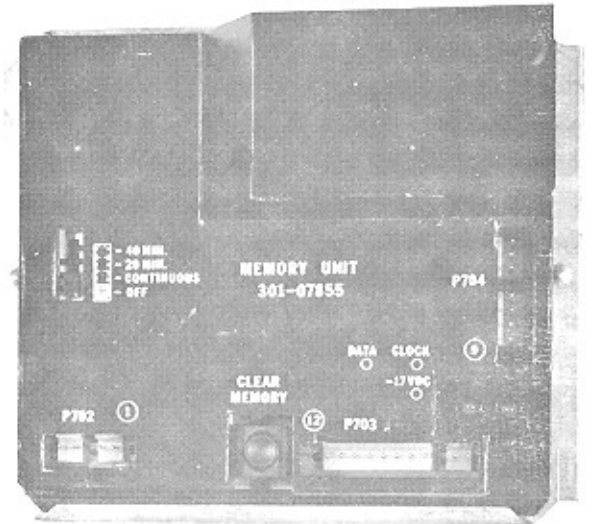

FIGURE 2-13 A CREDIT AND SELECTION SYSTEM MAJOR COMPONENTS



KEYBOARD ASSEMBLY



MEMORY UNIT

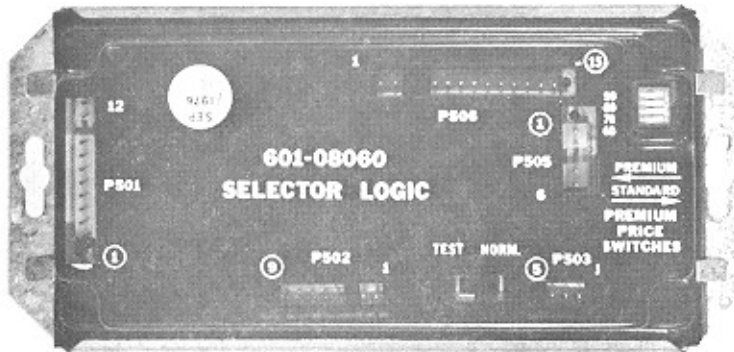

SELECTOR LOGIC MODULE

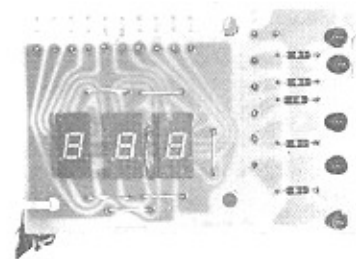

DIGITAL DISPLAY

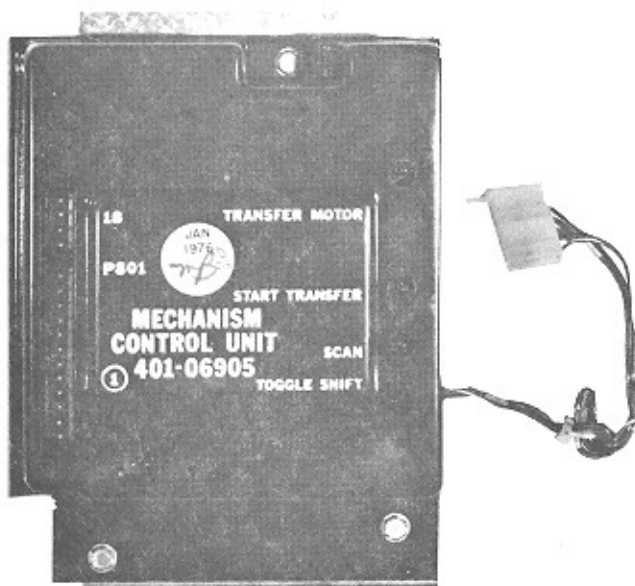

MECHANISM CONTROL UNIT



CREDIT COMPUTER

FIGURE 2-14. CREDIT AND SELECTION SYSTEM MAJOR COMPONENTS

THREE PRICE COIN MECHANISMS

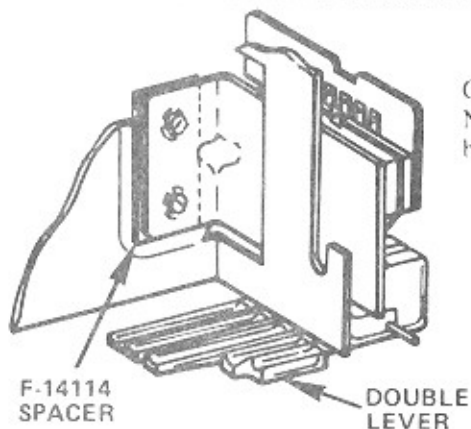

CA slug rejector can be interchanged with NRI slug rejector. F-14114 spacer must be used with CA for alignment.

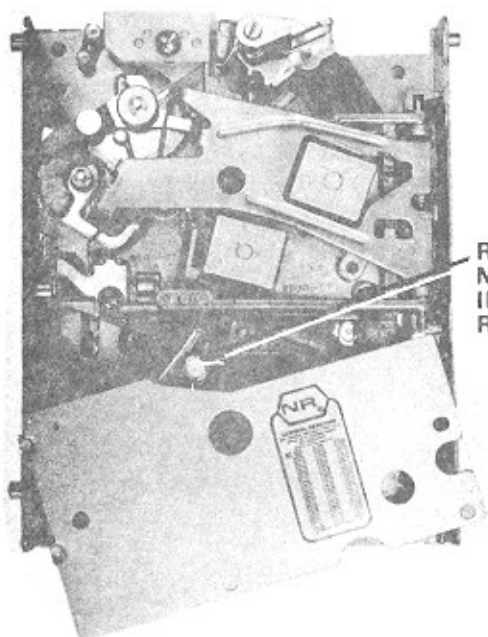
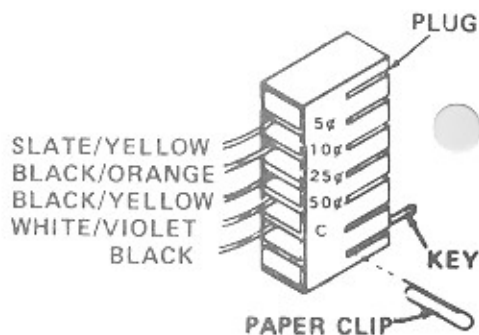

NATIONAL 3 COIN 402-06961

REMOVE COVER AND DRIVE No. 6-32 SELF-TAPPING SCREW INTO BOSS AS SHOWN TO REJECT NICKELS

MOVE THIS SCREW TO RIGHT TO REJECT DIMES (OR JUST FAR ENOUGH TO LEFT TO ACCEPT DIMES)

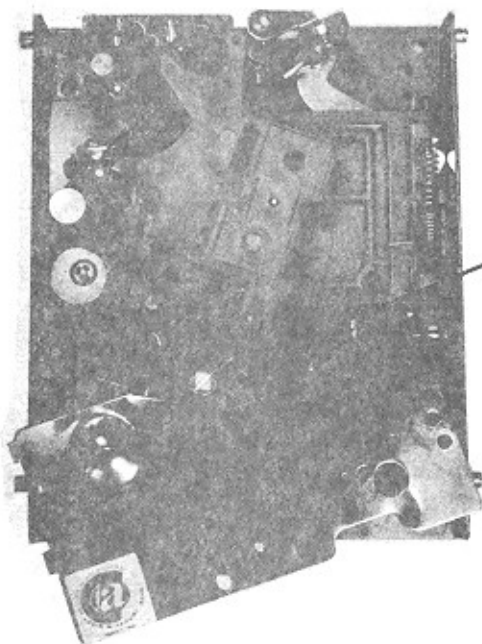
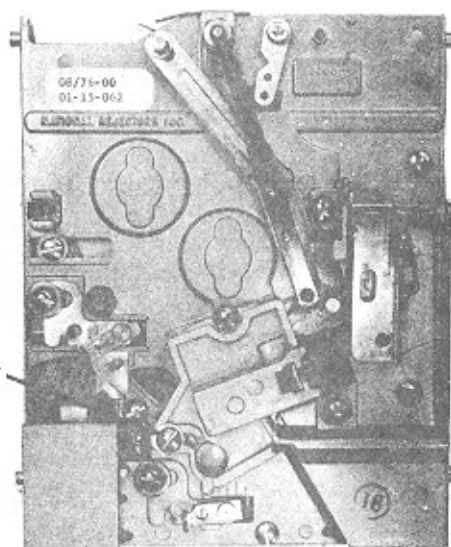

COIN ACCEPTORS 3 COIN 401-06961

REMOVE COVER AND DRIVE No. 6-32 SCREW INTO BOSS AS SHOWN TO REJECT NICKELS

MOVE THIS SCREW TO RIGHT TO REJECT DIMES (OR JUST FAR ENOUGH TO LEFT TO ACCEPT DIMES)

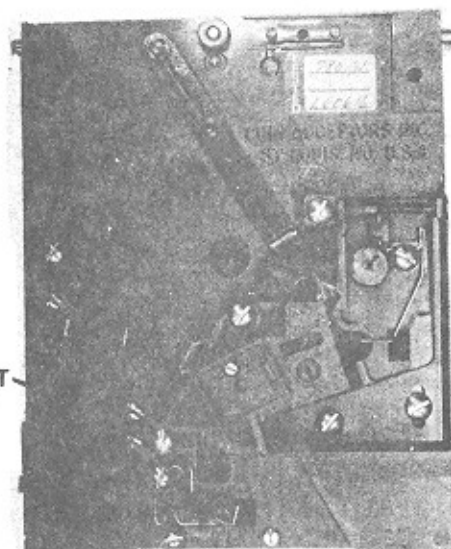

FOUR PRICE COIN MECHANISMS

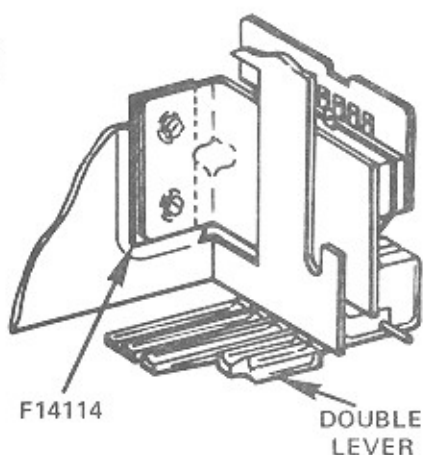

CA slug rejector can be interchanged with NRI slug rejector when coin switch has double width nickel lever. F-14114 spacer must be added for alignment when CA is used.

NOTE: Coin switch wiring in edge connector must be changed if rejectors are changed. To interchange black/orange and black/yellow wires, use tip of paper clip as tool. Press side of contact to release holding tab. Wire and contact can be pulled out. Tab may need reforming before reinsertion into edge connector.

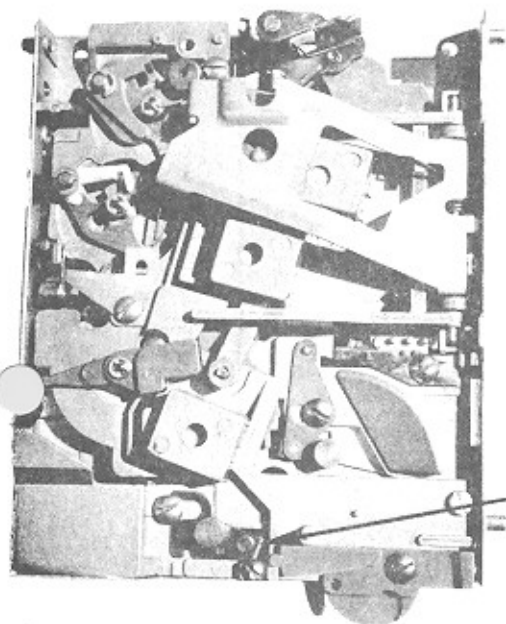
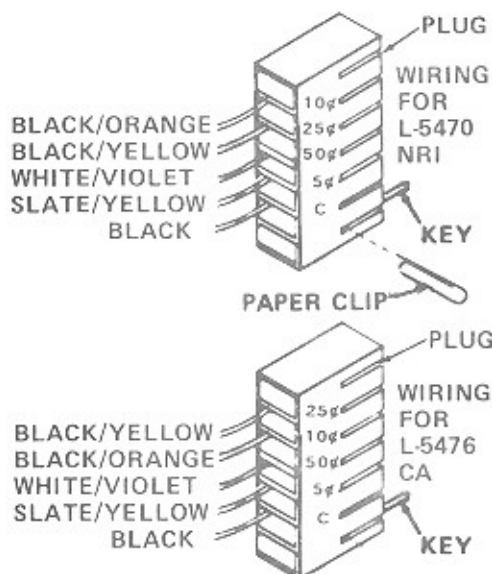

FRONT VIEW

NATIONAL

Move this screw to right to reject dimes (or just far enough to left to accept dimes).

Move this bracket to right to reject nickels (or just far enough to left to accept nickels).

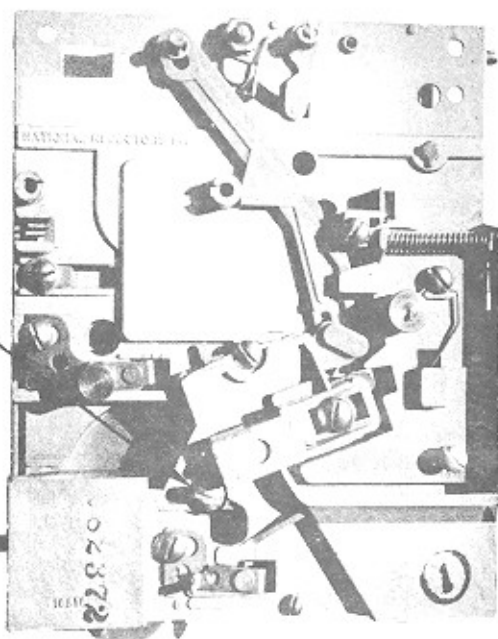

COIN ACCEPTORS

Move this screw to right to reject dimes (or just far enough to left to accept dimes).

Move this bracket to right to reject nickels (or just far enough to left to accept nickels).

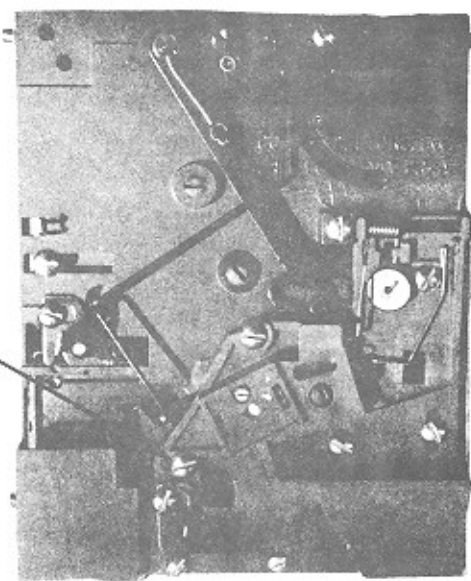
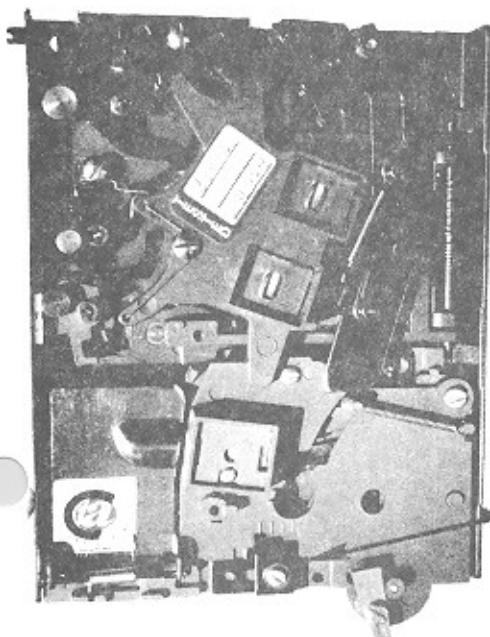

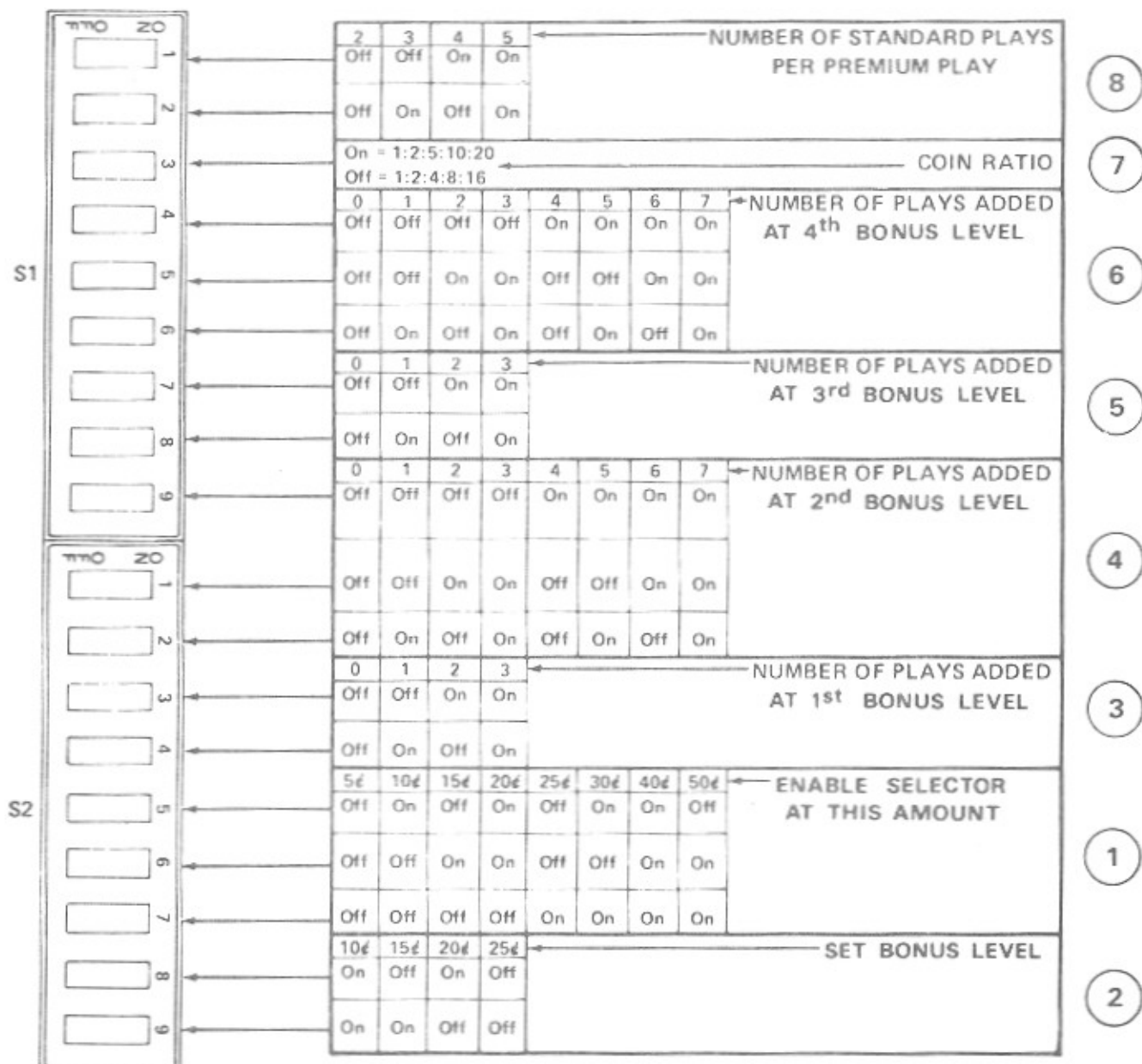

FIGURE 2-15. CREDIT COMPUTER PRICING SWITCHES AND THEIR FUNCTIONS

MAKING YOUR OWN PRICE COMBINATIONS

Pricing combinations other than those shown on the pricing charts are possible with the build-in flexibility of the Rowe Credit Computer.

Follow these steps:

- Determine the lowest amount of money that you want to turn on the selector, i.e. give just enough credit to light the "make standard selection" lamp.
Set switches S2-5, S2-6, and S2-7
- The setting in step (1) gave you one play per amount chosen. The first bonus level should be at that value or above. Determine the first bonus level. Generally this will be at 25¢ whether you actually add a bonus or not in step (3).
Set switches S2-8 and S2-9
- How many plays do you want to add at the first bonus level determined in step (2)?
Set switches S2-3 and S2-4
- The second bonus level is at two times the amount of the first bonus level. (If the first level is at 25¢ the second level is at 50¢). How many plays do you want to add at the second bonus level? Add up what you have so far and see how many more you want at this level.
Set switches S1-9, S2-1, and S2-2
- The third bonus level is at three times the amount of the first bonus level. How many plays do you want to add at the third bonus level? Add up what you have so far and add enough to give you what you want at this level.
Set switches S1-7 and S1-8
- The fourth bonus level is at four times the amount of the first bonus level. How many plays do you want to add at the fourth bonus level? Follow same procedure as before.
Set switches S1-4, S1-5, and S1-6
- Set coin ratio
1: 2: 5: 10: 20 Means 5¢, 10¢, 25¢, 50¢, \$1.00
Set switch S1-3
- Determine desired price of Album Play. This is set as a multiple of standard play.
Set switches S1-1 and S1-2

EXAMPLES

STANDARD SELECTIONS	ALBUM SELECTIONS
1 for 10¢	1 for 25¢
3 for 25¢	2* for 50¢
7 for 50¢	3** for 75¢
11 for 75¢	5 for \$1.00
15 for \$1.00	* Plus one standard play

STANDARD SELECTIONS	ALBUM SELECTIONS
2 for 25¢	1 for 25¢
5 for 50¢	2* for 50¢
9 for 75¢	4* for 75¢
14 for \$1.00	7 for \$1.00
	* Plus one standard play

	Step		Am't	Std.	Bonus	Cumulative Total
Enables selector at 10¢. Adds one credit for each 10¢ deposited.	1	S2-5 On S2-6 Off S2-7 Off	10¢ 20¢	1 1	0 0	1 2
Sets bonus levels at 25¢, 50¢, 75¢, and \$1.00	2	S2-8 Off S2-9 Off				
Adds one bonus credit at 1st bonus level (25¢)	3	S2-3 Off S2-4 On	25¢ 35¢ 45¢	0 1 1	1 0 0	3 4 5
Adds two bonus credits at 2nd bonus level (50¢)	4	S1-9 Off S2-1 On S2-2 Off	50¢ 60¢ 70¢	0 1 1	2 0 0	7 8 9
Adds two bonus credits at 3rd bonus level (75¢)	5	S1-7 On S1-8 Off	75¢ 85¢ 95¢	0 1 1	2 0 0	11 12 13
Adds two bonus credits at 4th bonus level (\$1.00)	6	S1-4 Off S1-5 On S1-6 Off	\$1.00	0	2	15
Sets coin ratio for U.S. coins.	7	S1-3 On				
Sets album play at 3x standard play	8	S1-1 Off S1-2 On				

	Step		Am't	Std.	Bonus	Cumulative Total
Enables selector at 25¢. Adds one credit for each 25¢ deposited.	1	S2-5 Off S2-6 Off S2-7 On				1
Sets bonus levels at 25¢, 50¢, 75¢, and \$1.00	2	S2-8 Off S2-9 Off				
Adds one bonus credit at 1st bonus level (25¢)	3	S2-3 Off S2-4 On	25¢	1	1	2
Adds two bonus credits at 2nd bonus level (50¢)	4	S1-9 Off S2-1 On S2-2 Off	50¢	1	2	5
Adds three bonus credits at 3rd bonus level (75¢)	5	S1-7 On S1-8 On	75¢	1	3	9
Adds four bonus credits at 4th bonus level (\$1.00)	6	S1-4 On S1-5 Off S1-6 Off	\$1.00	1	4	14
Sets coin ratio for U.S. coins.	7	S1-3 On				
Sets album play at 2x standard play	8	S1-1 Off S1-2 Off				

NOTE: Each time a bonus is added the standard play amount starts over at that level. If a bonus level is reached but no bonus is added the standard play amount ignores the bonus level.

For additional information, see Principles of Operation on page 2-54

PREMIUM PRICING

For premium pricing, an optional switch unit, part no. 702-00430, must be plugged into a receptacle on the selector logic module. Set selections 60 through 99 for premium (album) price, using premium pricing switches on selector logic module. Each switch represents 10 records (20 selections). Set switches for premium or standard price as desired. The test switch bypasses the credit computer, enabling phonograph operations for test purposes. It may also be used as a "free play" switch.

OPTIONAL PREMIUM PRICING SWITCHES

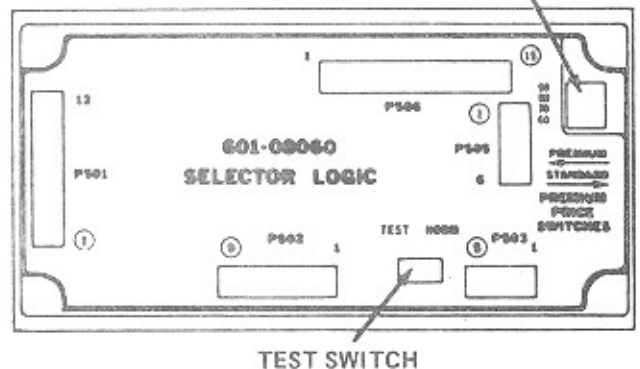

FIGURE 2-16. SWITCH LOCATIONS ON SELECTOR LOGIC MODULE

CREDIT COMPUTER TROUBLESHOOTING

The following troubleshooting procedures apply only to the 601-07674 Phonograph Credit Computer Assembly. The computer circuitry is designed around a single, non-repairable MOS chip, however the remainder of the components are discrete and can be replaced using circuit board soldering techniques described on page 2-3. To avoid damage to the computer while attempting repair, the unit should be returned to the factory if a qualified electronic technician is not available.

TEST EQUIPMENT

To aid in troubleshooting, the TE-475 Credit Computer Tester, is available. This unit provides a convenient, portable facility for operating the computer out of the phonograph cabinet. Credit is entered with pushbutton switches and accu-

mulated credit is displayed with light emitting diodes. Other test equipment required is as follows:

- Oscilloscope - Tektronix D66, or equivalent
- Voltmeter - Ballantine 3/24 DVM, or equivalent (1 Meg. or greater input impedance).

PRECAUTIONS

To avoid damage to the MOS chip by static electricity or current leakage, observe the following precautions:

- Use a soldering iron with a grounded tip.
- Do not repair computer in a carpeted area.
- Touch ground before touching the circuit board.

TROUBLESHOOTING PROCEDURE

Use the following chart to isolate and correct computer malfunctions:

CREDIT COMPUTER TROUBLESHOOTING CHART

TROUBLE	PROBABLE CAUSE	REMEDY
I. Any Trouble	Poor Solder Joints	Resolder
	-13 VDC Power Supply Faulty	Replace Zener Diode CR
	Oscillator not operating	Readjust R806, Replace C602 or Z601. Frequency must be $6.0 \pm .2$ KHz.
II. No Credit Established	Refer to cause in Section I.	
A. Credit established at Z601 output pin 2 and pin 12 of P601 but not at pin 13 of P601.	Defective Q602 or poor solder connection.	Replace Q602 or resolder connector pin.
B. Credit established at Z601 output pin 4 and pin 11 of P601 but not at pin 15 of P601.	Defective Q601 or poor solder connection	Replace Q601 or resolder connector pin.
C. Credit not established on Z601, pins 2 or 4.	Spurious ground on Z601 pins 12, 13, 14, 15, 16, 17 or 18 due to leaky capacitor C604, C605, C606, C607, C608, C609, C610 or C611; or faulty Z601.	Isolate cause to faulty component and replace.
III. Continuous Free Play	Refer to causes in Section I.	
A. Credit on Z601, pins 2 and 4 continuous at power turn on.	Spurious ground on Z601, pins 14-18 due to: 1. Shorting Wire 2. Short inside Z601.	Remove Short. Replace Z601.
B. Credit on Z601, pins 2 and 4 cannot be cancelled by cancel signals.	Cancel connections open. Leaky capacitor C606 or C607. Faulty Z601.	Solder connections. Replace capacitor. Replace Z601.
IV. Incorrect Credit	Refer to causes in Section I.	
	S602 and S603 set incorrectly	Reset switches S602 and S603.
	Z601 faulty.	Replace Z601.
V. Money pulses not generated at output.	Faulty Q603 or Q604.	Replace transistor Q603 or Q604.
	Z601 not generating pulses on pin 39.	Replace Z601.

160, 120, 100 SELECTION PROGRAMMING

Program the Phonograph for 160, 120, or 100 selection operation by grounding selector logic pins as follows:

TABLE 2-2. 160, 120, 100 SELECTION PROGRAMMING

Number of Selections	160	120	100
Connect the following Sel. Logic chip pins to ground (Pin 4)	39	40	39 and 40
Selections Played	100 to 179 200 to 279	First 6 of each group of 10, i.e., 100 to 105, 110 to 115, etc.	100 to 149 200 to 249
Switchable Premium Pricing	60 Group 70 Group	160 to 165 170 to 175 180 to 185 190 to 195 260 to 265 270 to 275 280 to 285 290 to 295	*None

*Premium pricing is possible for 100 selection operation by adding diodes, part no. 707-00350, to function in the same way as CR503 through CR506. For example, to premium price group 50, add a diode between pins 32 and 23 of the selector logic chip.

COIN SWITCH ADJUSTMENTS

For convenience, mount slug rejector on the bracket provided in front of the coin chute.

OPERATIONAL CHECK

1. Hold plastic coin switch lever in normal position and drop a coin through slug rejector.
2. When the coin comes to rest on the lever, release the lever slowly.
3. Check that the weight of the coin operates the lever enough to close the coin switch and allow the coin to fall free.
4. Repeat steps 1, 2 and 3 for other three levers.

CONTACT PRESSURE AND GAP

1. Check that each moving switch blade pushes against its lever with 7 to 8-grams force to hold lever against cushion. To adjust pressure, bend the blade near its mounting point.
2. Check that each non-moving blade pushes against its stiffener blade with 8- to 15-grams force. To adjust pressure, bend the contact blade near its mounting point.
3. Check that contact gap at switch with short double paddle is 0.030 to 0.035". Check that contact gap for long lever switches is 0.040 to 0.045 inch.

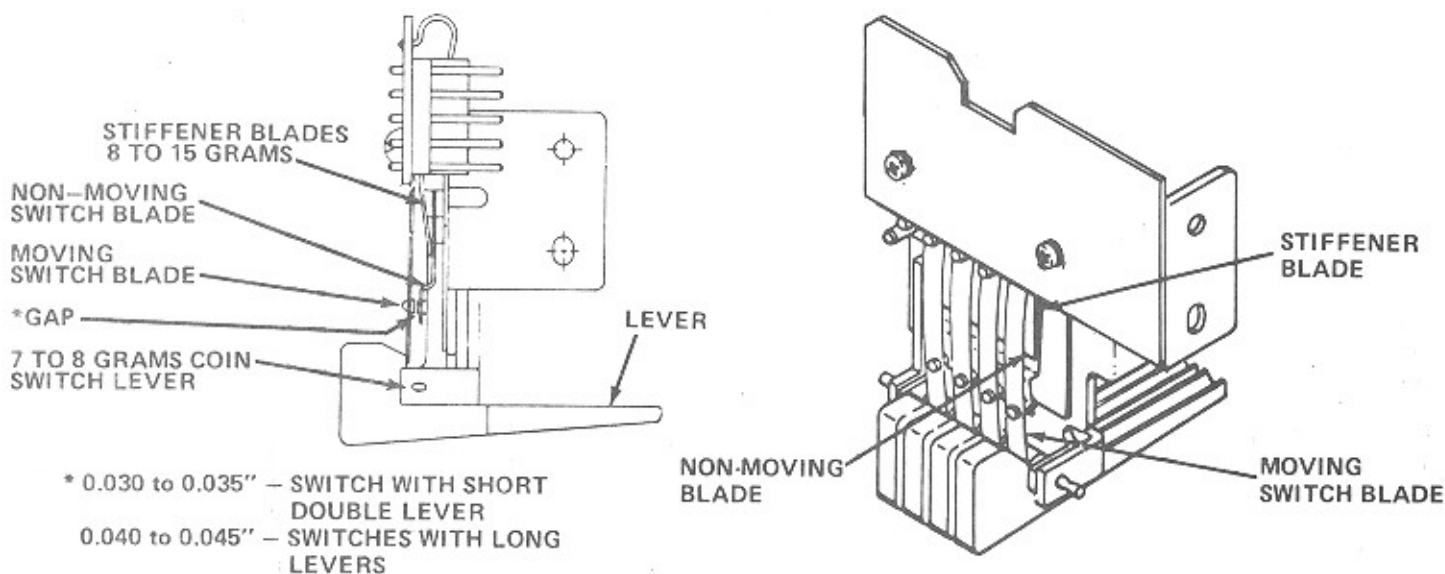

FIGURE 2-17. CONTACT PRESSURE AND GAP ADJUSTMENT

SELECTION SYSTEM OPERATION

The selection system permits the customer to choose desired selections after credit is established. The purpose of each selection system component is explained in the following paragraphs.

KEYBOARD ASSEMBLY (See figure 2-14)

The keyboard assembly is located on the selector panel just below the selector display window. It contains two rows of five selection pushbutton switches (1 through 5 and 6 through 0) and a RESET switch. The switches are mounted on a printed circuit board which plugs into the selector logic module on the rear wall of the cabinet.

SELECTOR LOGIC MODULE (See figure 2-14)

The selector logic receives circuit closures from the keyboard assembly and converts this data to binary form for transmission to the memory unit. The selection data is synchronized with an internal clock and transmitted as a pulse train at pin 26. Two red indicator lamps on the memory unit indicate the operation of the clock and data line.

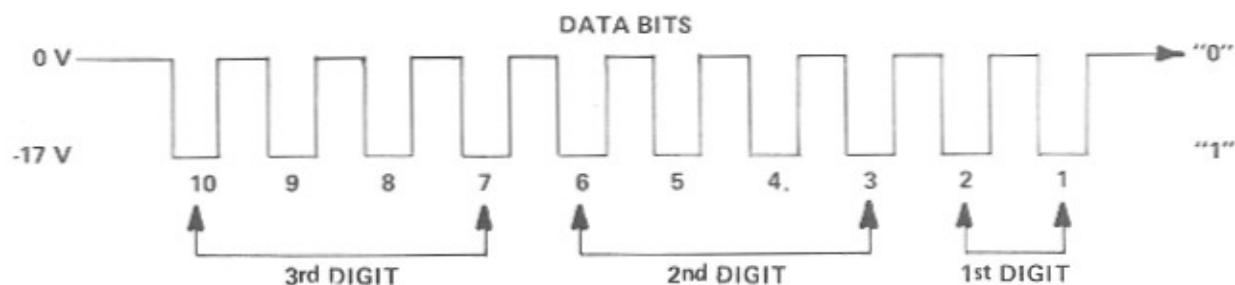

FIGURE 2-18. TEN BIT DATA PULSE TRAIN

Figure 2-18 shows a ten bit data pulse train. In this instance all bits are shown equal to "1" but for various selections, the bits may be combinations of "0"s and "1"s. The clock pulses are always equal to "1".

Table 2-3 shows how the data bits are arranged by the selector logic unit. Bits 1 and 2 indicate the source and if the record is a 100 selection or a 200 selection. The first selected digit must be either a 1 or a 2. Bits 3 through 6 carry the second digit information while bits 7 through 10 carry the third digit information. See table 2-4.

The selector logic module also incorporates rocker switches for premium pricing selections 60 through 99.

TABLE 2-3. FIRST DIGIT SELECTION

SELECTION	BITS COMING FROM	BIT NO.	
		1	2
2 X X	MEMORY	0	0
2 X X	SELECTOR	1	0
1 X X	SELECTOR	0	1
1 X X	MEMORY	1	1

TABLE 2-4. SECOND AND THIRD DIGIT SELECTION

DIGIT NUMBER	SECOND DIGIT BITS				THIRD DIGIT BITS			
	3	4	5	6	7	8	9	10
0	0	0	0	0	0	0	0	0
1	0	0	0	1	0	0	0	1
2	0	0	1	0	0	0	1	0
3	0	0	1	1	0	0	1	1
4	0	1	0	0	0	1	0	0
5	0	1	0	1	0	1	0	1
6	0	1	1	0	0	1	1	0
7	0	1	1	1	0	1	1	1
8	1	0	0	0	1	0	0	0
9	1	0	0	1	1	0	0	1

DIGITAL DISPLAY (See figure 2-16)

The digital display (annunciator) consists of three LED number display units soldered to a printed circuit board and harness. The display is operated by the selector logic.

Each number display unit consists of seven LED's. The displays are lit by a time multiplexing circuit. This means that the displays are lit or scanned one at a time from left to right. Due to the image retention ability of the human eye all three digits appear to be lit at once.

CREDIT SYSTEM OPERATION

The Rowe credit computer is a solid state credit system developed specifically for jukebox operation. Located on the middle of the rear wall of the phonograph, the credit computer accumulates credit for deposits up to 255 standard plays. There are no moving parts to wear out and no bonus relays, 2 quarter adapter, pulse chopper, 2 quarter wheel or such parts required. See "Setting Prices" in Section 2 for additional information.

Input signals are applied to the coin switch leads of the custom MOS circuit through appropriate interface circuits. One programming switch (S1-3) within credit computer permits these input signals to be weighted 1, 2, 5, 10, 20 (i.e. nickel, dime, quarter, half dollar, dollar) or to be weighted 1, 2, 4, 8, 16 (some foreign coin ratio such as 50 pf, 1 DM 2 DM).

As coins are deposited in acceptable denominations and in any sequence, deposits are weighted, by connection to specific input terminals, and deposit credit is accumulated.

When accumulated deposit credits equal or exceed the programmed price of play, credit chip provides an output signal to light standard play credit lamp ("Make Standard Selection"). It also provides an output enabling the phonograph selector.

When a standard selection is made by phonograph patron a "standard cancel" signal is generated which is applied to appropriate input of credit chip. The "Cancel" signal cancels or erases credit equivalent to programmed price of play.

It is also possible to accommodate premium (album) priced records through programming switches. When selections are made which are "premium" priced, the cancel signals will erase 2, 3, 4, or 5 accumulated play credits, depending on programming switch settings. Depending on the "premium" price programmed, credit chip has a premium selection output to enable premium selections and to light premium credit lamp ("Make any Selection"). When insufficient credit exists for "Premium" price programmed, premium selections are inhibited and "Make any Selection" lamp goes out.

The Credit Computer also provides an output signal which can be used with the Print-Out Money Meter. The money pulse signals from Credit Computer occur for each deposit, and appear as a series of pulses of Minimum Coin Value (MCV). For example, when a nickel is deposited (minimum

coin value) a single MCV pulse is provided to the money meter. When a dime is deposited, two (MCV) pulses occur. When a quarter is deposited, five (MCV) pulses occur. These pulses are registered by the money meter.

Slug Rejector and Coin Switches. The slug rejector takes good coins and rejects slugs and bad coins. It takes nickels, dimes, quarters and half-dollars.

The coin switches establish credit in the credit computer. They are located at the bottom of the slug rejector. They

are operated by the coins as they fall into the cash box. A good coin moves the switch lever, closing the switch and completing a circuit to the credit computer board.

Premium Pricing Switches. The optional premium pricing switches plug into the selector logic assembly. Each switch represents one number selection group and may be set for premium (album) price or regular price as desired. A test switch is also provided. This switch can be used as a "free play" switch.