

SEEBURG

UNIVERSAL PRICING UNIT, TYPE USPU1 & UDU1

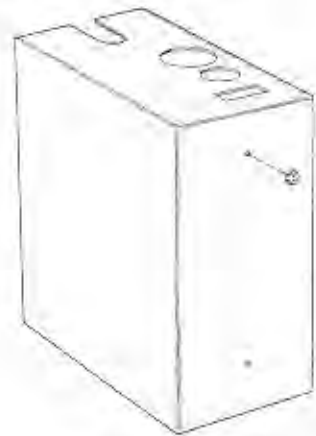
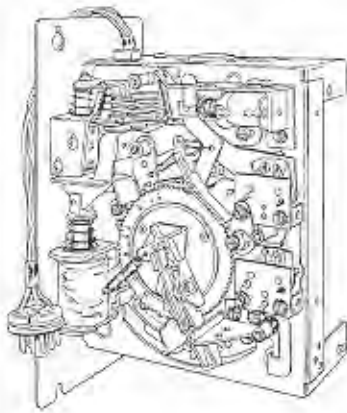

Pricing Unit Cover

The Universal Pricing Units are designed to be used with the Tormat Selection System. The Universal Single Pricing Unit, Type USPU1, is used when selections are sold for a single basic price. When selections are sold for two different basic prices, the Universal Dual Pricing Unit, Type UDU1, is used, or a Type USPU1 is used with an added E.P. solenoid and switch. The function of these Units is to store credits for coins deposited, cancel the credit as it is used for selections, control the selection system write-in current pulse, and start the scanning operation of the mechanism. The Unit consists of four add solenoids, one subtract solenoid, an E.P. solenoid (if dual pricing is used), two fuses, an add-hold magnet, a timing relay, and the switches that control the different circuits. Power for the operation is taken from a Tormat Selector Unit with which it is associated and to which it is connected with a cable and 12-pin plug.

The credit cancel switches are operated mechanically by a credit ratchet wheel which, in turn, is operated by the add and subtract solenoids. The credit wheel is a molded nylon ratchet with each tooth representing a 5 or 10¢ credit. This credit wheel is spring-loaded with the spring fully charged when there is no credit established. The credit wheel is retained in position by a detent lever. When a coin is deposited and an add solenoid is energized, the detent lever is disengaged from the teeth on the credit wheel to allow it to rotate. The number of positions or teeth it moves is determined by the 5-cent (single position) add lever or by the add arm whose travel is limited by the dime, quarter or half dollar stop. The subtract solenoid drives the credit wheel toward zero (no credit) position, positively recharging the spring.

Two fuses are used to protect the solenoids against excessive current flow caused by grounds or shorts in the circuits. One fuse is in the add solenoid circuit, the other in the subtract circuit.

Each time the nickel add solenoid is energized, the nickel add-one lever is engaged with the Credit Ratchet Wheel as the detent lever is disengaged. This allows the spring-loaded Credit Ratchet Wheel to move one position or tooth in a clockwise direction, thereby registering a nickel credit.

When the dime, quarter or half dollar add solenoid is energized, the add arm is engaged with the Credit Ratchet Wheel before the detent lever is disengaged. When the detent lever is completely disengaged, the spring-loaded Credit Ratchet Wheel moves in a clockwise direction until the add arm strikes the dime, quarter or half dollar stop. These stops are adjustable to provide a wide range of 5-cent credits for dimes, quarters or half dollars. The range of adjustments is:

Dime - 2, 3 or 4 nickel credits.

Quarter - 3, 4, 5, 6, 7 or 8 nickel credits.

Half Dollar - 5, 6, 7, 8, 9, 10, 11, 12, 13, 14 or 15 nickel credits.

The add-hold magnet is used in conjunction with the quarter and half dollar add solenoid. The purpose of the magnet is to hold the solenoids in the energized position for a sufficient time regardless of the time duration of the coin switch pulse. When a quarter or half dollar add solenoid is energized, a magnet plate is mechanically pulled against the add-hold magnet and a condenser switch operates to discharge a 100 mfd condenser through the add-hold magnet. The condenser has been charged by DC from the TSU. The magnet is energized for approximately 80 milliseconds, holding the magnet plate and the add solenoid in the energized position.

UNIVERSAL PRICING UNIT, Type USPU1 & UDPUI

The subtract operation of the Universal Single Pricing Unit is accomplished by one subtract coil mechanically driving a subtract pawl against the credit wheel. Variations in the prices of selections are accomplished by physically altering the angle of approach of the subtract pawl with respect to the credit wheel. This is done by means of a guide plate that determines the rest position of the subtract pawl. The Unit is designed so selections can be sold for 5 cents, or 10 cents or 15 cents.

When the Universal Single Pricing Unit is to

be converted for dual pricing, an EP assembly is mounted in the Unit by means of two screws and connected electrically by means of five wires soldered to a terminal strip in the Unit. This assembly is adjusted so that the EP arm positions the subtract pawl to drive the credit ratchet wheel the proper number of teeth for the minimum pricing. When an EP selection is made, the EP solenoid is energized, moving the EP arm away from the subtract pawl so that the guide plate on the Pricing Unit will position the subtract pawl to drive the Credit Ratchet Wheel the proper number of teeth for an EP price.

Contact Adjustments

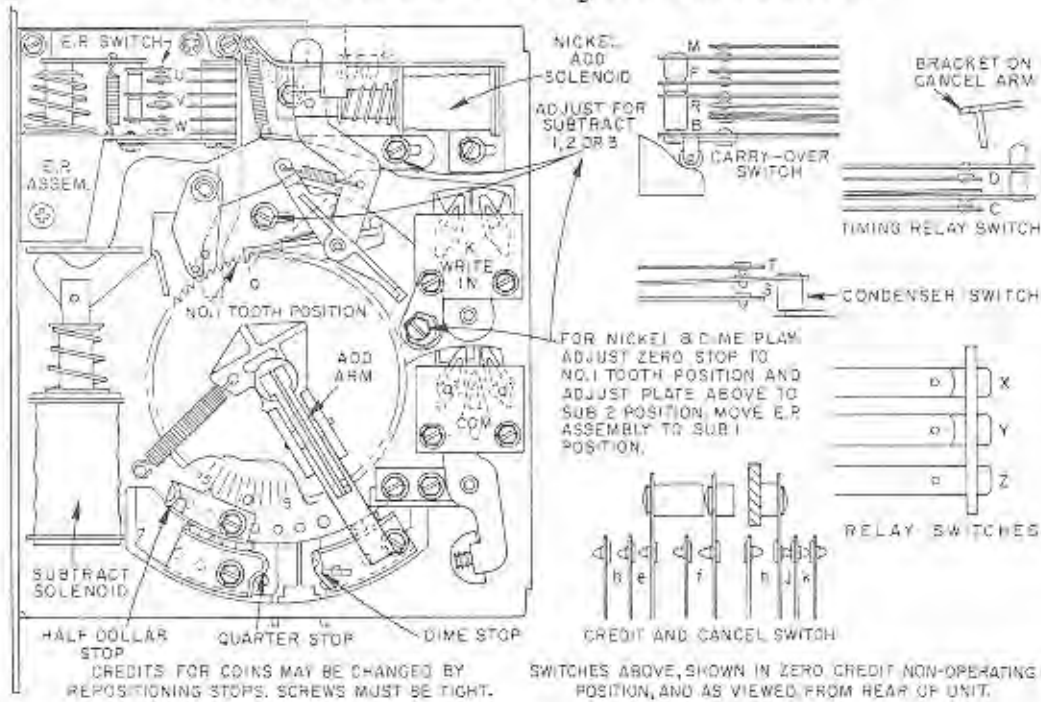

CONTACT DATA

CONTACT	GAP	PRESSURE	NORMAL POSITION	CONTACT	GAP	PRESSURE	NORMAL POSITION
B	.025 .035	25 GRAM	NORM OPEN	"a" and "d"	—	15 GRAM AGAINST SEGMENT	NORM OPEN
R	.015 .030	25 GRAM	NORM CLOSED	"b"	.020 AT 2 .015 CREDIT	20 GRAM	CLOSED AT 3 OR MORE CREDITS
F	.010 MIN.	25 GRAM	NORM OPEN	"e"	.020 AT 1 .020 CREDIT	25 GRAM	CLOSED AT 2 OR MORE CREDITS
M	.010 MIN.	25 GRAM	NORM OPEN	"f"	.015 AT 1 .020 CREDIT	20 GRAM	CLOSED AT 2 OR MORE CREDITS
C	.015 .030	30 GRAM	NORM OPEN	"h"	.010 AT 2 .015 CREDIT	20 GRAM	CLOSED AT 3 OR MORE CREDITS
D	.015 .030	30 GRAM	NORM OPEN	"j"	.010 AT 3 .015 CREDIT	20 GRAM	OPENS AT 3 OR MORE CREDITS
T	.015	20 GRAM	NORM CLOSED	"k"	.010 AT 2 .020 CREDIT	20 GRAM (WITH ONE CREDIT)	OPENS AT 2 OR MORE CREDITS
S	.015	20 GRAM	NORM OPEN	U	.015	25 GRAM	NORM OPEN
X	.015 .025	45 GRAM	NORM CLOSED	V	.025 MIN.	25 GRAM	NORM OPEN
Y	.015 .025	45 GRAM	NORM CLOSED	W	.015	25 GRAM	NORM OPEN
Z	.015 .025	45 GRAM	NORM OPEN				
K	—	15 GRAM AGAINST SEGMENT	NORM OPEN				

NOTE: E.P. assembly including E.P. switch and contact data for contacts U, V and W are not used on Type USPU1.

UNIVERSAL PRICING UNIT, Type USPU1 & UDU1

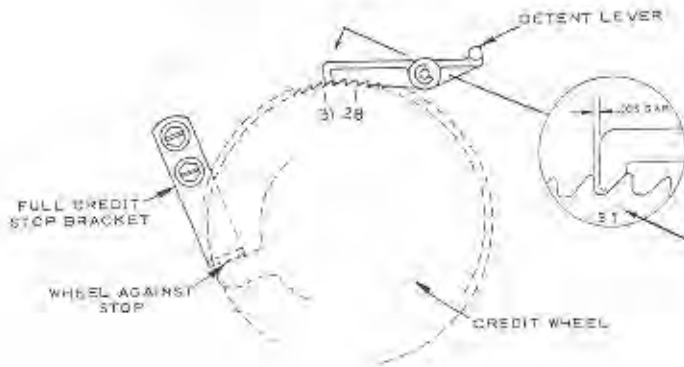

MAXIMUM CREDIT POSITION

With Credit Wheel biased against the Full Credit Stop Bracket, adjust stop bracket so there is .005 clearance between the tip of the Detent Lever and the face of tooth No. 31.

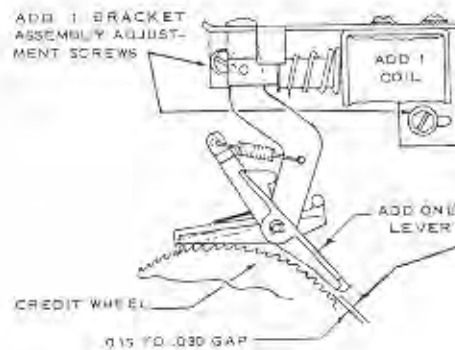

ADD 1 ASSEMBLY

Position Add 1 Bracket Assembly so there is .015 to .030 clearance between the Add One Lever and the tips of the teeth on the Credit Wheel.

ADD 1 COIL

NOTE: Add 1 Assembly Adjustment should be correct before making this adjustment.

Position Add 1 Coil.

With the coil plunger fully seated in the Add 1 Coil, provide a .015 to .030 clearance between the Detent Lever and the tips of the teeth in the Credit Wheel.

Do not permit the Detent Release Lever to bottom in the slot of the Solenoid Bracket Assembly.

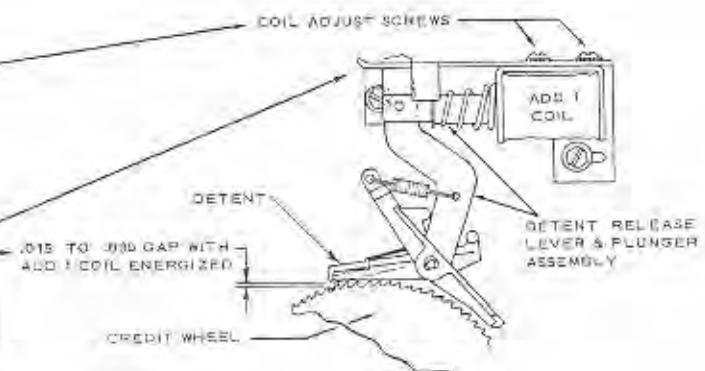

ADD ARM STOP BRACKET

With Dime Stop Bracket set to Add 2, move Add Arm to Dime Stop and engage with Credit Wheel. While engaged, move the Add Arm to the right until two teeth of the Credit Wheel passes the Detent Lever. Holding the arm in this position shift the Add Arm Stop Bracket so it touches the Add Arm at point "X" and tighten screws.

Check that Add Arm engages teeth of Credit Wheel smoothly; this may require slight readjustment of Stop Bracket.

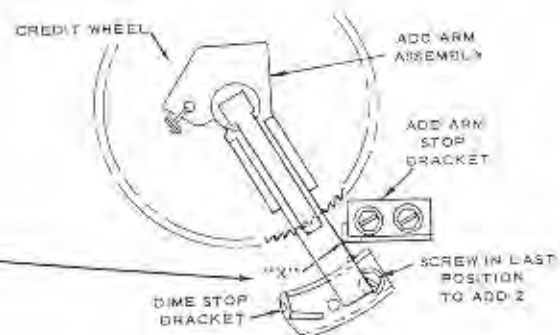

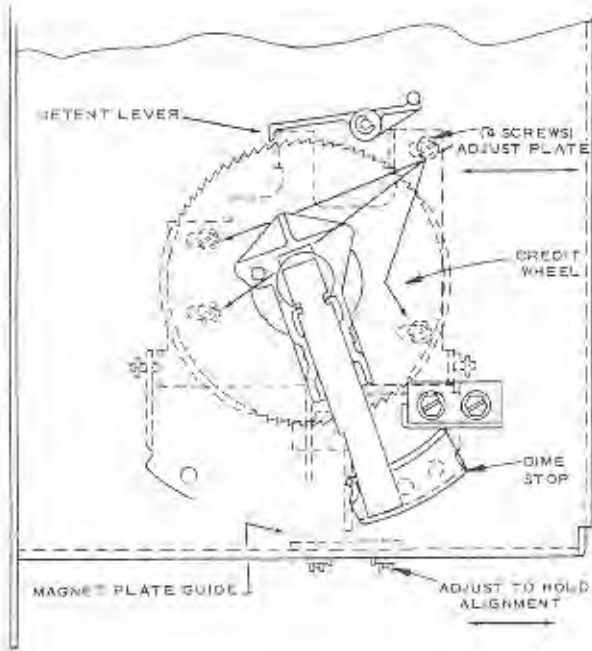

HINGE PLATE AND MAGNET PLATE GUIDE

Operate Add 2 plunger and check detent lever operation to see that detent lever falls freely into teeth. If detent strikes on tooth or rubs slightly, shift hinge plate in rear to permit free operation of the Add 2.

Check magnet plate for smooth operation in magnet plate guide.

DETENT RELEASE LEVER

Adjust Detent Release Lever.

When plungers on Dime, Quarter and Half Dollar solenoids are operated, Detent Lever should clear tips of teeth on Credit Wheel by .015 to .030.

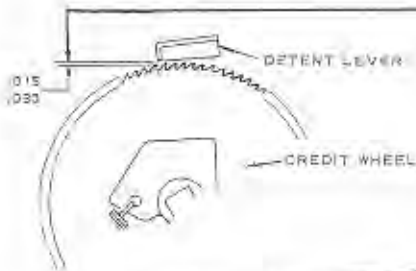
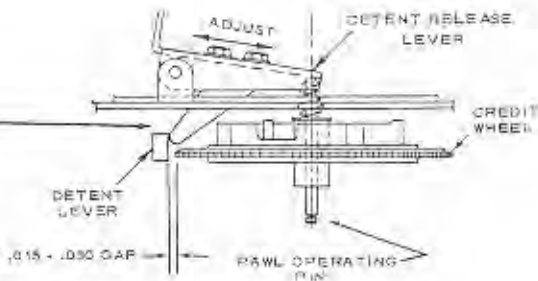

ADD DIME, QUARTER AND HALF DOLLAR ASSEMBLY

Adjust the Dime, Quarter and Half Dollar solenoid positions so there is .015 to .030 clearance between the Detent Lever and the tip of the teeth on the Credit Wheel when the respective solenoid plungers are fully seated.

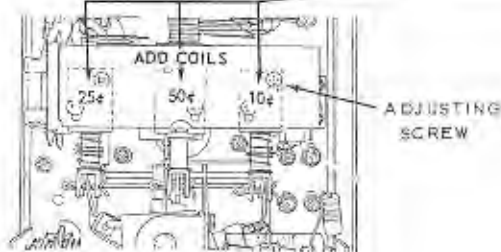

UNIVERSAL PRICING UNIT, Type USPUI & UDPUI

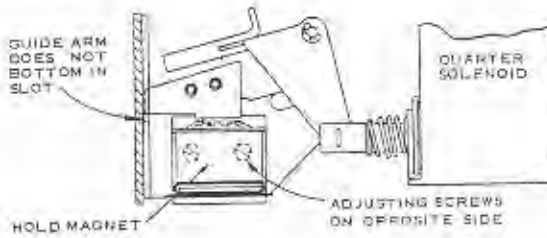

HOLD MAGNET

With the plunger of the Quarter Solenoid bottomed, adjust the position of the Hold Magnet so that the magnet plate is just touching the pole piece of the Hold Magnet.

SUBTRACT SOLENOID ASSEMBLY

With the Subtract Solenoid Plunger bottomed, adjust Subtract Solenoid position so there is a maximum of .008 clearance between the Subtract Pawl and the Pawl Stop, and a minimum of .010 clearance between the tip to the Detent Lever and the face of a tooth on the Credit Wheel.

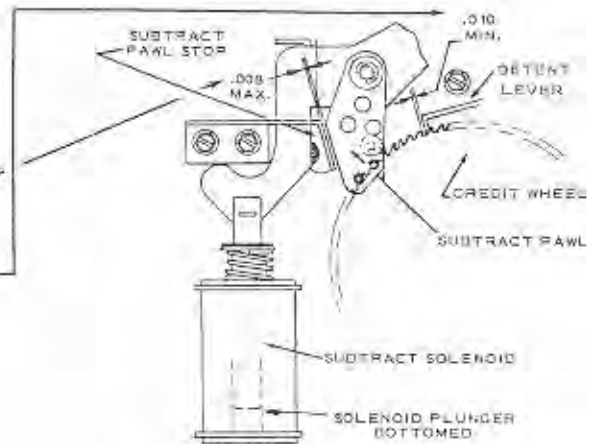

ADD ARM SPRING FORCES

NOTE: These springs are not adjustable, but are given here to determine normal operation of the Add Arm. The Add Arm, operating arm and springs are available only as a complete riveted assembly, Part No. 451049.

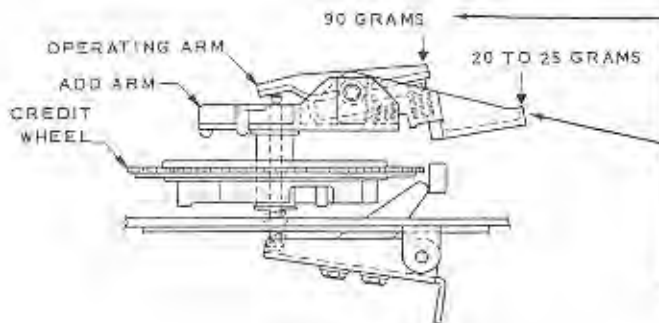

A force of 20 to 25 grams applied at the tip of the Add Arm should be sufficient to start arm downward. Measure with Add Arm away from stop bracket.

Holding the Add Arm engaged with the Credit Wheel, a force of 90 grams applied at the tip of the operating arm should start the operating arm downward.

UNIVERSAL PRICING UNIT, Type USPU1 & UGPU1

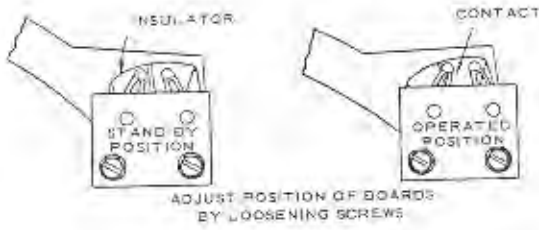

WRITE-IN CONTACTS

Adjust Terminal Board so that contact on left is just about to make when Cancel Arm is moved down far enough so pin engages Credit Wheel.

CREDIT LAMP SWITCH

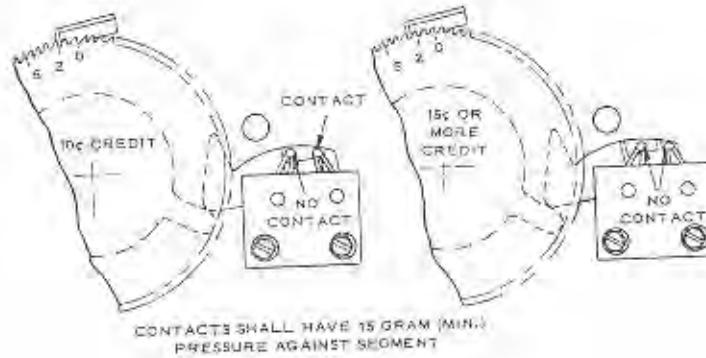
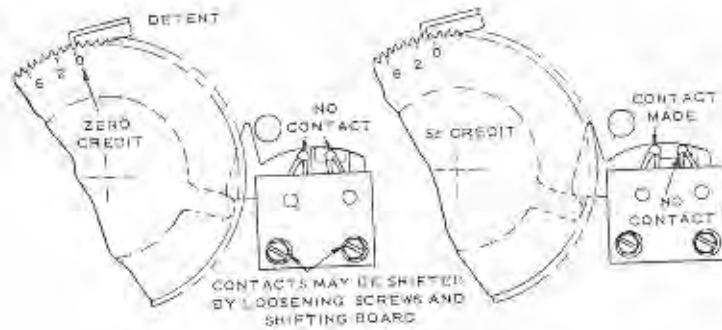

PRICING COMBINATION ADJUSTMENTS













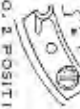

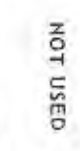
The value in mixed coins that can be accumulated is dependent upon premiums given for Quarters and Half Dollars. Example of accumulated value is shown below for pricing combinations of:

5¢ play, 6 for Quarter, 14 for Half Dollar or
10¢ play, 3 for Quarter, 7 for Half Dollar.

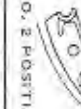
\$1.50 for any combination of Nickels and Dimes; \$1.25 for 5 Quarters; \$1.10 for 2 Half Dollars & 2 Nickels (or 1 Dime);

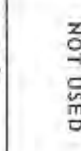
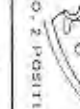
\$1.25 for 1 Half Dollar, 1 Quarter and any combination of Nickels and Dimes totalling 50¢.

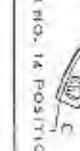
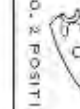
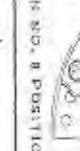
The table below constitutes a chart condensing information regarding the capabilities and set-up requirements for seven (7) popular pricing combinations. Adjust the Pricing Unit as indicated in the chart, below, and illustrated in Adjustments, on page 16048.

PRICING WINDOW	ADD STOP POSITIONS			ZERO STOP	SUBTRACT PAWL	SLUG REJECTOR	COIN SWITCH JUMPER			
	DIME	QUARTER	HALF DOLLAR							
<table border="1"> <tr> <td>QUARTER SELECTIONS 5 SELECTIONS</td> <td>5¢¹⁰⁰ SELECTION</td> <td>HALF DOLLAR SELECTIONS 11 SELECTIONS</td> </tr> </table>	QUARTER SELECTIONS 5 SELECTIONS	5¢ ¹⁰⁰ SELECTION	HALF DOLLAR SELECTIONS 11 SELECTIONS				POSITION 2	POSITION 1	POSITION 1	POSITION 1
QUARTER SELECTIONS 5 SELECTIONS	5¢ ¹⁰⁰ SELECTION	HALF DOLLAR SELECTIONS 11 SELECTIONS								
IN NO. 2 POSITION	IN NO. 5 POSITION	IN NO. 11 POSITION								
<table border="1"> <tr> <td>5¢¹⁰⁰ SELECTION</td> <td>QUARTER SELECTIONS 6 SELECTIONS</td> <td></td> </tr> </table>	5¢ ¹⁰⁰ SELECTION	QUARTER SELECTIONS 6 SELECTIONS					POSITION 2	POSITION 1	POSITION 1	POSITION 1
5¢ ¹⁰⁰ SELECTION	QUARTER SELECTIONS 6 SELECTIONS									
IN NO. 2 POSITION	IN NO. 6 POSITION	IN NO. 13 POSITION	NOT USED							
<table border="1"> <tr> <td>QUARTER SELECTIONS 6 SELECTIONS</td> <td>5¢¹⁰⁰ SELECTION</td> <td>HALF DOLLAR SELECTIONS 13 SELECTIONS</td> </tr> </table>	QUARTER SELECTIONS 6 SELECTIONS	5¢ ¹⁰⁰ SELECTION	HALF DOLLAR SELECTIONS 13 SELECTIONS				POSITION 2	POSITION 1	POSITION 1	POSITION 1
QUARTER SELECTIONS 6 SELECTIONS	5¢ ¹⁰⁰ SELECTION	HALF DOLLAR SELECTIONS 13 SELECTIONS								
IN NO. 2 POSITION	IN NO. 6 POSITION	IN NO. 13 POSITION	NOT USED							
<table border="1"> <tr> <td>10¢¹⁰⁰ SELECTION</td> <td>QUARTER SELECTIONS 3 SELECTIONS</td> <td></td> </tr> </table>	10¢ ¹⁰⁰ SELECTION	QUARTER SELECTIONS 3 SELECTIONS					POSITION 1	POSITION 2	POSITION 1	POSITION 1
10¢ ¹⁰⁰ SELECTION	QUARTER SELECTIONS 3 SELECTIONS									
IN NO. 2 POSITION	IN NO. 3 POSITION	NOT USED	NOT USED							
<table border="1"> <tr> <td>QUARTER SELECTIONS 3 SELECTIONS</td> <td>10¢¹⁰⁰ SELECTION</td> <td>HALF DOLLAR SELECTIONS 7 SELECTIONS</td> </tr> </table>	QUARTER SELECTIONS 3 SELECTIONS	10¢ ¹⁰⁰ SELECTION	HALF DOLLAR SELECTIONS 7 SELECTIONS				POSITION 1	POSITION 2	POSITION 1	POSITION 1
QUARTER SELECTIONS 3 SELECTIONS	10¢ ¹⁰⁰ SELECTION	HALF DOLLAR SELECTIONS 7 SELECTIONS								
IN NO. 2 POSITION	IN NO. 7 POSITION	IN NO. 14 POSITION	NOT USED							
<table border="1"> <tr> <td>10¢¹⁰⁰ SELECTION</td> <td>QUARTER SELECTIONS 4 SELECTIONS</td> <td></td> </tr> </table>	10¢ ¹⁰⁰ SELECTION	QUARTER SELECTIONS 4 SELECTIONS				NOT USED	POSITION 1	POSITION 2	POSITION 1	POSITION 1
10¢ ¹⁰⁰ SELECTION	QUARTER SELECTIONS 4 SELECTIONS									
IN NO. 2 POSITION	IN NO. 8 POSITION	NOT USED	NOT USED							
<table border="1"> <tr> <td>HALF DOLLAR SELECTIONS 4 SELECTIONS</td> <td>10¢¹⁰⁰ SELECTION</td> <td>HALF DOLLAR SELECTIONS 5 SELECTIONS</td> </tr> </table>	HALF DOLLAR SELECTIONS 4 SELECTIONS	10¢ ¹⁰⁰ SELECTION	HALF DOLLAR SELECTIONS 5 SELECTIONS	NOT USED			POSITION 2	POSITION 1	POSITION 2	POSITION 2
HALF DOLLAR SELECTIONS 4 SELECTIONS	10¢ ¹⁰⁰ SELECTION	HALF DOLLAR SELECTIONS 5 SELECTIONS								
NOT USED	IN NO. 4 POSITION	IN NO. 9 POSITION	NOT USED							

PRICING COMBINATION ADJUSTMENTS

SUBTRACT PAWL AND GUIDE PLATE:

POSITION NO. 1

- A. Advance Credit Wheel so detent lever is engaged with tooth No. 6.
- B. Loosen two screws on subtract pawl guide plate.
- C. Position guide plate so, when subtract solenoid operates, the subtract pawl enters tooth No. 13 without striking the sides of the tooth.
- D. Tighten screws on guide plate.



POSITION NO. 2

- A. Advance Credit Wheel so detent lever is engaged with tooth No. 6.
- B. Loosen two screws on subtract pawl guide plate.
- C. Position guide plate so, when subtract solenoid operates, the subtract pawl enters tooth No. 12 without striking the sides of the tooth.
- D. Tighten screws on guide plate.



ZERO STOP:

POSITION NO. 1

- A. Remove lock plate. Loosen screw on zero credit stop and rotate stop so the long radius of the eccentric post is facing away from the Credit Wheel.
- B. Engage detent lever with No. 0 tooth on Credit Wheel.
- C. Bias the wheel against the stop.
- D. Adjust stop position so there is slight clearance between the tip of the detent lever and the face of the No. 0 tooth.
- E. Replace lock plate and tighten screws.

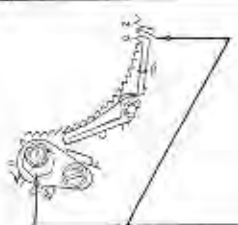

POSITION NO. 2

- A. Engage detent lever with No. 1 tooth on Credit Wheel.
- B. Remove lock plate. Loosen screw on zero credit stop and rotate stop so the long radius of the eccentric post is facing the Credit Wheel.
- C. Bias the wheel against the stop.
- D. Adjust stop position so there is slight clearance between the tip of the detent lever and the face of the No. 1 tooth.
- E. Replace lock plate and tighten screws.

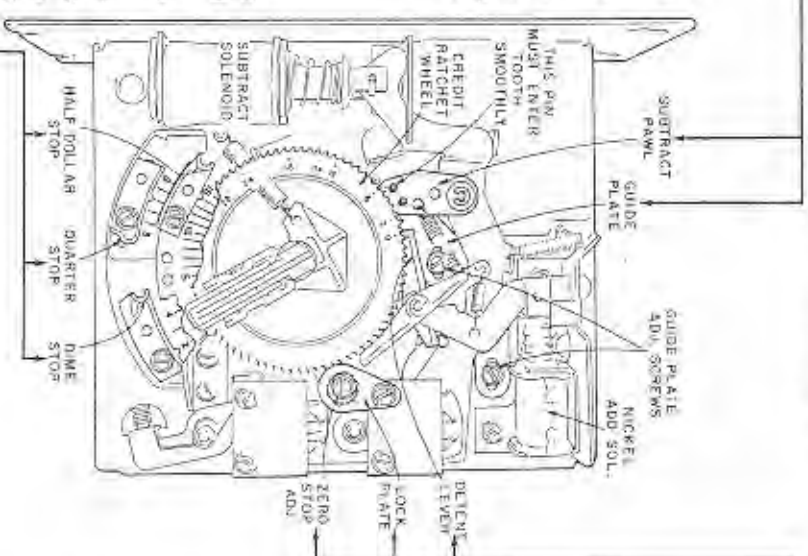

COIN SWITCH JUMPER:

POSITION NO. 1

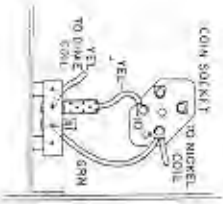

POSITION NO. 2

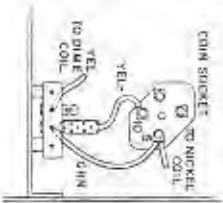

SLUG REJECTOR:

POSITION NO. 1

- A. Remove screw from stop.
- B. Shift stop to desired position using pointer on stop as indicator.
- C. Replace and tighten screw.

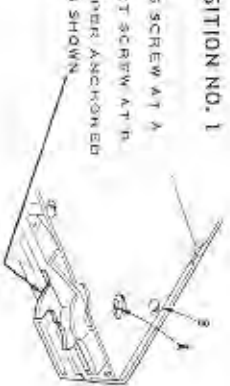

POSITION NO. 2

- A. Remove screw from stop.
- B. Shift stop to desired position using pointer on stop as indicator.
- C. Replace and tighten screw.



PRICING COMBINATION ADJUSTMENTS

















The value in mixed coins that can be accumulated is dependent upon premiums given for Quarters and Half Dollars. Example of accumulated value is shown below for pricing combinations of:

5¢ play, 6 for Quarter, 14 for Half Dollar or
10¢ play, 3 for Quarter, 7 for Half Dollar.

\$1.50 for any combination of Nickels and Dimes; \$1.25 for 5 Quarters; \$1.10 for 2 Half Dollars & 2 Nickels (or 1 Dime);

\$1.25 for 1 Half Dollar, 1 Quarter and any combination of Nickels and Dimes Totalling 50¢.

The table below constitutes a chart condensing information regarding the capabilities and set-up requirements for seven popular pricing combinations. The first four (4) are for dual pricing. The last three (3) are for single pricing. Adjust the Pricing Unit as indicated in the chart below and illustrated in Page 16050.

PRICING WINDOW	ADD STOP POSITIONS			ZERO STOP	E.P. PAWL POSITION LEVER	PAWL GUIDE PLATE	SLUG REFLECTOR	COIN SWITCH JUMPER				
	DIME	QUARTER	HALF DOLLAR									
<table border="1"> <tr> <td>5¢ per 10 SELECTIONS</td> <td>QUARTER 6 SELECTIONS</td> <td>10¢ per 10 SELECTIONS</td> <td>QUARTER 14 SELECTIONS</td> </tr> </table>	5¢ per 10 SELECTIONS	QUARTER 6 SELECTIONS	10¢ per 10 SELECTIONS	QUARTER 14 SELECTIONS			NOT USED	POSITION 8	POSITION 1	POSITION 2	POSITION 1	POSITION 1
5¢ per 10 SELECTIONS	QUARTER 6 SELECTIONS	10¢ per 10 SELECTIONS	QUARTER 14 SELECTIONS									
<table border="1"> <tr> <td>10¢ per 10 SELECTIONS</td> <td>QUARTER 14 SELECTIONS</td> <td>10¢ per 10 SELECTIONS</td> <td>QUARTER 21 SELECTIONS</td> </tr> </table>	10¢ per 10 SELECTIONS	QUARTER 14 SELECTIONS	10¢ per 10 SELECTIONS	QUARTER 21 SELECTIONS				POSITION 8	POSITION 1	POSITION 2	POSITION 1	POSITION 1
10¢ per 10 SELECTIONS	QUARTER 14 SELECTIONS	10¢ per 10 SELECTIONS	QUARTER 21 SELECTIONS									
<table border="1"> <tr> <td>10¢ per 10 SELECTIONS</td> <td>QUARTER 14 SELECTIONS</td> <td>15¢ per 10 SELECTIONS</td> <td>QUARTER 21 SELECTIONS</td> </tr> </table>	10¢ per 10 SELECTIONS	QUARTER 14 SELECTIONS	15¢ per 10 SELECTIONS	QUARTER 21 SELECTIONS			NOT USED	POSITION 1	POSITION 2	POSITION 3	POSITION 1	POSITION 1
10¢ per 10 SELECTIONS	QUARTER 14 SELECTIONS	15¢ per 10 SELECTIONS	QUARTER 21 SELECTIONS									
<table border="1"> <tr> <td>10¢ per 10 SELECTIONS</td> <td>QUARTER 14 SELECTIONS</td> <td>15¢ per 10 SELECTIONS</td> <td>QUARTER 21 SELECTIONS</td> </tr> </table>	10¢ per 10 SELECTIONS	QUARTER 14 SELECTIONS	15¢ per 10 SELECTIONS	QUARTER 21 SELECTIONS				POSITION 1	POSITION 2	POSITION 3	POSITION 1	POSITION 1
10¢ per 10 SELECTIONS	QUARTER 14 SELECTIONS	15¢ per 10 SELECTIONS	QUARTER 21 SELECTIONS									
<table border="1"> <tr> <td>10¢ per 10 SELECTIONS</td> <td>QUARTER 14 SELECTIONS</td> <td>15¢ per 10 SELECTIONS</td> <td>QUARTER 21 SELECTIONS</td> </tr> </table>	10¢ per 10 SELECTIONS	QUARTER 14 SELECTIONS	15¢ per 10 SELECTIONS	QUARTER 21 SELECTIONS			NOT USED	POSITION 1	POSITION 2	POSITION 3	POSITION 1	POSITION 1
10¢ per 10 SELECTIONS	QUARTER 14 SELECTIONS	15¢ per 10 SELECTIONS	QUARTER 21 SELECTIONS									
<table border="1"> <tr> <td>10¢ per 10 SELECTIONS</td> <td>QUARTER 14 SELECTIONS</td> <td>15¢ per 10 SELECTIONS</td> <td>QUARTER 21 SELECTIONS</td> </tr> </table>	10¢ per 10 SELECTIONS	QUARTER 14 SELECTIONS	15¢ per 10 SELECTIONS	QUARTER 21 SELECTIONS	NOT USED			POSITION 2	POSITION 1	POSITION 3	POSITION 2	POSITION 3
10¢ per 10 SELECTIONS	QUARTER 14 SELECTIONS	15¢ per 10 SELECTIONS	QUARTER 21 SELECTIONS									
<table border="1"> <tr> <td>10¢ per 10 SELECTIONS</td> <td>QUARTER 14 SELECTIONS</td> <td>15¢ per 10 SELECTIONS</td> <td>QUARTER 21 SELECTIONS</td> </tr> </table>	10¢ per 10 SELECTIONS	QUARTER 14 SELECTIONS	15¢ per 10 SELECTIONS	QUARTER 21 SELECTIONS				POSITION 2	POSITION 1	POSITION 2	POSITION 1	POSITION 1
10¢ per 10 SELECTIONS	QUARTER 14 SELECTIONS	15¢ per 10 SELECTIONS	QUARTER 21 SELECTIONS									

SUBTRACT PAWL GUIDE PLATE:

- A. Advance Credit Wheel so detent lever is engaged with tooth No. 6.
- B. Loosen two screws on subtract pawl guide plate.
- C. Move "E.P." Pawl Position Lever away from the subtract pawl and position the subtract pawl guide plate for:

POSITION NO. 3; so the subtract pawl enters tooth No. 11 when subtract solenoid operates.



POSITION NO. 2; so the subtract pawl enters tooth No. 12 when subtract solenoid operates.

E.P. PAWL POSITION LEVER

- A. Advance Credit Wheel so detent lever is engaged with tooth No. 6.
- B. Loosen two screws on "E.P." assembly.
- C. Position E.P. Assembly for:

POSITION NO. 2; so the subtract pawl enters tooth No. 12 when subtract solenoid operates.



POSITION NO. 1; so the subtract pawl enters tooth No. 13 when subtract solenoid operates.

COIN SWITCH JUMPER:

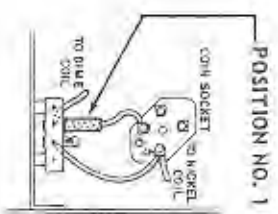

POSITION NO. 1

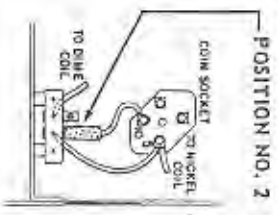

POSITION NO. 2

PRICING COMBINATION ADJUSTMENTS

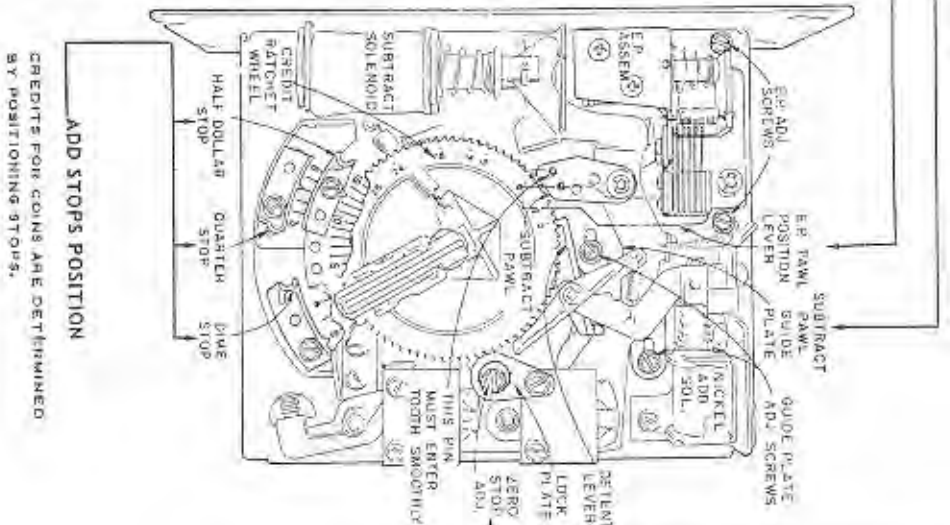

ZERO STOP:

- A. Remove lock plate. Loosen screw on zero credit stop and rotate stop so the long radius of the eccentric post is facing away from the Credit Wheel.
- B. Engage detent lever with No. 0 tooth on Credit Wheel.
- C. Bias the wheel against the stop.
- D. Adjust stop position so there is slight clearance between the tip of the detent lever and the face of the No. 0 tooth.
- E. Replace lock plate and tighten screws.

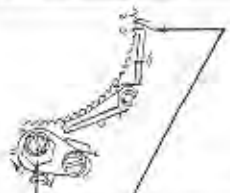

POSITION NO. 1

POSITION NO. 2

- A. Engage detent lever with No. 1 tooth on Credit Wheel.
- B. Remove lock plate. Loosen screw on zero credit stop and rotate stop so the long radius of the eccentric post is facing the Credit Wheel.
- C. Bias the wheel against the stop.
- D. Adjust stop position so there is slight clearance between the tip of the detent lever and the face of the No. 1 tooth.
- E. Replace lock plate and tighten screws.

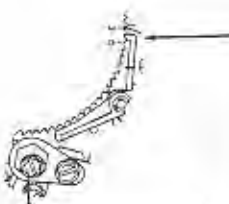

SLUG REJECTOR:

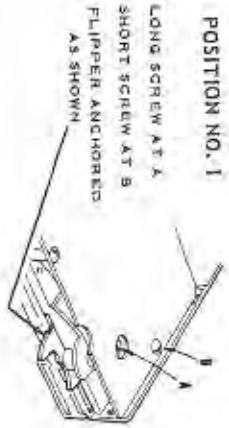

POSITION NO. 1



POSITION NO. 2

UNIVERSAL PRICING UNIT, Type USPUI and UDPUI

DRAWING NO. 451155

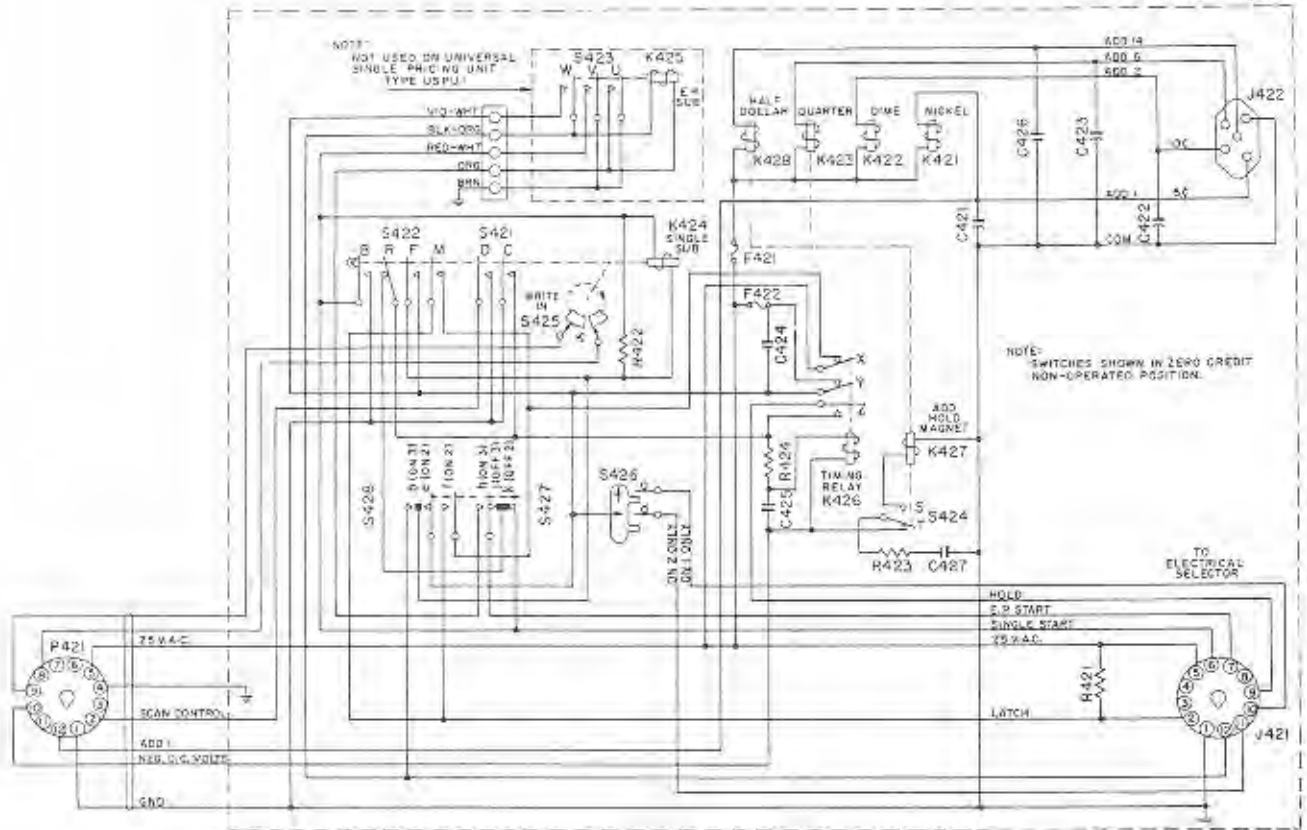

Schematic Diagram for Universal Pricing Unit, Type USPUI and UDPUI

PARTS LIST

Item	Part No.	Description	Item	Part No.	Description
C421	86259	.02 MFD Ceramic	K426	451228	Timing Relay
C422	86259	.02 MFD Ceramic	K427	451234	Hold Magnet Assem.
C423	86259	.02 MFD Ceramic	K428	451218	Solenoid Assem. (Half Dollar)
C424	86259	.02 MFD Ceramic	P421	410707	Plug 12 Prong
C425	86142	.1 MFD 200 V.	R421	82707	Resistor 1.2K 1W.
C426	86258	.04 MFD Ceramic	R422	82838	Resistor 100 Ohm 2W.
C427	87695	100 MFD 50 V. Electrolytic	R423	82403	Resistor 18 Ohm 1/2W.
F421	503636	Fuse 1/2 amp. Slo Blo	R424	82686	Resistor 150 Ohm 1W.
F422	451248	Fuse 1-5/10 amp. Slo Blo	S421	451204	Switch (Timing Relay)
J421	201275	Socket 12 Contact	S422	451115	Switch (Carry-over)
J422	450735	Socket 5 Contact	S423	451342	Switch (E.P.)
K421	451068	Solenoid Assem. (Nickel)	S424	451141	Switch (Condenser)
K422	451068	Solenoid Assem. (Dime)	S425	451098	Write In Switch
K423	451068	Solenoid Assem. (Quarter)	S426	451111	Credit Lamp Switch
K424	451094	Solenoid Assem. (Cancel)	S427	451114	Cancel Circuit Switch
K425	451343	Solenoid Assem. (E.P.)	S428	451220	Credit Circuit Switch