

General Coverage Communications Receiver

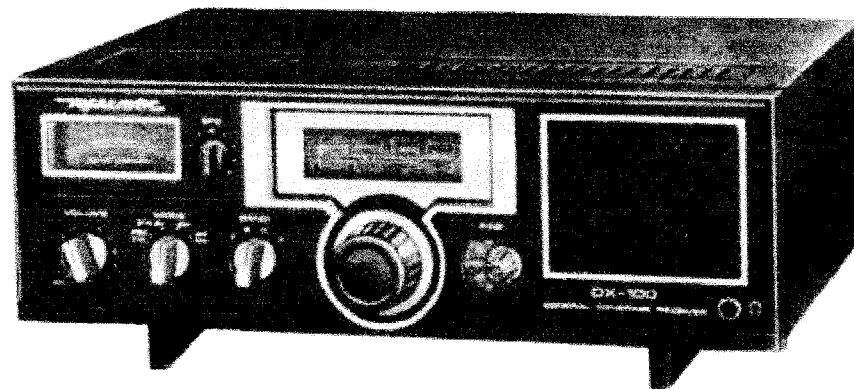

DX-100

OWNER'S
MANUAL

PLEASE READ BEFORE
USING THIS EQUIPMENT

REALISTIC

CUSTOM MANUFACTURED FOR RADIO SHACK  A TANDY CORPORATION COMPANY

CAT NO.
20-200

**... It All Comes Alive on Your Realistic
DX-100 General Coverage Communications Receiver**

The entire world is at your fingertips with the Realistic DX-100. English language broadcasts can be heard from such world capitals as London, Tokyo, Paris, Rome, Berlin and Moscow. Exotic music and unusual languages can be heard from stations located in distant, isolated sections of the world. Airplanes, both civilian and military, use radio to keep in touch on intercontinental flights. Radio amateurs (commonly known as "hams") can be heard chattering away around the clock with friends located in the next town or on the other side of the world.

Your DX-100 is designed to tune a wide variety of signals from 520 kHz to 30 MHz. It receives AM (Amplitude modulation), CW (Continuous wave, better known as Morse code) and SSB (Single sideband) signals. It has superb sensitivity and selectivity to dig out distant and low-powered stations.

The circuitry is all solid-state, built on rugged printed circuit boards. This insures maximum reliability. The combination of modern circuit design and top-quality 3" (6 cm) permanent magnet dynamic speaker provides superior sound reproduction. A full complement of controls, plus a telescoping antenna and provision for an external antenna, assure you of greatest enjoyment of your new Shortwave Receiver.

You can use the DX-100 at home (on 120 Volts, 60 Hz AC) or in your car or vehicle (12 Volts DC negative or positive ground).

Main features are:

- * Continuous frequency coverage from 520 kHz to 30 MHz
- * BFO control for SSB and CW reception
- * External Antenna terminal for superior reception on shortwave bands (B, C, D)
- * Rotary switch and large dial window with red cursor for convenient frequency selection
- * 30" 75 cm telescoping swivel-mount antenna for shortwave reception
- * Fine Tuning for precise tuning on all bands
- * AC or DC (negative or positive ground) operation
- * All-silicon solid-state circuitry for maximum circuit efficiency with minimum noise
- * Audio power IC provides high intelligibility sound
- * Built-in Ferrite Loopstick antenna for AM band
- * Headphone jack for communications type headphones (1/4" 6.35 mm plug)

For your own protection, we urge you to record the Serial Number of this unit in the space provided. You'll find the Serial Number on the back panel of the unit.

Serial Number

WARNING: TO PREVENT FIRE OR SHOCK HAZARD, DO NOT EXPOSE THIS RADIO TO RAIN OR MOISTURE.

GETTING TO KNOW YOUR DX-100

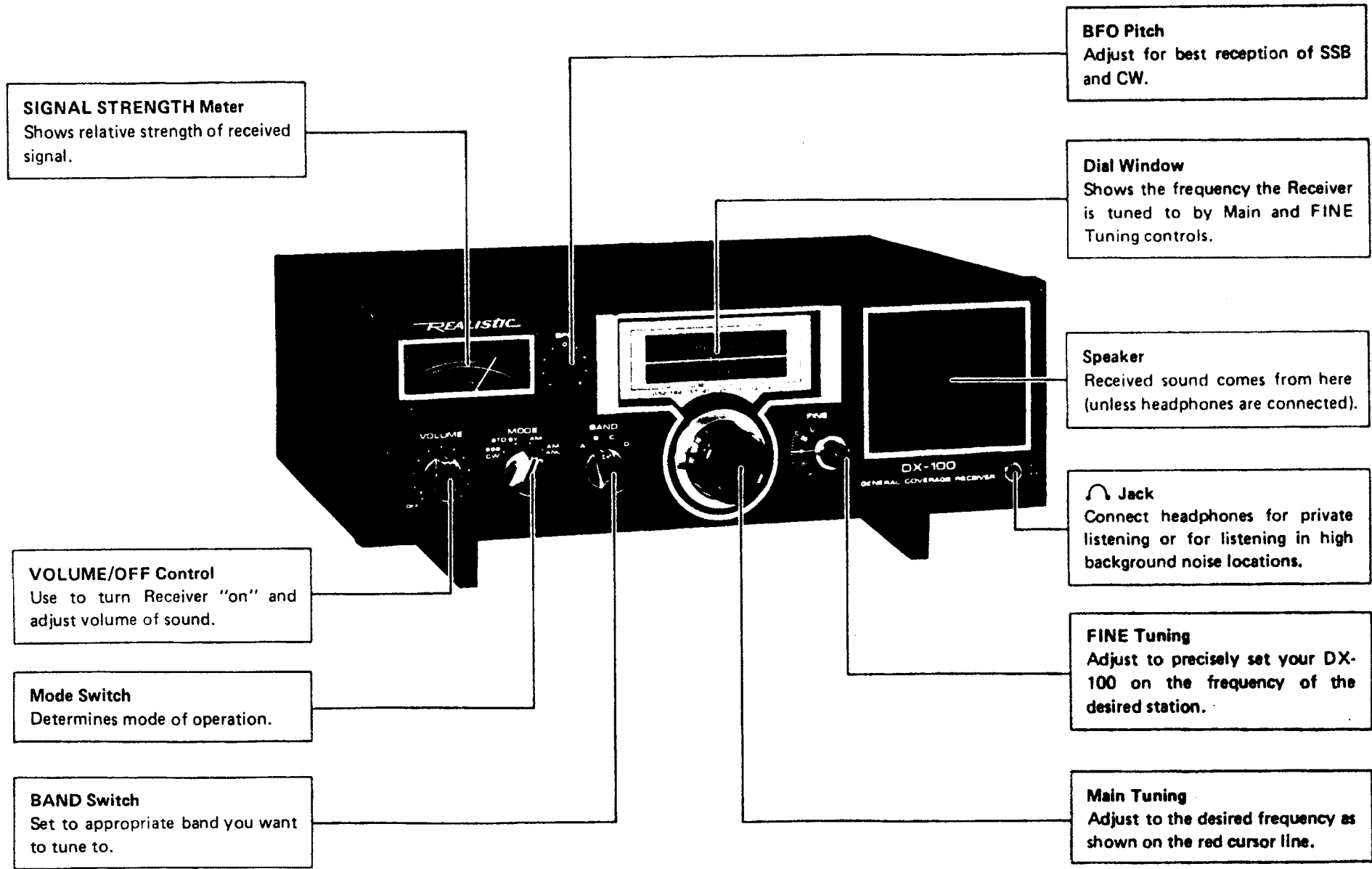

Telescopic Antenna Holder

Telescopic Antenna
Must be extended fully for best reception on shortwave (unless an external antenna is used).

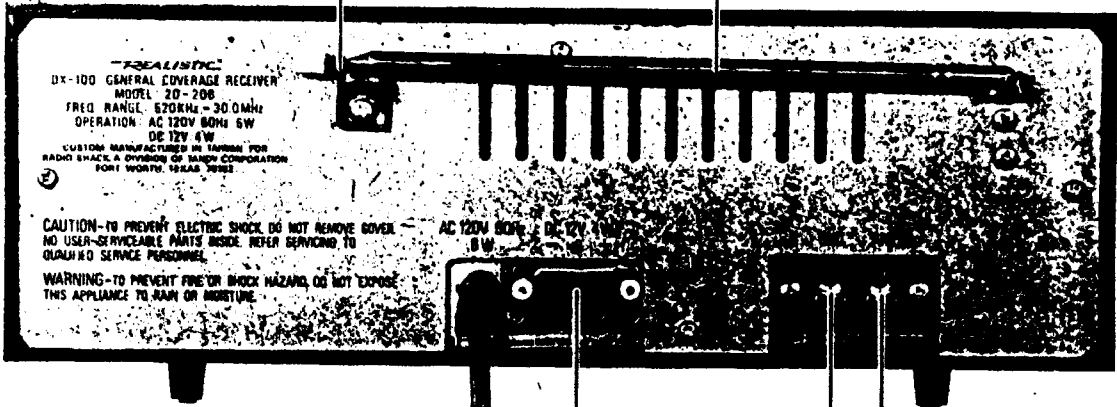

Power Cord
Connect to a source of 120 Volts,
60 Hz AC power.

ANTenna Screw Terminal
Connect long-wire antennas to this
screw terminal.

DC 12 V Jack
For operation from an external
source of 12 volts DC. Use cable
supplied for connection. Be sure
to connect + to +, - to -.

GND Screw Terminal
Connect a wire to a cold water
pipe or other electrical "ground"
point (often will aid reception).

INSTALLING YOUR RECEIVER

Your Realistic DX-100 is a General Coverage Communications Receiver designed and manufactured to the most rigid quality standards. It has been packed to ensure safe arrival. Carefully lift the unit out of the shipping carton and inspect for any visible damage.

Decide where you want to set up the Receiver. In making your decision you should consider:

1. **YOUR COMFORT.** You will spend many hours with your Receiver; be sure it is placed where you can enjoy it at any time.
2. **YOUR ANTENNA.** For immediate operation you can use the telescopic antenna provided. However, to realize the maximum performance, you will need a long wire shortwave antenna (such as Radio Shack's 278-758).
3. **YOUR GROUND.** If you set up an outside antenna, for safety you should connect a ground wire to the Receiver. This will require running a ground wire from the ground screw connection on the back of the Receiver to a metal cold water pipe or metal pipe driven into the earth.

ANTENNAS

A suitable antenna is vital to get maximum performance from your DX-100. We've provided two antennas with your Receiver. One is a simple back-of-the-set telescopic antenna which is handy for portable use. You'll find that this antenna can often do a good job, particularly when receiving more powerful stations.

There's also a built-in ferrite loopstick for AM band.

But for the very best reception you'll need an outdoor antenna. Unfortunately, there is no single antenna which will give top performance throughout the 520 kHz – 30 MHz range of your DX-100. One type of antenna which is a good compromise choice for most listening is the longwire. As the name implies, the longwire is a long length of wire (usually 50 to 100 feet) mounted as high as possible. Your local Radio Shack has a shortwave antenna kit (278-758) which contains everything you need to erect a longwire antenna. You can also purchase the needed items individually at your Radio Shack store if you desire.

The longwire is erected as shown in the diagram below. Be especially careful to avoid running any portion of the antenna or lead in wire over or under electric lines. The static discharge unit is important to help prevent damage to your Receiver from close (not direct) lightning strikes. Your Radio Shack store also has these available.

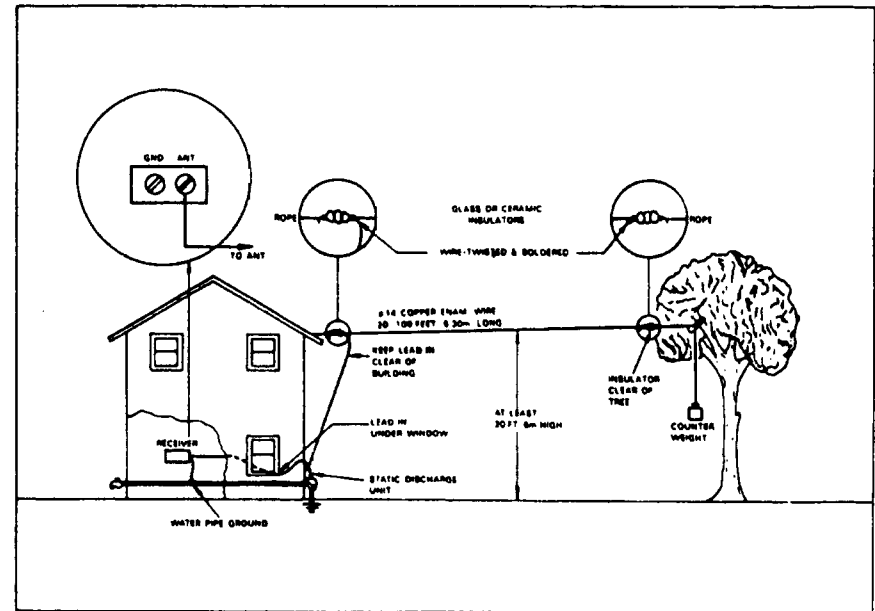

GROUNDING

To insure best reception, you must always connect a Ground wire to the GND screw on the back of the Receiver. Use a heavy gauge wire for this. Connect the other end either to a metal cold water pipe (not hot water and not natural gas pipe) or to a metal rod driven into the ground. Or, you can bury a copper plate or copper screen in the ground and make connection to it.

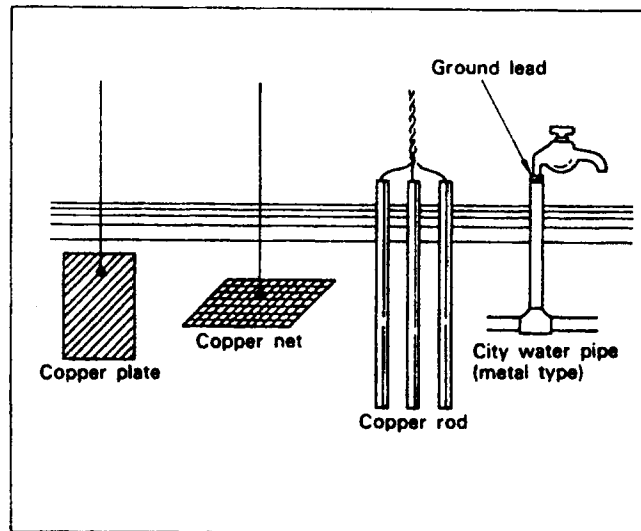

OPERATION

Before operating your DX-100 you should have an antenna and ground connected. And, of course, you must either have the power cord connected to a standard AC outlet or connect the DC power cord to a source of 12 volts DC.

Since you probably are most familiar with the standard broadcast band radio reception, you might prefer to use the DX-100 there first.

1. Turn power "on" by rotating VOLUME in a clockwise direction.
2. Set the BAND Switch to position A (520 – 1620 kHz).
3. Adjust Main Tuning and FINE Tuning for the desired station. (Adjust for maximum reading on the SIGNAL STRENGTH Meter.)
4. Set VOLUME for desired level.

For private listening, plug in headphones (requires $\frac{1}{4}$ " 6.35 mm plug).

Tuning Frequencies Above 1.55 MHz

The rest of the bands are quite easy to tune.

1. Set BAND Switch to the appropriate position.
2. Adjust Main Tuning and FINE Tuning for the desired station. Set VOLUME as required.
3. If you are tuning for SSB (single sideband) or CW (continuous wave, or "code" as the more common term is), set Mode Switch to SSB/CW. Adjust BFO Pitch to precisely tune in the signal.
4. Often for optimum sensitivity you'll find that it helps to make a slight readjustment of FINE Tuning.
5. If you are in the AM mode and noise is excessive, set MODE Switch to AM ANL position.

SPECIAL OPERATING NOTES

Your DX-100 is a fine example of modern design in the field of shortwave equipment. It is simple to operate, and yet has the most-wanted features and controls — plus the fact that it is a continuous-coverage receiver (tunes ALL frequencies from 520 kHz to 30 MHz). Short Wave Listening is a great hobby — your skill will grow with experience and of course experience only comes with practice. This section has a number of hints relating to the proper use of your Receiver. We can't possibly turn you into an expert SWL just by giving you thorough instructions — but these hints will help.

Proper use of the FINE Tuning control on your DX-100 is important for best reception. Always check the SIGNAL STRENGTH Meter when using FINE Tuning; adjust for highest reading on the Meter. If you listen to the same station for a long period of time you may find it helpful to slightly re-adjust FINE Tuning every half hour or so. This will keep your DX-100 precisely tuned to the desired frequency. Carefully note the dial position of both FINE Tuning and Main Tuning when tuning various stations — this will let you quickly retune to your favorite ones.

The MODE Switch determines the type of signal that your Receiver recovers. For standard broadcast and international shortwave signals, use the AM position. For code or SSB signals, use SSB/CW position. If pulse-type noise interferes with reception of AM signals, use the AM ANL position. You may notice that with the AM ANL position (Automatic Noise Limiter), the signal reception seems to drop slightly; this is normal (thus it is best not to use the ANL mode unless noise is a serious problem).

When tuning SSB and code signals, adjust the FINE Tuning control very slowly. In the Ham bands, much of the activity is in code or SSB. If you tune through an SSB signal and you are in the AM mode, there will only be a fluttering sound (you'll be able to tell that a signal is there, but won't be able to understand anything). Use the SSB mode and slowly adjust FINE Tuning and/or BFO Pitch until the voice sounds are normal. When improperly tuned, voices will have a low guttural sound or will sound like "Donald Duck". Tuning of SSB signals takes a little patience and practice.

If you tune through AM signals while using the SSB/CW mode, you will have a very annoying background tone, which varies with the setting of the Tuning controls. In this happens, set MODE to AM.

As you have notices, there are two Models for SSB signals — LSB and USB (Lower Side Band and Upper Side Band).

The following chart shows you the normal SSB mode of operation for the Ham bands:

METERS	FREQUENCY	SIDEBAND USED
80	3.5 to 4.0 MHz	Lower
40	7.0 to 7.3 MHz	Lower
20	14.0 to 14.35 MHz	Upper
15	21.0 to 21.45 MHz	Upper
10	28.0 to 29.7 MHz	Upper

For LSB, adjust BFO toward (-). For USB, adjust toward (+).

The STD BY (Standby) mode is always incorporated in high quality communications and Ham-type Receivers. Using this mode, you leave all the main circuits "on", but disable the audio portion. Thus, you can leave the Receiver on (to maintain maximum frequency stability) and yet are not disturbed by the audio.

A pair of headphones is a great asset for serious SWLing. They make it much easier to hear and understand some of those weak and distant stations. We strongly suggest you consider purchasing a pair of communications headphones — 8 ohm impedance type. Your Radio Shack store has some good choices.

You can use 12 volts DC to power your Receiver. For example, if you want to mount the Receiver in a vehicle, or take it on a field trip, a source of 12 volts DC will operate it. Connect the 12 volt DC power to the connector on the rear using the DC cord. It can be connected to either positive or negative ground systems.

Be sure you connect the external power leads with the correct polarity: + to + and - to -.

CHANGES IN RECEPTION

You'll soon notice that reception on the different bands covered by your DX-100 varies with the time of day and season of the year. Certain areas of the world can be better received at certain times of the day than at others. All this may seem confusing at first, but these changes in reception do follow a clear pattern which you can use in planning your listening time.

Generally speaking, the 1.55 to 10 MHz range will give best reception from the late afternoon (approximately two hours before your local sunset) until shortly after dawn at your listening location. In the late afternoon and evening hours you'll find stations to the east of your location coming in well. But as the night wears on, these stations will fade out and be replaced by stations to the west of your location. For example, listeners in Canada will find stations in Europe and Africa best received on 49 meters (5950 ~ 6200 kHz) during the late afternoon and early evening. Later in the night, stations from the Pacific Ocean area will fade in, followed soon by stations in Asia and Australia. Stations in Latin America can be received most of the night since that area is in darkness approximately the same time as North America.

The 11 to 15 MHz range is a transition area, with signals often found here at all hours, although they may not be as strong as those on other bands.

From 15 to 30 MHz is primarily a daytime range, with often no signals audible during the night. In the morning hours and early afternoon signals will be heard from east of your location. During late afternoons and early evening listen for stations west of you.

Reception also varies with the season of the year. Signals in the 1.55 to 10 MHz range are often stronger in the winter; while during the summer months stations can be heard in the 15 to 30 MHz range well into the night.

BAND ALLOCATION

To avoid interference and confusion, certain portions of the radio spectrum have been set aside for specific purposes. Perhaps the most familiar example is 540 – 1600 kHz, which is the "standard" AM broadcast band.

Ham radio operators have use of the following bands:

160 meters = 1.8 – 2.0 MHz
80 meters = 3.5 – 4.0 MHz
40 meters = 7.0 – 7.30 MHz
20 meters = 14 – 14.35 MHz
15 meters = 21 – 21.45 MHz
10 meters = 28 – 29.7 MHz

International broadcasting stations have several bands set aside for them:

49 meters = 5.95 – 6.2 MHz
41 meters = 7.1 – 7.3 MHz
31 meters = 9.5 – 9.775 MHz
25 meters = 11.7 – 15.45 MHz
19 meters = 15.1 – 15.45 MHz
16 meters = 17.7 – 17.9 MHz
13 meters = 21.45 – 21.75 MHz
11 meters = 25.6 – 26.1 MHz

Note that broadcasters and hams share 7.1 – 7.3 MHz, and interference is heavy in that range.

Broadcasters in tropical regions have special bands set aside for them. In such areas shortwave is the only way to reach isolated locations:

120 meters = 2.3 – 2.498 MHz
90 meters = 3.2 – 3.4 MHz
60 meters = 4.75 – 5.06 MHz

The rest of the shortwave range is filled with marine, aeronautica and military stations. Such stations usually use either SSB or CW, and can be found outside the amateur and broadcast bands.

FREQUENCY CONVERSION

Your Communications Receiver is calibrated in Megahertz (MHz)—as most communications-type receivers are. However two other terms are used quite often—you should know what they are and how to convert from each one to the others.

First, **Megahertz**. This stands for millions-of-Hertz (or cycles-per-second as we used to call Hertz). A Megahertz is 1,000,000 Hertz (Hz for short) or 1,000,000 cycles-per-second. Mega means million.

Second, **Kilohertz**. This stands for thousands-of-Hertz. A Kilohertz is 1,000 Hertz. We use the abbreviation kHz; thus, 1 kHz. Kilo means thousand.

Third, **Meter**. The term Meter, as applied to Short Wave Listening, refers to the wavelength of a radio frequency. In many parts of the world, frequencies are listed in Meters; for example, International Short Wave Stations in the 19 Meter band. European radio equipment and stations often refer to the wavelength of a station or band (in meters), rather than the frequency (in MHz or kHz).

The relationship of these three terms is:

$$1 \text{ MHz (million)} = 1000 \text{ kHz (thousand)}$$

Thus, to change 9.62 MHz to kHz, we multiply by 1000.

$$9.62 \text{ MHz} \times 1000 = 9620 \text{ kHz}$$

To go the other way, from kHz to MHz, divide by 1000. Thus, a station at 3780 kHz is

$$\frac{3780 \text{ kHz}}{1000} = 3.780 \text{ MHz}$$

To convert MHz to meters, use this formula:

$$\text{Meters} = \frac{300}{\text{MHz}}$$

Example: What is the wavelength of 7.1 MHz?

$$\frac{300}{7.1 \text{ MHz}} = 42.25 \text{ meters}$$

To convert meters to MHz, use this formula:

$$\text{MHz} = \frac{300}{\text{meters}}$$

Example: What is the frequency of a station on a wavelength of 19.5 meters?

$$\frac{300}{19.5 \text{ meters}} = 15.385 \text{ MHz}$$

TIME CONVERSION

A 24-hour clock is used to tell communications time. One AM is 0100; four AM is 0400; Noon is 1200; 3:30 PM is 1530; 8:45 PM is 2045. This simple method precludes any confusion between AM and PM. (See Chart).

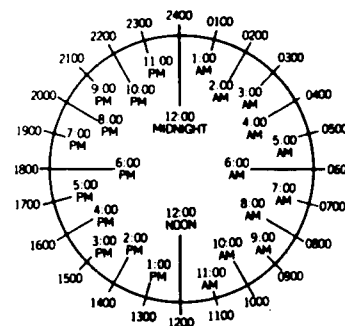

GMT (Greenwich Mean Time—the time at Greenwich Observatory, England) is the basis for telling the time in International Broadcasting. To convert from GMT to local time in International Broadcasting, add or subtract the hours shown on the INTERNATIONAL TIME MAP (below).

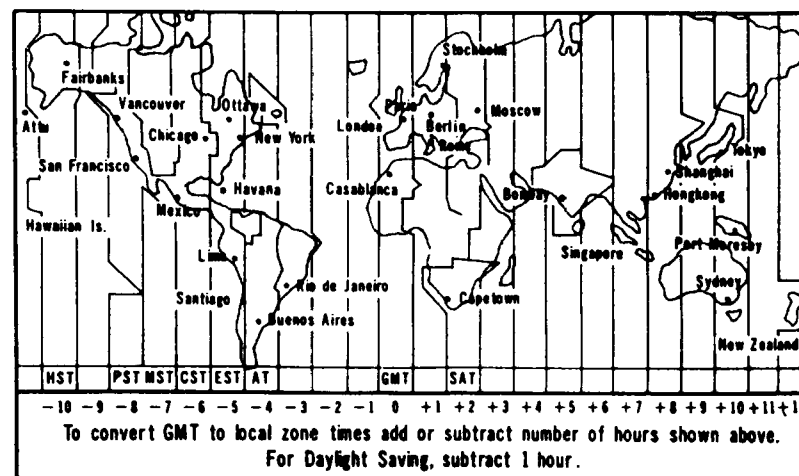

Example: 2300 GMT is 1800 EST (Eastern Standard Time). This is equivalent to 11:00 PM in London, Eng., 6:00 PM in New York or 8:00 AM in Tokyo (the next day).

SHORT WAVE LISTENING

Shortwave listening (SWLing) is a hobby with thousands of participants worldwide. While no special knowledge is required for SWLing, you will find your enjoyment increases with experience and special techniques for listening.

Random tuning on your DX-100 is a good idea if you're never owned a Communications Receiver before. In this way you can get acquainted with the various bands and the stations which can be heard. But after you've been listening for a while you'll discover that you can get more enjoyment by organizing your listening efforts.

Your local Radio Shack has a book entitled *Shortwave Listener's Guide* (62 - 2032). It lists stations around the world along with their frequency, call letters, and hours of operation. You'll find a copy of this book valuable when you want to hear a specific station - it will save you hours of searching the airwaves at random to find the station you want to hear.

You will also find it valuable to keep a Log Book of what you hear. This will allow you to discover patterns of station activity (hours and days of operation, etc.) and enable you to keep track of what you've heard. Many listeners enjoy trying to hear as many different stations and countries as possible. A Log Book will also be an interesting diary of your listening experiences. Your local Radio Shack has a convenient Log Book (62 - 2034).

Doing a little bit of library research can increase your skill as a SWL. Read up on radio propagation and theory; try to understand the conditions which make long distance reception possible. In your local library you can find such valuable references as the *World Radio Television Handbook* and the *Radio Amateur's Handbook*. Current information can be found by consulting periodicals dealing with communications and electronics.

Keep up to date on news events around the world. There's much interesting listening just tuning to the international service of a nation where an important event is taking place.

Ham radio operators can be found in the bands listed in our Band Allocations section. You'll find that hams mainly use Morse code (or CW, as they refer to it) and SSB. The ham bands are divided up into CW and SSB sections in the following manner:

3.5 - 3.8	MHz: CW
3.8 - 4.0	MHz: SSB
7.0 - 7.15	MHz: CW
7.15 - 7.3	MHz: SSB
14.0 - 14.2	MHz: CW
14.2 - 14.35	MHz: SSB
21.0 - 21.25	MHz: CW
21.25 - 21.45	MHz: SSB
28.0 - 28.5	MHz: CW
28.5 - 29.7	MHz: SSB

These boundaries are not precisely observed everywhere in the world, so don't be too surprised to find a SSB signal in the CW portion of a band and vice-versa.

Aircraft flying international routes use shortwave for their communications. Most transmissions are in SSB, although some AM is still heard. Some of the ranges where aircraft can be heard include:

4.65 - 4.75	MHz	11.175 - 11.4	MHz
6.525 - 6.765	MHz	13.2 - 13.36	MHz
8.815 - 9.040	MHz	15.01 - 15.1	MHz
10.005 - 10.100	MHz	17.9 - 18.03	MHz

NOTES ON OPERATING ON EACH BAND

This section will give you some specific ideas of what to look for on each band. It can be a helpful guide while operating the Receiver.

BAND A—535 to 1.6 MHz (535 to 1600 kHz) is the standard AM broadcast band. In most countries around the world these frequencies are very active with local radio stations. You are most familiar with this band, so we don't need to tell you much about it.

BAND B—1.55 to 4.5 MHz. There are many varied signals within this band. From 1.55 to 2 MHz you will hear many broadcast stations and if you are near the ocean or large bodies of water, you will pick up maritime signals (ship, ship-to-shore and navigational signals). In some areas you will pick up Ham Operators between 1.8 and 2.0 MHz; they are limited in power and to certain geographical areas, so you won't always be able to hear them.

Between 2 and 3 MHz, you should pick up some governmental services, marine and aircraft signals. Near 2.2 there is a distress calling channel. This band also includes the 120 meter International Short Wave band (see **Band Spread and Dial Calibration**).

At 2.5 MHz, the National Bureau of Standards transmits very precise time signals and gives periodic propagation reports. Many countries around the world have special time standard broadcasting signals at various other frequencies (both on this band and others)—for example, 3.33 MHz is a Canadian station, CHU; Australia has one at 4.5; Chile has one at 4.298; many European countries use 2.5.

The 90 and 75 meter International Short Wave bands are also here, plus the 80 meter Ham Band. Hams are fun to listen to—set the **MAIN TUNING** to calibrate the Band Spread Dial for 80 meters and try it. You'll hear code signals from 3.5 to 3.8 and voice from 3.8 to 4.0.

BAND C—4.5 to 13 MHz. This and Band D are the best ones for Short Wave Listening. Certain times of the year and day, these bands are just full of signals.

The technique of DX chasing (looking for distant station signals) requires a certain degree of electronic detective work. Although some activity always prevails on the bands, you will find your time more enjoyably employed if you spend time preparing before chasing DX. Check WWV stations for propagation reports, do some reading research, keep an up-to-date SWL Log Book and then review it regularly.

Later on, we have given you a brief list of International Short Wave Stations in the form of a **Country Log**. Look it over, follow it and use it.

The 59 and 60 meter bands (4.75-4.85 and 5.005-5.06 MHz) provide domestic broadcast signals for much of the world. However, you will be able to pick up many of these signals from wherever you are. This has been referred to as the **Tropical Band** since many of the stations are located in Central and South America. Sometimes, North American SWLers also pick up Africa too. Best reception is the winter months and in the early evenings.

The 49 meter band (5.95-6.2 MHz) has some very popular and strong International Broadcast stations and reception should normally be quite good.

The 41 meter band (7.1-7.3 MHz) is shared with two or three services, so you may run into interference between these services. Ham radio stations (40 meter Ham Band) and strong International Short Wave stations will be very prominent here.

Notes on Operating on Each Band—continued

The 31 and 25 meter bands (9.5-9.75 and 11.7-11.975 MHz) are very good bands for both day and night reception.

You can pick up time standard signals at 5.0, 10 and 7.335 MHz. The first two are WWV and the last is CHU. If you can't get one, try another.

BAND D—13 to 30 MHz offers more fine listening. WWV has time standard signals at 15, 20 and 25 MHz; CHU has one at 14.67 MHz. There are 4 Short Wave bands here, plus 3 Ham bands and the CB frequencies. The sun spot cycle greatly effects DX reception within this band. The peak of the present cycle passed about in 1968 and the minimum is expected about 1976; the greater the sun spot activity, the better the reception at these higher frequencies. So, don't be surprised if reception is not as good as some of the lower bands.

The 19 meter International Short Wave Band (15.1-15.45 MHz) provides excellent daytime listening. Some night listening may be noted during the summer.

The 16 meter International Short Wave Band (17.7-17.9 MHz). During periods of sun spot activity, some really astounding DX reception is possible—especially during the day.

The 13 and 11 meter Short Wave Bands (21.45-21.75 and 25.6-26.1 MHz) are similar in reception conditions to the 16 and 19 meter bands. Reception may be superior with sun spot activity.

The Ham bands are very active. 20 meters (14.0-14.35 MHz) is always busy. You will hear code from 14 to 14.2 and voice above that. DX will be most prominent near dusk and dawn. 15 and 10 meters (21.0-21.45 and 28-29.7 MHz) at times will be very active; other times they will be "dead".

There is always activity on the Citizens' Band (11 meters, channels 1 through 23 on the Band Spread Dial), especially in areas near large cities.

MORSE CODE AND RADIO TERMS

Familiar Short Wave and Amateur Radio Terms

AF Gain Control—same as volume control
AM (Amplitude Modulation)—the amplitude of the transmitting signal is varied at an audio rate
ANL (Automatic Noise Limiter)—reduces impulse noises (ignition, static, crashes, etc.)
ANT—Antenna
AVC (Automatic Volume Control)—controls the gain of the radio frequency amplifying circuits automatically (i.e. reduces gain on strong signals)
BFO (Beat Frequency Oscillator)—provides a special internal signal so that CW (code) signals can be heard
CQ—a general call used by radio amateurs to establish contact. Caller will talk to anyone who answers. Can also be used specifically (CQ/DX, when calling only DX stations, or CQ Chicago, when calling stations only in Chicago)
CW (Continuous Wave)—unmodulated signal wherein intelligence is transmitted by interrupting signal to produce dots and dashes (code)
DX—distant stations
FM (Frequency Modulation)—the transmitting frequency is varied at an audio rate
QRM—interference from other signals
QRN—interference static
QRX—Stand-by
QSL—usually a card which verifies contact or acknowledges specific transmission
QSO—a contact between two stations
QSY—change operating frequency
RF Gain Control—radio frequency gain control: controls the sensitivity of the radio frequency amplifier stage
RST—readability, strength, tone (refers to a system of rating the quality of reception of code signals)
SWL—short wave listener
73's—best regard
88's—love and kisses
XYL—wife
YL—young lady
SSB—Single Side Band.

Associated Public Safety Communications Officers, Inc. Official Ten-Signals List (Police, Fire, etc.)

10-0	Caution	10-3	Stop transmitting
10-1	Unable copy—change location	10-4	Acknowledgment (OK)
10-2	Signal good	10-5	Relay
		10-6	Busy—unless urgent

REPORTING AND QSLs

You'll soon notice that many of the international broadcasting stations will ask for "reception reports" from listeners and offer to send "QSL cards" in return. Since "QSLing" is a major goal of many SWLs, let's discuss what's involved.

International broadcasters like to get letters from listeners telling how well their signals are being received. To encourage listeners to write more often, stations reply to listener reception reports with cards or letters confirming that the SWL indeed heard the station. Numerous SWLs eagerly collect these confirming cards or letters, known as QSLs, and some have managed to get QSLs from stations in over 200 different countries. Major international broadcasters frequently change the designs of their QSL cards, and many SWLs like to collect entire sets of QSLs from a single station.

What goes into a good reception report? Tell the station the frequency you heard them on, the time (use GMT from our Time Conversion chart), and the date on which you received them. Include some details about the program you heard (announcer names, program titles, musical selections, etc) so that the station will know you really heard them. Describe the strength and readability of their signals, making careful note of any interfering stations. Tell them that you use a Realistic DX-100 and also describe your antenna system. You might also want to include comments on the type of programs you want to hear in the future, as well as some remarks on the broadcast you are reporting on. Finally, request that if your report is correct that the station send you a QSL card or letter.

If the broadcast you heard was in English, you can send your report in that language as well. Usually the station will give its address during the program, but for most larger stations you can simply send your report to the station's studio location (such as Israel Radio Jerusalem, Israel). One pleasant benefit of reporting is that many stations will put you on their mailing list to receive program schedules and special mailings of interest to listeners. Some stations even send out special gifts and souvenirs to regular reporters.

FREQUENCY CONVERSION

Your Communications Receiver is calibrated in Megahertz (MHz)—as most communications-type receivers are. However two other terms are used quite often—you should know what they are and how to convert from each one to the others.

First, **Megahertz**. This stands for millions-of-Hertz (or cycles-per-second as we used to call Hertz). A Megahertz is 1,000,000 Hertz (Hz for short) or 1,000,000 cycles-per-second. Mega means million.

Second, **Kilohertz**. This stands for thousands-of-Hertz. A Kilohertz is 1,000 Hertz. We use the abbreviation kHz; thus, 1 kHz. Kilo means thousand.

Third, **Meter**. The term Meter, as applied to Short Wave Listening, refers to the wavelength of a radio frequency. In many parts of the world, frequencies are listed in Meters; for example, International Short Wave Stations in the 19 Meter band. European radio equipment and stations often refer to the wavelength of a station or band (in meters), rather than the frequency (in MHz or kHz).

The relationship of these three terms is:

$$1 \text{ MHz (million)} = 1000 \text{ kHz (thousand)}$$

Thus, to change 9.62 MHz to kHz, we multiply by 1000.

$$9.62 \text{ MHz} \times 1000 = 9620 \text{ kHz}$$

To go the other way, from kHz to MHz, divide by 1000. Thus, a station at 3780 kHz is

$$\frac{3780 \text{ kHz}}{1000} = 3.780 \text{ MHz}$$

To convert MHz to meters, use this formula:

$$\text{Meters} = \frac{300}{\text{MHz}}$$

Example: What is the wavelength of 7.1 MHz?

$$\frac{300}{7.1 \text{ MHz}} = 42.25 \text{ meters}$$

To convert meters to MHz, use this formula:

$$\text{MHz} = \frac{300}{\text{meters}}$$

Example: What is the frequency of a station on a wavelength of 19.5 meters?

$$\frac{300}{19.5 \text{ meters}} = 15.385 \text{ MHz}$$

TIME CONVERSION

A 24-hour clock is used to tell communications time. One AM is 0100; four AM is 0400; Noon is 1200; 3:30 PM is 1530; 8:45 PM is 2045. This simple method precludes any confusion between AM and PM. (See Chart).

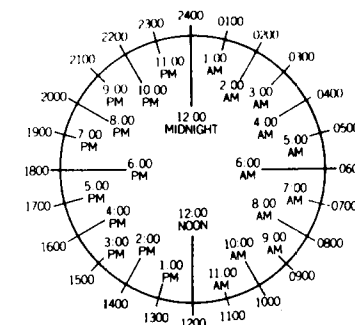

GMT (Greenwich Mean Time—the time at Greenwich Observatory, England) is the basis for telling time in International Broadcasting. To convert from GMT to local time or any other time zone, add or subtract the hours shown on the INTERNATIONAL TIME MAP (below).

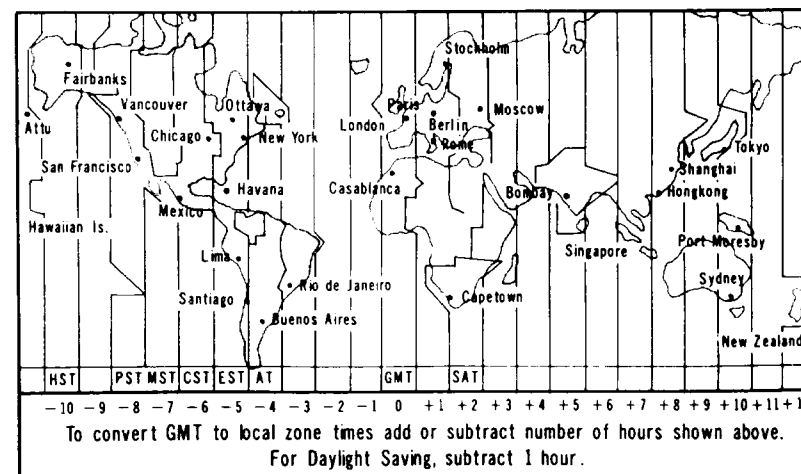

Example: 2300 GMT is 1800 EST (Eastern Standard Time). This is equivalent to 11:00 PM in London, Eng., 6:00 PM in New York or 8:00 AM in Tokyo (the next day).

- | | | | |
|-------|----------------------|-------|----------------------------|
| 10-7 | Out of service | 10-35 | Major crime alert |
| 10-8 | In service | 10-36 | Correct time |
| 10-9 | Repeat | 10-39 | Urgent—use light, siren |
| 10-10 | Fight in progress | 10-40 | Silent run—no light, siren |
| 10-12 | Stand by (stop) | 10-50 | Accident (F, PI, PD) |
| 10-13 | Weather—road report | 10-51 | Wrecker needed |
| 10-14 | Prowler report | 10-52 | Ambulance needed |
| 10-15 | Civil disturbance | 10-53 | Road blocked at _____ |
| 10-18 | Quickly | 10-57 | Hit and run (F, PI, PD) |
| 10-19 | Return to— | 10-70 | Fire alarm |
| 10-20 | Location | 10-78 | Need assistance |
| 10-24 | Assignment completed | 10-80 | Chase in progress |
| 10-31 | Crime in progress | 10-89 | Bomb threat |
| 10-32 | Man with gun | 10-90 | Bank alarm at _____ |
| 10-33 | EMERGENCY | 10-98 | Prison/jail break |
| 10-34 | Riot | 10-99 | Wanted/stolen indicated |

NOTE: CBers use 10-Code signals similar to this one, but in some cases, the meanings are quite different. For information, refer to **RADIO SHACK'S LOG BOOK**.

COUNTRY LOG

The following listing will be useful in spotting and identifying International Short Wave Broadcasting stations in operation around the world. The stations listed can be heard throughout the North American Continent. Transmission periods vary throughout day and night. All broadcasts (unless otherwise specified) are in English.

Columns are provided for **LOCAL TIME HEARD** (see **TIME CONVERSION**) and **PROGRAM TYPE** so that you may identify the broadcast you heard. You might want to note the Logging scale number too.

For a more complete or/and up-to-date list, check monthly periodicals on Short Wave Listening. There are many, many more stations and frequencies in constant use by all nations around the world—far more than we can list here.

INTERNATIONAL MORSE CODE

Letter Phonetic Sound	Dot-Dash Sequence	Letter Phonetic Sound	Dot-Dash Sequence
A	di-dah	T	dah
B	dah-di-di-dit	U	di-di-dah
C	dah-di-dah-dit	V	di-di-di-dah
D	dah-di-dit	W	di-dah-dah
E	dit	X	dah-di-di-dah
F	di-di-dah-dit	Y	dah-di-dah-dah
G	dah-dah-dit	Z	dah-dah-di-dit
H	di-di-di-dit		
I	di-dit		
J	di-dah-dah-dah	Numbers	
K	dah-di-dah	1	di-dah-dah-dah-dah
L	di-dah-di-dit	2	di-di-dah-dah-dah
M	dah-dah	3	di-di-di-dah-dah
N	dah-dit	4	di-di-di-di-dah
O	dah-dah-dah	5	di-di-di-di-dit
P	di-dah-dah-dit	6	dah-di-di-di-dit
Q	dah-dah-di-dah	7	dah-dah-di-di-dit
R	di-dah-dit	8	dah-dah-dah-di-dit
S	di-di-dit	9	dah-dah-dah-dah-dit
		0	dah-dah-dah-dah-dah

CITY	COUNTRY	CALL	MHz	PROGRAM TIME HEARD
Monrovia	Liberia	ELBC	3.255	
Belize	British Honduras		3.300	
Accra	Ghana		3.366	
Paradys	S. Africa		4.810	
	Singapore	FBS	5.010	
Dar-es-Salaam	Tanzania		5.050	
Addis-Ababa	Ethiopia		5.060	
Sao Paulo	Brazil	ZTR226	5.955	
Ismaning	Germany		5.960	
Ciudad	Dominican Republic	Radio Caribe	5.970	
Jesselton	North Borneo		5.980	
Cap Haitien	Haiti	4VB	5.980	
Bucharest	Rumania		5.990	
Brussels	Belgium	ORU	6.000	
Abu Zabad	Egypt		6.015	
Salisbury	Rhodesia		6.020	
Tangier	Morocco		6.025	
Abu Ghurais	Iraq		6.030	
Daventry	England	GWS	6.035	
	Monaco	3M3	6.037	
Nanking	China	BCA22	6.040	
Djakarta	Indonesia	YDF	6.045	
Ibadan	Nigeria		6.050	
Warsaw	Poland		6.055	

CITY	COUNTRY	CALL	MHz	PROGRAM	TIME HEARD	CITY	COUNTRY	CALL	MHz	PROGRAM	TIME HEARD
Seckville N.B.	Canada	CKR2	6.060			Melbourne	Australia	VLA	11.710		
Delhi	India		6.065			Hilversum	Holland		11.730		
Minsk	U.S.S.R.		6.075			St. George's	Windward Islands		11.735		
Halifax	Canada		6.100			Rabat	Morocco		11.735		
London	England	BBC	6.110			Vatican City	Vatican	HVJ	11.740		
	Monaco					Montreal	Canada	CBC	11.760		
Tokyo	Japan	FEN	6.160			Djakarta	Indonesia		11.795		
Mexico City	Mexico		6.165			Melbourne	Australia	VLA	11.810		
Berne	Switzerland		6.165			Moscow	U.S.S.R.	Radio Moscow	11.813		
Kaduna	Nigeria		6.175			Brussels	Belgium	ORU	11.850		
Pyongyang	North Korea		6.195			Elizabethville	Katanga		11.866		
Pyongyang	North Korea		6.250			Manila	Philippines	DZF2	11.920		
Cairo	Egypt		7.051			Brazzaville	Congo		11.925		
Chiavi	Taiwan		7.100				Singapore	BBC-FES	11.955		
Brazzaville	Congo		7.105			Peking	China		12.125		
Naha	Okinawa	VOA	7.160			Teheran	Iran	2PB	15.125		
Budapest	Hungary		7.220			Tokyo	Japan	JOA15	15.135		
Karachi	Pakistan		7.280			Helsinki	Finland	O1X4	15.190		
Berlin	East Germany		7.300			Montreal	Canada		15.190		
Prague	Czechoslovakia		7.340			Monrovia	Liberia	ELWA	15.198		
Moscow	U.S.S.R.	Radio Moscow	7.555			Taipei	Taiwan	BED3	15.225		
Brussels	Belgium		9.144			Belgrade	Yugoslavia		15.240		
Sofia	Bulgaria		9.255			Stockholm	Sweden	Radio Sweden	15.240		
Peking	China		9.480			Tel Aviv	Israel		15.250		
Copenhagen	Denmark	OZF	9.520			Colombo	Ceylon		15.265		
Havana	Cuba		9.531			Warsaw	Poland		15.275		
Lagos	Nigeria		9.535			Wellington	New Zealand	ZLA	15.280		
Berne	Switzerland		9.535			Melbourne	Australia	VLA	15.315		
Wellington	New Zealand	ZL2	9.540			Paris	France		15.350		
Prague	Czechoslovakia		9.550			New York City	U.S.A.	WRUL	15.380		
St. George's	Windward Islands	WIBS	9.550			Cologne	West Germany	DMQ15	15.405		
Bucharest	Rumania		9.570			Seoul	South Korea	HJK9	17.745		
Roma	Italy	RAI	9.575			New York City	U.S.A.	WRUL	17.750		
Montreal	Canada	CBC	9.585			Lisbon	Portugal	CSA44	17.870		
Lourenco Marques	Mozambique	CR7BI	9.616								
Stockholm	Sweden	Radio Sweden	9.665								
Buenos Aires	Argentina	LRA	9.690								
Cuidad Republic	Dominican Republic	Radio Caribe	9.735								
Peking	China		9.785								
Moscow	U.S.S.R.	Radio Moscow	9.805								
Barbados	Windward Island	2NX50	11.475								
Moscow	U.S.S.R.	Radio Moscow	11.570								
Cairo	Egypt		11.665								
Bangkok	Thailand	HSK9	11.670								
Karachi	Pakistan	11.674									
Stockholm	Sweden	Radio Sweden	11.705								
New Delhi	India		11.710								

Specifications

Frequency Coverage:

A	520 – 1620 kHz
B	1.55 – 4.5 MHz
C	4.5 – 13 MHz
D	13 – 30 MHz

IF Frequency

All Bands 455 kHz

BFO Pitch range

± 5 kHz (at 7 MHz)

Antennas

Bands A/B/C ferrite rod
built-in, plus Telescopic
antenna for Bands B/C/D

Power Output (8 ohm)

750 milliwatts (10% THD)

Power Requirements

120 volts, 60 Hz, 6 watts
max. (240 volts, 50 Hz
for Australian models) or
external 12 volts negative/
positive Ground, 4 watts
max.

Dimensions

4-3/4 x 11-13/16 x 9-7/8" HWD
120 x 300 x 251 mm

Weight

4 lbs. 7 oz. 2 kg

SCHEMATIC DIAGRAM

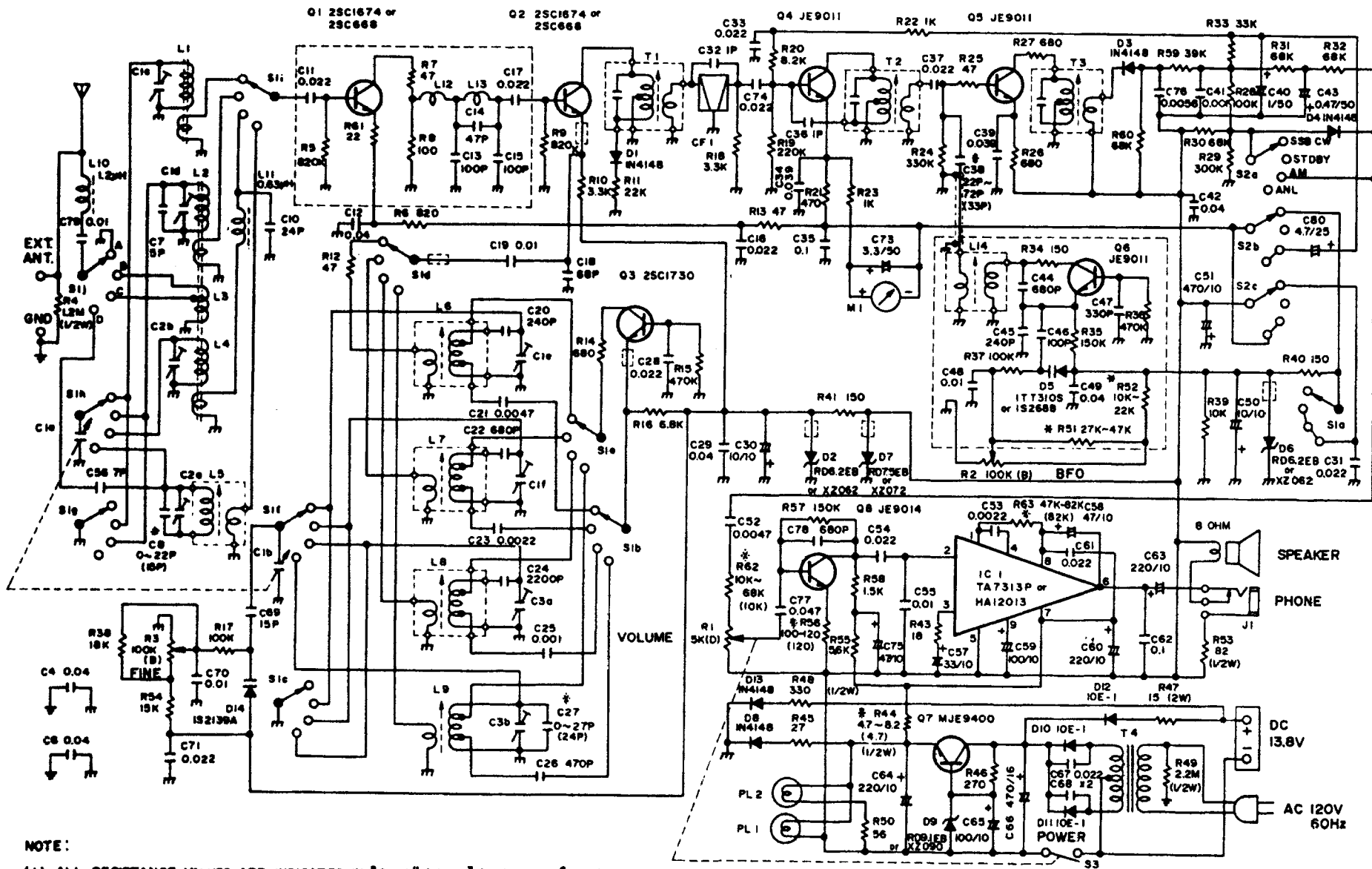

NOTE:

- (1) ALL RESISTANCE VALUES ARE INDICATED IN "OHM" (K=10³ OHM, M=10⁶ OHM)
- (2) ALL CAPACITANCE VALUES ARE INDICATED IN "μF" (P=10⁻⁶ μF)
- (3) * MAY VARY FROM UNIT TO UNIT FOR BEST PERFORMANCE.
- (4) * WHEN D5 IS USED AS 1T7310S, THE VALUE OF R51 MUST BE 47K OHM AND R52 MUST BE 22K OHM.
WHEN D5 IS USED AS IS2688, THE VALUE OF R51 MUST BE 27K OHM AND R52 MUST BE 10K OHM.

RADIO SHACK  A TANDY CORPORATION COMPANY
FORT WORTH, TEXAS 76107

8A4-Y8000

PRINTED IN JAPAN