

PRO-2025

16-Channel Direct Entry Programmable Scanner

OWNER'S MANUAL

Please read before using this equipment

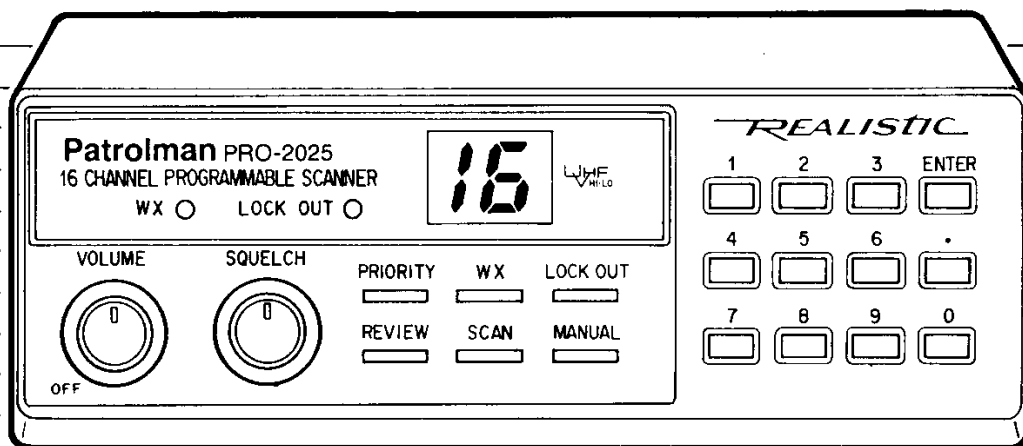

Cat. No. 20-146

REALISTIC[®]

INTRODUCTION

Your new Realistic PRO-2025 16-Channel Direct Entry Programmable Scanner lets you in on all the action! This scanner gives you direct access to over 20,000 exciting frequencies that include the police department, fire department, ambulance, amateur radio, and transportation services. You can select up to 16 channels for your scanner to scan and you can change your selection at any time.

The secret to your scanner's ability to scan so many frequencies is its custom-designed microprocessor — a tiny, built-in computer. Your scanner's microprocessor also gives your scanner these special features:

Digital Channel Display — makes the channel number easy to read.

Automatic Two-Second Scan Delay — helps to prevent the loss of replies on a channel while you are scanning.

Memory Backup — keeps the channel frequencies stored in your scanner's memory for up to sixty days, even if the power switch is in the off position.

Lock-Out Function — lets your scanner skip over specified channels.

Priority Channel — helps keep you from missing important calls on Channel 1.

Weather Band Key — lets your scanner scan the preprogrammed weather frequencies to keep you informed of the most current weather conditions.

Your scanner covers all of these bands:

- 29-29.7 MHz (ham radio 10 m)
- 29.7-50 MHz (VHF Lo)
- 50-54 MHz (ham radio 6 m)
- 136-144 MHz (government)
- 144-148 MHz (ham radio 2 m)
- 148-174 MHz (VHF Hi)
- 406-450 MHz (ham radio and government)
- 450-470 MHz (UHF Lo)
- 470-512 MHz (UHF Hi)

Note: Mobile use of scanners might be unlawful or require a special permit in certain areas. Check with your local authorities for current regulations. Radio Shack assumes no responsibility for the use of this scanner in such areas.

For your permanent records, we urge you to record the serial number of your scanner in the space provided below. You will find the serial number on the back panel of the scanner.

Serial Number: _____

© 1990 Tandy Corporation.
All Rights Reserved.

Realistic and Radio Shack are registered trademarks of Tandy Corporation.

CONTENTS

A Quick Look at Your PRO-2025	4
Front Panel	4
Rear Panel	4
Accessories	4
Preparation	5
Mounting the Scanner	5
Connecting the Antenna	6
Using an External Scanner Speaker	6
Connecting to Power	7
Home Installation	8
Understanding Your Scanner	9
A Look at the Display and Indicator	9
A Look at the Keyboard	9
Operation	10
Programming Your Scanner	10
Setting the Volume and Squelch Controls	11
Scanning the Channels	11
Locking Out Channels	11
Using the Priority Feature	12
Manually Selecting a Channel	12
Listening to the Weather Band	12
A General Guide to Scanning	13
Birdies	13
Reception Notes	13
Guide to the Action Bands	14
Typical Band Usage	15
Troubleshooting	18
If You Have Problems	18
Care and Maintenance	19
Specifications	20

A QUICK LOOK AT YOUR PRO-2025

FRONT PANEL

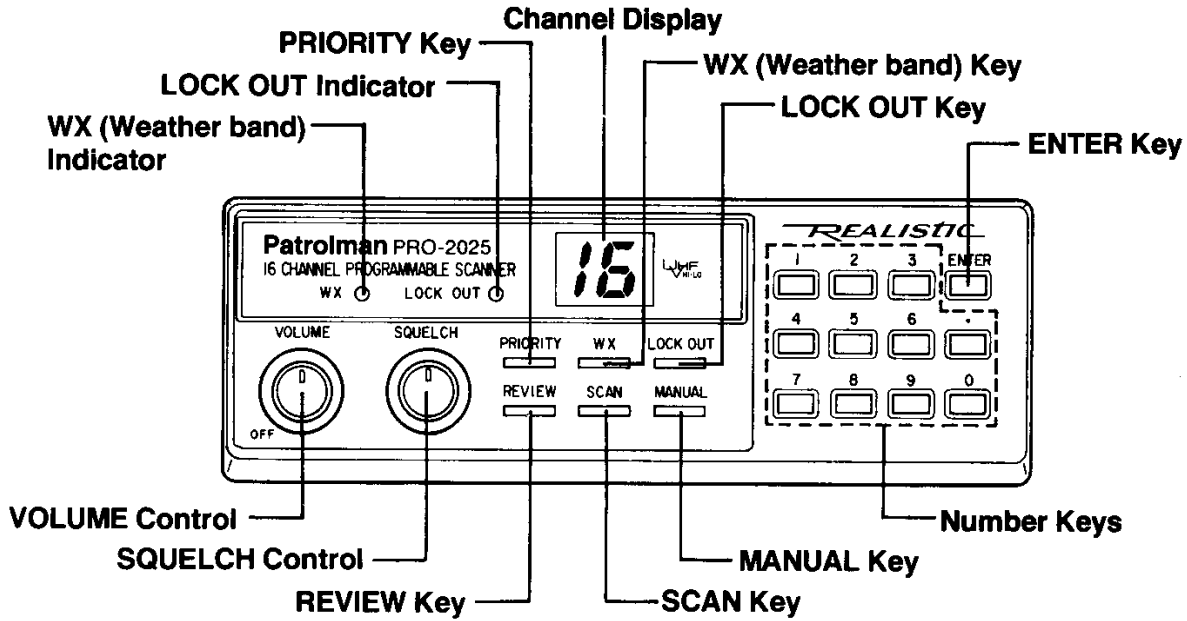

REAR PANEL

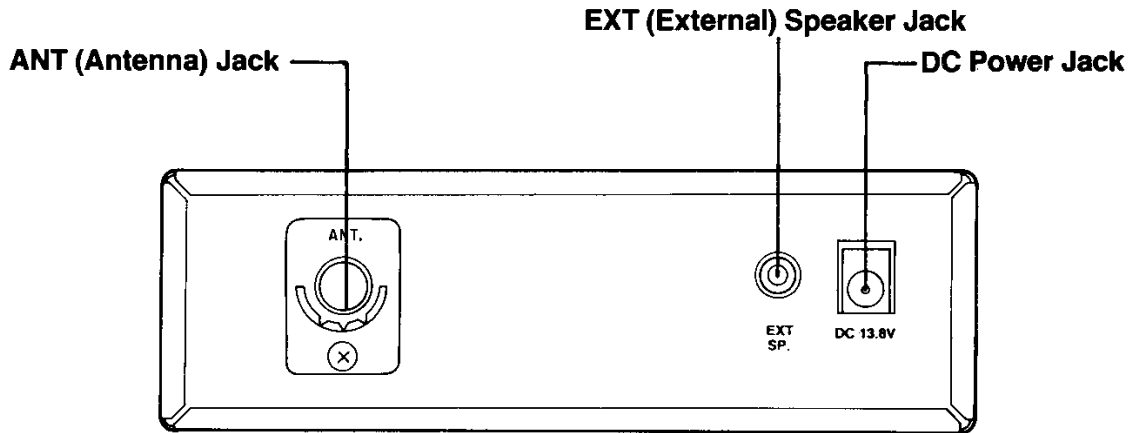

ACCESSORIES



Two
Lock
Washers



Two
Self-tapping
Screws



Two
Mounting
Knobs

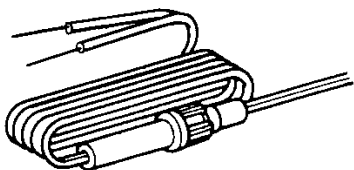

Power Cord

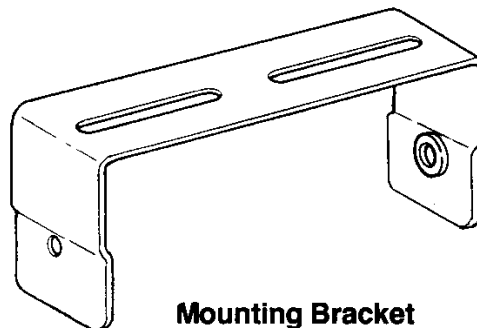

Mounting Bracket

PREPARATION

MOUNTING THE SCANNER

The most common mounting location for this scanner is under your vehicle's dashboard. When choosing a location, be sure the scanner is easy to reach, all cables are clear of the vehicle pedals or

other moving parts, and the radio is not directly in front of heating vents. Also, be sure that the radio is located so that the passengers have enough leg room.

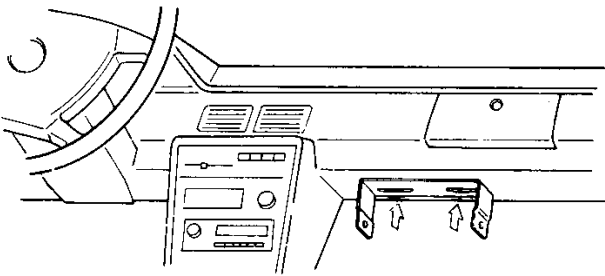
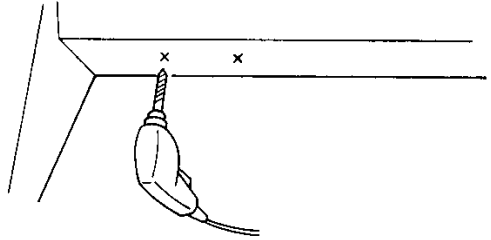
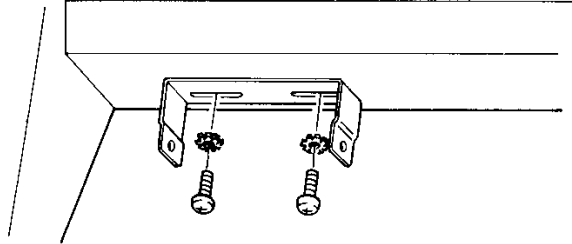
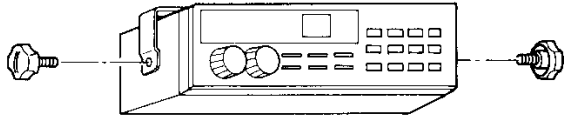
<p>1. Choose a mounting location. Then, use the mounting bracket as a template to mark the positions for the mounting screw holes.</p>	
<p>2. In the marked positions, drill holes slightly smaller than the screws. Take care not to drill into or damage objects behind the mounting surface.</p>	
<p>3. Attach the bracket using the supplied self-tapping screws and lock washers, as shown.</p>	
<p>4. Attach the radio to the bracket using the mounting knobs.</p>	

CONNECTING THE ANTENNA

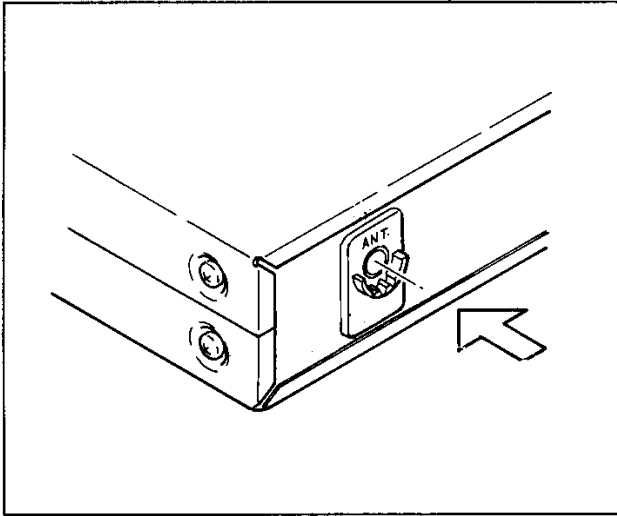

Obtain the magnet-mount mobile all-band antenna (Cat. No. 20-012). Follow the instructions provided with the antenna for installation.

For best results, mount the antenna:

- As high as possible on the vehicle
- In a vertical position

After you mount the antenna, route the antenna's cable to the scanner and connect the cable to the scanner's ANT jack.

Cautions:

- Do not run the cable over sharp edges or moving parts that could damage the cable.
- Do not run the cable next to power cables or other antenna cables.
- Do not run the cable through areas in the engine compartment that produce extreme heat.

USING AN EXTERNAL SCANNER SPEAKER

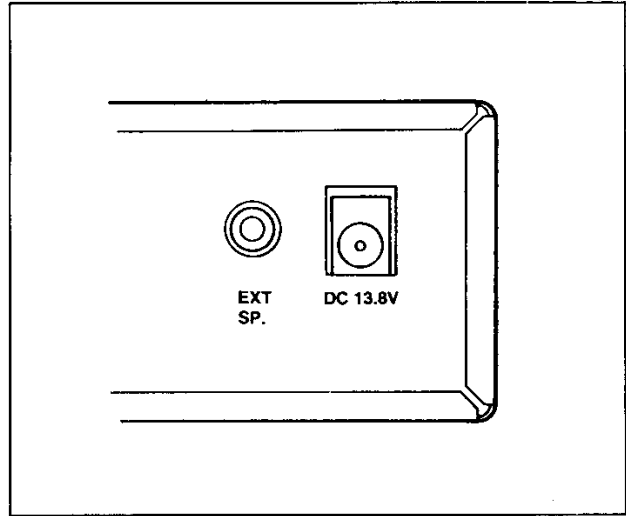

You can connect an external speaker to the scanner. Use a speaker with a 1/8-inch plug, such as Radio Shack Cat. No. 21-549. Insert the plug into the EXT SP. jack on the back of the radio.

CONNECTING TO POWER

We designed your scanner for connection to 13.8-volt power systems. The red and black wires on the power cord packed with your scanner are for power connections.

1. Plug in the single connector end of the power cord to the DC Power jack on the scanner's back panel.

2. Connect the red wire (with the in-line fuse holder) to a terminal that provides power only when you turn the ignition to ON or ACC.

3. Connect the black wire to a metal part of the vehicle's frame (chassis ground).

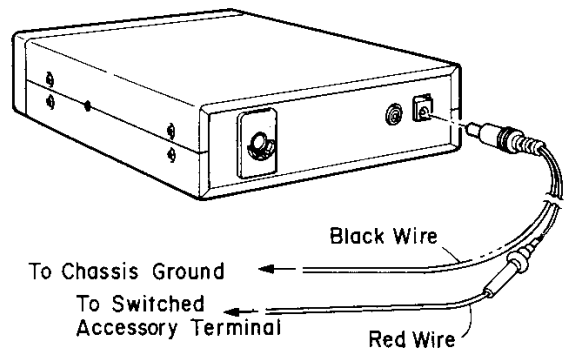

Note: Modern vehicles have many non-metallic parts. If you connect the black wire to a non-metallic part, or if a nonmetallic part insulates the wire from the vehicle's chassis, the scanner does not work.

HOME INSTALLATION

We designed your scanner for mobile use. However, you can also use it in your home. For home installation, you need the following:

- 12-volt DC adapter (Cat. No. 273-1653)
 - Antenna — you can use a simple back-of-set telescoping antenna such as Cat. No. 20-161. To achieve best reception, attach an all-band outdoor antenna.
 - External Speaker (Cat. No. 21-549)
1. Properly mount the antenna and speaker.
 2. Connect the antenna to the scanner's ANT jack.
 3. Connect the external speaker to the scanner's EXT SP jack.
 4. Connect the adapter's green barrel plug to the adapter's cord and set the barrel plug's tip to POS (positive).
 5. Insert the barrel plug into the scanner's DC 13.8V jack.
 6. Plug the adapter's AC power cord into a standard AC outlet.

Warning: When installing or removing outdoor antennas, use extreme caution. If the antenna starts to fall, let it go! It could contact overhead power lines. If the antenna touches the power line, contact with the antenna, mast, cable, or guy wires can cause electrocution and death. Call the power company to remove the antenna. DO NOT attempt to do so yourself.

UNDERSTANDING YOUR SCANNER

A LOOK AT THE DISPLAY AND INDICATOR

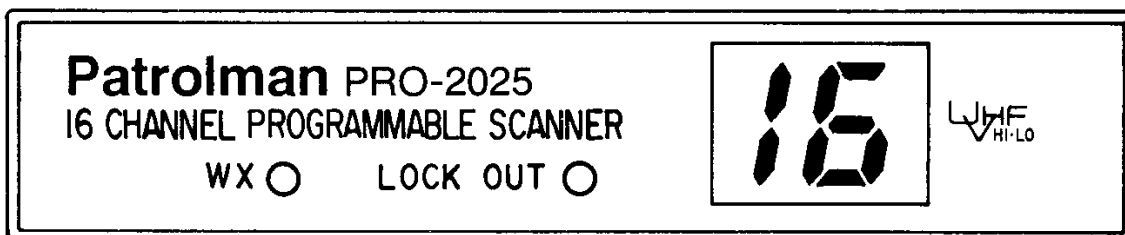

WX Indicator — lights when the scanner is in the weather mode. Flashes when searching for the active weather channel in your area.

LOCK OUT Indicator — lights when you lock a channel out of the scan mode. See “Locking Out Channels.”

Channel Display — normally shows the current channel. E appears when you make an incorrect/invalid entry. P appears when the scanner is in the priority mode. When you program the frequencies or press [REVIEW], the display shows each digit of the frequency being programmed, one at a time. The decimal point is displayed as a dash (—).

A LOOK AT THE KEYBOARD

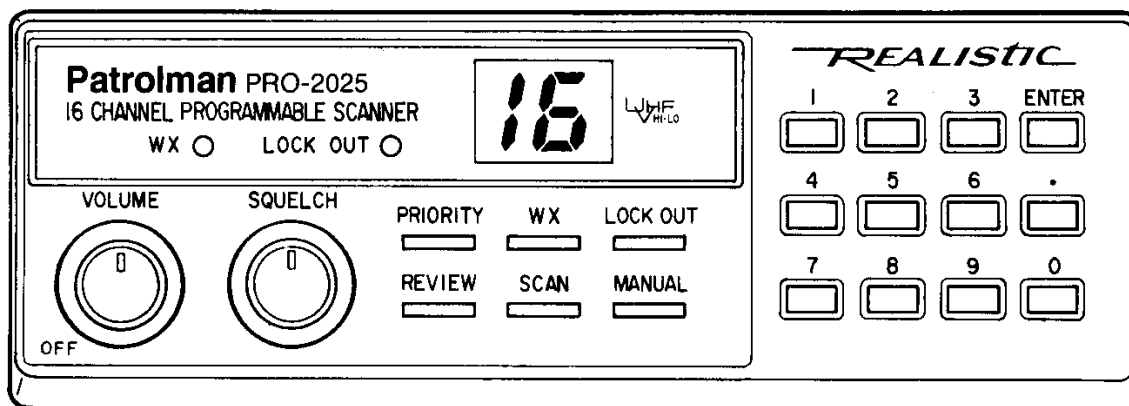

PRIORITY — turns the priority feature on or off for Channel 1.

WX — causes your scanner to scan through the weather channels.

LOCK OUT — turns on the lock-out function. See “Locking Out Channels.”

REVIEW — displays the frequency of the current channel, one digit at a time.

SCAN — causes your scanner to scan through the programmed channels.

MANUAL — stops the scanning and lets you directly enter a channel number.

Number Keys — used to enter a channel number or a frequency.





ENTER — enters the frequency when programming channels.

OPERATION

PROGRAMMING YOUR SCANNER

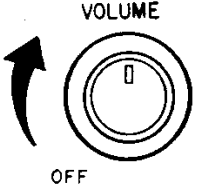
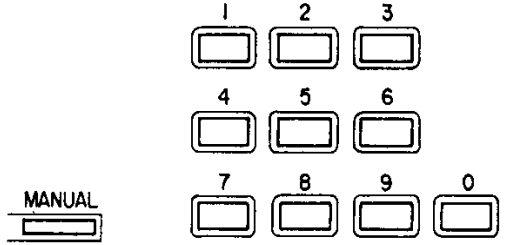
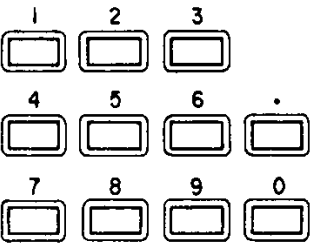
A good reference for active frequencies is Radio Shack's *Police Call Directory including Fire and Emergency Services*.

We update this directory every year, so be sure to get a current copy. Also, refer to "Reception Notes" and "Searching for Active Frequencies".

<p>1. Turn on your scanner by turning VOLUME clockwise. The scanner might start scanning: if so, press [MANUAL] to stop scanning.</p>	
<p>2. Enter the channel number you want to program and press [MANUAL].</p>	
<p>3. Enter a frequency including the decimal point. The decimal point is displayed as a dash (—) on the display.</p>	
<p>4. Press [ENTER] to store the frequency. If you made a mistake in Step 3, E appears on the display. Proceed again from Step 3.</p>	
<p>5. To confirm the proper entry, press [REVIEW]. The programmed frequency appears on the display, one digit at a time.</p>	
<p>6. To program more channels, repeat Steps 2-4. If you want to program the next channel in sequence, simply press [MANUAL] and repeat Steps 3-4.</p>	

Note: Sometimes when you try to enter a frequency for a channel, E appears on the display when you press [ENTER]. This means the frequency is in error and you can not enter it into your PRO-2025.

Such frequency errors usually mean you entered a frequency outside the ranges your PRO-2025 operates on (such as 225.00 MHz) or you put the decimal point in the wrong place (14.682 MHz instead of 146.82 MHz). Check carefully to find your mistake and enter the correct number.

SETTING THE VOLUME AND SQUELCH CONTROLS

Use the SQUELCH control to decrease your scanner's sensitivity to weak signals. This lets the scanner receive only the strongest transmissions.

1. Turn the SQUELCH and VOLUME controls fully counterclockwise.
2. Turn the VOLUME control clockwise until you hear a hissing sound.
3. Slowly turn the SQUELCH control clockwise until the hissing stops.

SCANNING THE CHANNELS

To begin scanning the channels, press [SCAN]. Your scanner scans through all the channels except the ones you have locked out. Be sure to read the following sections to get the full benefit from your scanner's special features.

LOCKING OUT CHANNELS

You can make your scanner scan more efficiently by locking out channels that you have not programmed. Enter the channel number you wish to lock out, press [MANUAL] and then press [LOCK OUT] so that the LOCK OUT indicator lights. This is also handy for locking out channels that have a continuous transmission. You can still manually select locked-out channels for listening.

To unlock a channel you have locked, manually select the channel and press [LOCK OUT] so that the LOCK OUT indicator goes off.

USING THE PRIORITY FEATURE

Channel 1 is designated as your scanner's priority channel. You can turn on the priority feature so that you do not miss transmissions on Channel 1, even if you monitor another channel.

Press [PRIORITY]. Now your scanner checks Channel 1 every 2 seconds (P appears on the display momentarily), and stays on the channel if there is any activity. Press [PRIORITY] again to disable the priority function.

MANUALLY SELECTING A CHANNEL

You can continuously monitor a single channel without scanning. This is useful if you hear an emergency broadcast on a channel and do not want to miss any of the details — even though there might be periods of silence — or if you want to monitor a channel that you have locked out.

To select a channel to monitor, press [MANUAL] and advance through the channels by pressing [MANUAL] repeatedly, or move directly to a channel by entering the channel number on the keypad then pressing [MANUAL]. If your scanner is scanning and has stopped at the desired channel, press [MANUAL] one time.

LISTENING TO THE WEATHER BAND

The FCC (Federal Communications Commission) has allocated several channels for use by the National Oceanic and Atmospheric Administration (NOAA). We preprogrammed your scanner with all of the frequencies available to NOAA. To hear your local forecast and regional weather information, press [WX]. Your scanner begins scanning through the weather band, and the WX indicator lights.

Your scanner should stop within a few seconds, and you hear the local weather broadcast. If the broadcast is weak, you can press [WX] again to scan through the rest of the weather band.

To exit the WX mode, press either [SCAN] or [MANUAL].

A GENERAL GUIDE TO SCANNING

BIRDIES

Birdies are the products of internally generated signals that make some frequencies difficult or impossible to receive. If you program one of these frequencies, you hear only noise on that frequency.

If the interference is not severe, you might be able to cut out the birdie by turning the SQUELCH control clockwise. The most common birdies to watch for are listed below.

31.200 MHz

41.600 MHz

RECEPTION NOTES

Reception of the frequencies covered by your scanner is mainly "line of sight." That means that you usually cannot hear stations at your listening location that extend beyond the horizon.

During the summer months, you might be able to hear stations in the 30-50 MHz range located several hundred or even thousands of miles away. This is caused by summer atmospheric conditions. This type of reception is unpredictable but often very interesting.

GUIDE TO THE ACTION BANDS

With a little investigation, you can find the active frequencies in your community to monitor exciting events. We can give you some general pointers on finding these frequencies and you can take it from there. Please use caution and common sense when you hear an emergency call. Never go to the scene of an emergency. It could be very dangerous.

Find out if there is a local club that monitors your community's frequencies. Perhaps a local electronics repair shop that works on equipment similar to your scanner can give you channel frequencies used by local radio services. A volunteer police department or fire department employee can also be a good source for this information.

As a general rule on VHF, most activity concentrates between 153.785 and 155.98 MHz and then again from 153.73 to 159.46 MHz. Here you find local government, police, fire, and most other emergency services. If you are near a railroad or major railroad tracks, look between 160.0 to 161.9 for signals.

In some larger cities, there has been a move to the UHF bands for emergency services. Here, most of the activity is between 453.025 and 453.95 MHz and again between 456.025 and 459.95 MHz.

In the UHF band, mobile and control units associated with base and repeater units operate between the frequencies of 456.025 and 459.95 MHz and again between 465.025 and 469.975 MHz. The repeaters operate 5 MHz lower than the base and mobile units (that is, 451.025 to 454.95 MHz and 460.025 to 464.975 MHz). This means that if you find an active frequency inside one of these spreads, you can look 5 MHz lower (or higher, as the case may be) to find that radio service.

Frequencies in different bands are accessible only at specific intervals. However, the frequencies that you can store into your scanner's memory are in 5 or 12.5 kHz steps. Your scanner automatically rounds the entered frequency down to the nearest valid frequency. For example, if you try to enter a frequency of 151.473, your scanner accepts it as 151.475.

TYPICAL BAND USAGE

The following is a brief listing of the services typical of the bands received by your scanner. This listing can help you decide which ranges you would like to scan.

Abbreviations:

Affiliate Radio System	MARS
Amateur	Ham
Automobile Emergency	Auto Emer.
Broadcast Remote	BC. R.
Bureau of Reclamation	Bur. Recl.
Civil Air Patrol	CAP
Department of Agriculture and Forestry	Agr. and For.
Fire Department	F.D.
Forest Products	For. Prod.
Forestry Conservation	Fors. Cons.
Government	Govt.
Highway Maintenance	Hwy.
Land Transportation	Land Tr.
Local Government	L. Govt.
Manufacturers	Mfg.
Military	MIL
Mobile Telephone	Mob. Tel.
Motion Picture	Mot. P.
Motor Carrier	Buses. Trucks
National Parks	Nat. Park
Petroleum	Pet.
Police	P.D.
Power Utilities	Power
Radio Paging	Page
Railroad	R.R.
Relay Press	Press
State Police	St. P.D.
Special Emergency	Sp. Ind.
Taxicab Radio	Taxi
Telephone Maintenance	Tel. Maint.
U.S. Coastal and Geodetic Survey	U.S.C.G.S.
U.S. Navy	USN
U.S. Weather Bureau	U.S.W.B.

29 - 54 MHz BAND

29.00 - 29.70	10HAM
29.70 - 29.80	For. Prod.
29.80 - 30.00	Aero.
30.01 - 30.56	Govt.
30.56 - 30.62	Sp. Ind.
30.66 - 31.24	Ind. (Pet., For. Cons., Bus., For. Prod.)
31.26 - 31.98	Sp. Ind., For. Cons.
32.00 - 33.00	Govt.
33.02 - 33.16	Hwy., Sp. Emer., Bus.
33.18 - 33.38	Pet.
33.42 - 33.98	F.D.
34.00 - 35.00	Govt.
35.02 - 35.18	Bus.
35.22 - 35.66	Mob. Tel. & Page
35.70 - 35.72	Bus.
35.74 - 35.98	Sp. Ind. & Bus
36.00 - 37.00	Govt.
37.02 - 37.44	P.D. & L. Govt.
37.46 - 37.86	Power
37.90 - 37.98	Hwy. & Sp. Emer.
38.00 - 39.00	Govt.
39.02 - 39.98	P.D., L. Govt.
40.00 - 42.00	Govt.
42.02 - 42.94	St. P.D.
42.96 - 43.18	Sp. Ind. & Bus.
43.22 - 43.68	Mob. Tel. Page
43.70 - 44.60	Trucks. Bus.
44.62 - 45.06	St. P.D., For. Cons.
45.08 - 45.66	P.D.
45.68 - 46.04	P.D. Hwy., Sp. Emer.
46.06 - 46.50	F.D.
46.52 - 46.58	L. Govt.
46.60 - 47.00	Govt.
47.02 - 47.40	St. Hwy.
47.42	Red Cross
47.44 - 47.68	Sp. Ind. Sp. Emer.
47.70 - 48.54	Power
48.56 - 49.58	For. Prod., Pet.
49.60 - 50.00	Govt.
50.00 - 54.00	6 Meter Amateur (Ham) Band

136 - 174 MHz BAND

136.000 - 144.000 Govt.
144.000 - 148.000 HAM
148.010 MARS
148.150 CAP
148.155 - 148.250 MIL
148.290 - 150.750 USN
150.815 - 150.995 Bus.
151.010 - 151.130 HWY
151.145 - 151.475 For. Cons.
151.505 - 151.595 Sp. Ind.
151.625 - 151.955 Bus.
151.985 - 152.240 Mob. Tel. (RCC)
152.270 - 152.450 Taxi
152.480 - 152.840 Mob. Tel. Page
152.870 - 153.020 Sp. Ind. Mot. P.
153.050 - 153.440 Pet., For. Prod.
153.470 - 153.710 Power
153.740 - 154.115 L. Govt.
154.130 - 154.445 F.D.
154.450 - 154.600 Sp. Ind., Pet., Bus.
154.655 - 155.145 P.D., L. Govt., St. P.D.
155.160 - 155.400 Sp. Emer., P.D.
155.415 - 156.030 P.D., L. Govt.
156.045 - 156.240 Hwy., P.D.
156.275 - 157.425 Marine
157.456 - 157.500 Auto Emer.
157.530 - 157.710 Taxi
157.740 - 158.100 Mob. Tel., Page
158.130 - 158.460 Power, For. Prod., Pet.
158.490 - 158.700 Mob. Tel. (RCC)
158.730 - 158.970 P.D., L. Govt.
158.985 - 159.210 P.D. Hwy.
159.225 - 159.465 For. Cons.
159.510 - 160.200 Trucks
160.215 - 161.565 R.R.
161.600 - 162.000 Marine
162.026 - 162.175 Bur. Recl.
162.400 U.S.W.B.
162.550 U.S.W.B.
163.125 Indian Affairs
163.175 Bur. Recl.
163.275 U.S.W.B.
163.388 - 163.538 MIL
163.825 - 163.975 Govt.

164.025 - 164.075 U.S.C.G.S.
164.175 - 165.188 Bur. Recl. Nat. Pk.
Govt., Agr. & For.
169.300 F.A.A.
169.450 - 169.725 Ind., Data
170.150 F.D., BC. R.
170.200 - 170.220 U.S.C.G.S.
170.225 - 170.325 Ind., Land Tr.
170.425 - 170.575 For. Cons.
170.975 - 171.250 Govt. Ind., Land Tr.
171.388 - 172.725 Bur. Recl., For. Cons.,
Ind., Dept. Ag. & For., Govt.
172.775 Nat. Pk.
173.025 U.S.W.B.
173.075 U.S.C.G.S.
173.204 Mot. P., Pet., Bur. Recl.
Press Relay.

406 - 512 MHz BAND

406.000 - 420.000 Govt.
420.000 - 450.000 HAM
450.050 - 450.950 Remote Br.
451.000 - 451.150 Util.
451.175 - 451.750 For. Prod., Pet.,
Power., Tel. Maint.
451.775 - 451.975 Spec. Ind.
452.000 - 452.500 Taxi, Mot. Carrier, R.R.
452.525 - 452.600 Auto Club
452.625 - 452.975 Motor Carr., R.R.
453.000 - 453.975 L. Govt., P.D., F.D.
454.000 - 454.975 Mob. Tel.
455.000 - 455.975 Remote Br.
456.000 - 458.975 P.D., F.D., Ind., Lan. Tr.
459.000 - 459.975 Domestic Public
460.000 - 460.625 P.D., F.D.
460.650 - 462.175 Bus.
462.200 - 462.450 Taxi
462.750 - 462.975 Bus.
463.000 - 463.175 Medical
463.200 - 464.975 Bus.
465.000 - 467.500 P.D., F.D., Ind., Land Tr.
467.750 - 467.925 Bus.
467.7375 - 469.975 Pub. Safety. Ind.,
Land Tr.

TV Bands for Special Communications

470 - 476 T.V. Channel 14
476 - 482 T.V. Channel 15
482 - 488 T.V. Channel 16
488 - 494 T.V. Channel 17
494 - 500 T.V. Channel 18
500 - 506 T.V. Channel 19
506 - 512 T.V. Channel 20

6 MHz Segment is allocated for Channel 14

470.0125 - 470.2875	. . . Domestic Public, (Base, Mob.)
470.3125 - 471.1375 Public Safety
471.1625 - 471.2875 Reserve Pool A
471.3125 - 471.4125 Pwr., Tel. Maint.
471.4375 - 471.6375 Spec. Ind.
471.6625 - 471.7875 Reserve Pool B
471.8125 - 472.3375 Bus.
472.3625 - 472.4375 Taxi
472.4675 - 472.7875	. R.R., Motor Carrier, Auto Emer.
472.8125 - 472.9875	Pet., For. Prod., Mfg.
473.0125 - 473.2875 Domestic Public
473.3125 - 474.1375 Public Safety
474.1625 - 474.2875 Reserve Pool A
474.3125 - 474.4125 Pwr., Tel. Maint.
474.4375 - 474.6375	. . Spec. Ind. (Mobile)
474.6625 - 474.7875 Reserve Pool B
474.8125 - 475.3375 Bus.
475.3625 - 475.4375 Taxi
475.4625 - 475.7875	. R.R., Motor Carrier, Auto Emer.
475.8125 - 475.9876	. Pet., For. Prod. Mfg.

These frequencies are subject to change and might vary some from area to area. For a more complete listing, refer to the Police Call Radio Guide Including Fire and Emergency Services available at your local Radio Shack store.

You might discover one of your regular stations on a frequency that is not listed. This could be what is known as an "image." For example, if you suddenly find 453.2750 you also hear on 474.9750, do a little math to see if it is an image. Take the intermediate frequency of 10.85 MHz and double it. Then, subtract it from the "new" frequency. If the answer is the regular frequency, you have tuned to an image. Occasionally you might get interference on a weak or distant channel from a strong broadcast 21.7 MHz (10.85 MHz x 2) below the tuned frequency. This is rare, and image signal usually clears whenever a broadcast on the actual frequency is in progress.

TROUBLESHOOTING

IF YOU HAVE PROBLEMS...

Here are some suggestions which might help.

PROBLEM	POSSIBLE CAUSE	REMEDY
Scanner is totally inoperative.	No power.	Check the power connection. Also check the in-line fuse. If it is blown, replace with identical one.
Scanner is on but will not scan.	The SQUELCH control is not correctly adjusted.	Adjust the SQUELCH control clockwise.
In the scan mode the scanner locks on frequencies that have an unclear transmission.	"Birdies"	Avoid programming frequencies listed on Page 13, or only listen to them manually.

If none of these suggested remedies solves the problem, return your scanner to your local Radio Shack store for assistance.

CARE AND MAINTENANCE

Your Realistic PRO-2025 programmable scanner is an example of superior design and craftsmanship. The following suggestions will help you care for the PRO-2025 so that you can enjoy it for years.

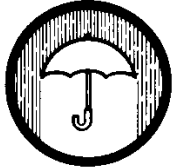

Keep the scanner dry. If it does get wet, wipe it dry immediately. Liquids can contain minerals that can corrode the electronic circuits.



Handle the scanner gently and carefully. Dropping it can damage circuit boards and cases and can cause the product to work improperly.



Use and store the scanner only in normal temperature environments. Extreme temperatures can shorten the life of electronic devices and distort or melt plastic parts.



Keep the scanner away from dust and dirt, which can cause premature wear of parts.



Wipe the scanner with a dampened cloth occasionally to keep it looking new. Do not use harsh chemicals, cleaning solvents, or strong detergents to clean the scanner.

Modifying or tampering with the scanner's internal components can cause a malfunction and might invalidate the scanner's warranty. If your scanner is not operating as it should, take it to your local Radio Shack store for assistance.

SPECIFICATIONS

Frequency Coverage:

VHF-Lo	29 - 50 MHz (in 5 kHz steps)
Ham	50 - 54 MHz (in 5 kHz steps)
Government	136 - 144 MHz (in 5 kHz steps)
Ham	144 - 148 MHz (in 5 kHz steps)
VHF-Hi	148 - 174 MHz (in 5 kHz steps)
Ham/Government	406 - 450 MHz (in 12.5 kHz steps)
UHF-Lo	450 - 470 MHz (in 12.5 kHz steps)
UHF-Hi (TV)	470 - 512 MHz (in 12.5 kHz steps)

Channels of Operation Any 16 channels in any band combinations

Sensitivity (20 dB signal-to-noise ratio at ± 3 kHz deviation)

29 - 54 MHz	0.5 μ V
136 - 174 MHz	0.8 μ V
406 - 512 MHz	1.0 μ V

Spurious Rejection (except image frequency):

29 - 54 MHz	40 dB at 40 MHz
136 - 174 MHz	55 dB at 155 MHz
406 - 512 MHz	55 dB at 460 MHz

Selectivity:

± 11 kHz.	-6 dB
± 15 kHz.	-50 dB

IF Rejection:

10.85 MHz	70dB at 155 MHz
-----------	-----------------

Scanning Rate 12 channel/sec.

Delay Time 2 seconds

Modulation Acceptance ± 12 kHz

Intermediate Frequencies 10.85 MHz and 450 kHz

Filters 1 crystal filter,
1 ceramic filter

Squelch Sensitivity	Threshold: Less than 1.0 μ V Tight: (S + N)/N 25 dB
Antenna Impedance	50 ohms
Audio Power	2.2 watts maximum, 4 ohms
Built-in Speaker	3" (77mm) 4 ohm, dynamic type
Power Requirements	13.8 VDC (\pm 10%)
Current Drain	DC 180 mA (squelched) DC 520 mA (full volume unsquelched)
Dimensions	1 $\frac{3}{4}$ " (45mm) x 5 $\frac{1}{2}$ " (140mm) x 6 $\frac{7}{8}$ " (175mm) HWD
Weight	1.8 lbs (800 g)

RADIO SHACK LIMITED WARRANTY

This product is warranted against defects for 1 year from date of purchase from Radio Shack company-owned stores and authorized Radio Shack franchisees and dealers. Within this period, we will repair it without charge for parts and labor. Simply **bring your Radio Shack sales slip** as proof of purchase date to any Radio Shack store. Warranty does not cover transportation costs. Nor does it cover a product subjected to misuse or accidental damage.

EXCEPT AS PROVIDED HEREIN, RADIO SHACK MAKES NO WARRANTIES, EXPRESS OR IMPLIED, INCLUDING WARRANTIES OF MERCHANTABILITY AND FITNESS FOR A PARTICULAR PURPOSE. Some states do not permit limitation or exclusion of implied warranties; therefore, the aforesaid limitation(s) or exclusion(s) may not apply to the purchaser.

This warranty gives you specific legal rights and you may also have other rights which vary from state to state.

We Service What We Sell

RADIO SHACK
A Division of Tandy Corporation
Fort Worth, Texas 76102

UBRS01214ZZ
Printed in the Philippines