

Please read before using this equipment.

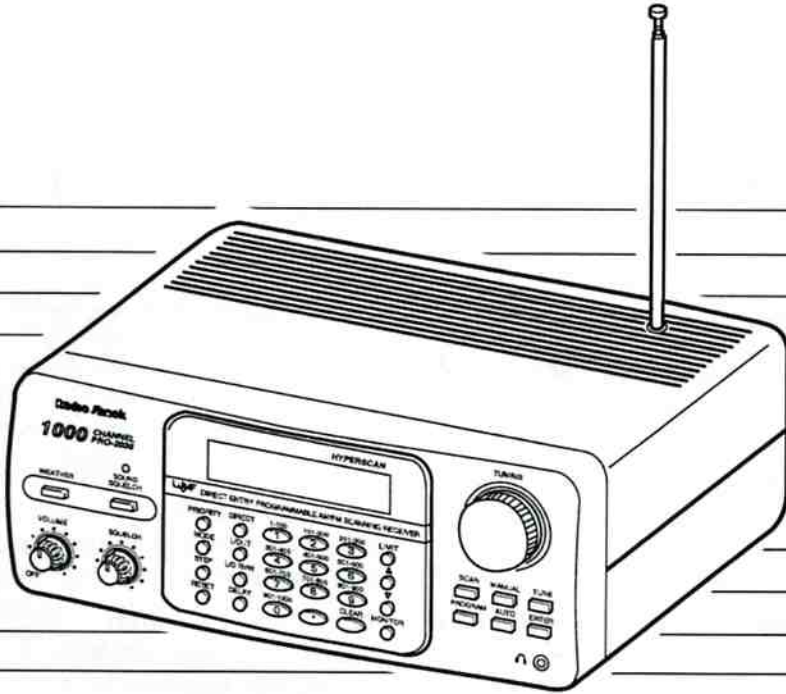

Cat. No. 20-460

**Radio Shack®**

# INTRODUCTION

---

Your new Radio Shack PRO-2035 1000-Channel Programmable Home Scanner lets you in on all the action! With its convenient rotary tuner and keypad, you can quickly tune to over 196,000 frequencies that include those used by police and fire departments, ambulance services, aircraft communications, amateur radio services, transportation services, Citizen's Band and commercial FM and television broadcasters. You can select up to 1,000 channels to scan and you can change your selections at any time.

The secret to your scanner's ability to scan so many frequencies is its custom-designed microprocessor — a tiny, built-in computer.

Your scanner has all these special features.

**Hyperscan** — lets you scan and search up to 50 channels or steps per second.

**Weather Band Key** — scans ten pre-programmed weather frequencies to keep you informed about current weather conditions.

**Ten Channel-Storage Banks** — you can store 100 channels in each bank to group channels so calls are easier to identify.

**Monitor Memory** — temporarily saves up to 100 frequencies located during a frequency search, letting you move selected frequencies to permanent channel storage later.

**Priority Channel** — you can set the scanner to check one channel every 2 seconds so you do not miss important calls.

**Auto Store** — quickly finds and automatically stores active frequencies in channels, then searches for additional active frequencies while skipping previously stored channels.

**TAPE OUT Jack** — lets you connect an optional tape recorder to the scanner to record transmissions.

**Rotary Tuner** — lets you manually tune and select desired frequencies or channels.

**Two-Second Channel Scan Delay** — delays scanning for 2 seconds before moving to another channel so you can hear more replies.

**Memory Backup** — keeps channel frequencies stored in memory for up to 3 months during a power loss.

**Lock-Out Function** — keeps selected channels from being scanned, so you can skip over busy channels.

© 1994 Tandy Corporation.  
All Rights Reserved.

Radio Shack is a registered trademark used by Tandy Corporation.

**Direct Frequency Search** — lets you scan for new and unlisted frequencies.

**Sound Squelch** — keeps the scanner from stopping on frequencies with only a carrier signal and no voice or other sound, so you can hear calls instead of static.

**Backlit Display** — makes it easy to view and change programming information.

**Two Power Options** — let you power the scanner from standard AC power (with the supplied AC power cord), or your vehicle's battery (with an optional DC cigarette lighter power cord).

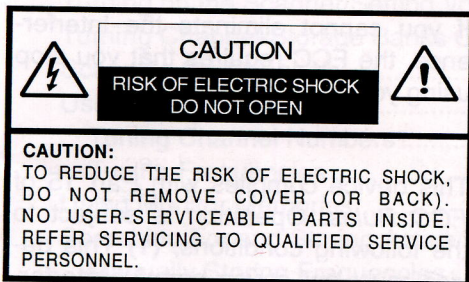

**Warning: To reduce the risk of fire or electric shock, do not expose this appliance to rain or moisture.**

 This symbol is intended to alert you to the presence of dangerous voltage inside the product that presents a risk of electric shock. Do not open the product's case.

 This symbol is intended to tell you that important operating and maintenance instructions are contained in this owner's manual.

Your PRO-2035 scanner can receive all of these bands:

- 25–28 MHz (HF Hi)
- 28–29.7 MHz (10-Meter Amateur Radio)
- 29.7–50 MHz (VHF Lo)
- 50–54 MHz (6-Meter Amateur Radio)
- 54–72 MHz (FM-TV Audio Broadcast, Wide Band)
- 72–76 MHz (Land Mobile Service Band)
- 76–88 MHz (FM-TV Audio Broadcast, Wide Band)
- 88–108 MHz (FM Radio Broadcast, Wide Band)
- 108–136.975 MHz (Aircraft)
- 137–144 MHz (Government)
- 144–148 MHz (2-Meter Amateur Radio)
- 148–174 MHz (VHF Hi)
- 174–216 MHz (FM-TV Audio Broadcast, VHF Wide Band)
- 216–224.9875 MHz (VHF Hi, 1<sup>1</sup>/<sub>4</sub>-Meter Amateur Radio)
- 225–399.9875 MHz (Military Aircraft)
- 400–450 MHz (UHF Lo, 70-Centimeter Amateur Radio, Government)
- 450–470 MHz (UHF Lo)
- 470–520 MHz (UHF "T" Band)

- 760–805.750 MHz (UHF “T” Band)
- 806–823.9875 MHz (UHF Public Service)
- 849.0125–868.9875 MHz (UHF Hi)
- 894.0125–956 MHz (UHF Hi, 33-Centimeter Amateur Radio)
- 956–1300 MHz (Private Fixed Services, Paging, Aircraft Navigation, Experimental, 23-Centimeter Amateur Radio)

Your scanner can receive these pre-programmed weather channels:

- 161.650 MHz
- 161.775 MHz
- 162.400 MHz
- 162.425 MHz
- 162.450 MHz
- 162.475 MHz
- 162.500 MHz
- 162.525 MHz
- 162.550 MHz
- 163.275 MHz

For your permanent records, we urge you to record your scanner’s serial number in the space below. The serial number is located on the scanner’s back panel.

Serial Number: \_\_\_\_\_

## FCC NOTICE

Your scanner might cause TV or radio interference even when it is operating properly. To determine whether or not your scanner is causing the interference, turn off your scanner. If the interference goes away, your scanner is causing it. Try to eliminate the interference by:

- Moving your scanner away from the receiver.
- Connecting your scanner to an outlet that is on a different electrical circuit from the receiver.
- Contacting your local Radio Shack store for help.

If you cannot eliminate the interference, the FCC requires that you stop using your scanner.

This device complies with Part 15 of *FCC Rules*. Operation is subject to the following conditions; (1) This device must not cause harmful interference, and (2) this device must accept any interference received, including interference that may cause undesired operation.

# CONTENTS

PREPARATION .....	7
Connecting an Antenna .....	7
Connecting Power .....	8
Using Your Vehicle's Battery .....	9
Restarting/Resetting the Scanner.....	9
CONNECTING OPTIONAL EQUIPMENT .....	11
Connecting an External Speaker.....	11
Connecting Headphones .....	11
Listening Safely.....	11
Connecting a Tape Recorder.....	12
UNDERSTANDING YOUR SCANNER.....	13
A Look at the Keyboard .....	13
A Look at the Display.....	14
UNDERSTANDING BANKS .....	16
Channel-Storage Banks .....	16
Monitor Memories.....	16
OPERATION.....	17
Turning on the Scanner/Setting Volume and Squelch .....	17
Turning Channel-Storage Banks On and Off.....	17
Scanning the Channels .....	17
Using the Rotary Tuner.....	18
Tuning Channel Numbers .....	18
Tuning Frequencies .....	18
Using Monitor Memories.....	18
Searching For and Storing Active Frequencies .....	19
Manually Storing Frequencies .....	19
Automatically Storing Frequencies .....	20
Limit Search .....	21
Direct Search .....	23
Moving Frequencies .....	23
Moving a Frequency from a Monitor Memory to a Channel.....	23
Moving Frequencies from Monitor Memories to Banks.....	24
Moving Frequencies within Banks .....	25
Moving Frequencies from Banks to Monitor Memory .....	25
Deleting Frequencies.....	25
Deleting a Frequency from a Channel or Monitor Memory .....	25
Deleting Frequencies from Locked-Out Channels within a Bank.....	26
Deleting All Frequencies from Channels within a Bank .....	26

SPECIAL FEATURES.....	27
Delay .....	27
Using the ATT Switch.....	27
Using the Sound Squelch Switch .....	27
Locking Out Channels .....	28
Reviewing Locked-Out Channels.....	28
Priority .....	28
Manually Selecting a Channel.....	29
Listening to the Weather Band .....	29
Band Mode and Frequency Step.....	29
Changing/Resetting the Band Mode.....	30
Changing/Resetting the Frequency Step.....	31
A GENERAL GUIDE TO SCANNING .....	32
Guide to Frequencies .....	32
National Weather Frequencies .....	32
Ham Radio Frequencies .....	32
Citizens Band Frequencies .....	33
Birdie Frequencies.....	34
Guide to the Action Bands .....	35
United States Broadcast Bands.....	35
International Broadcast Bands.....	35
Typical Band Usage.....	36
Primary Usage .....	37
Specified Intervals.....	38
Band Allocation.....	38
Frequency Conversion .....	41
TROUBLESHOOTING.....	42
CARE AND MAINTENANCE .....	43
SPECIFICATIONS .....	44

# PREPARATION

This scanner is primarily designed for use in the home as a base station. You can place it on a desk, shelf, or table.

Your scanner's front feet fold up or down. Adjust them to give you the best view of the display.

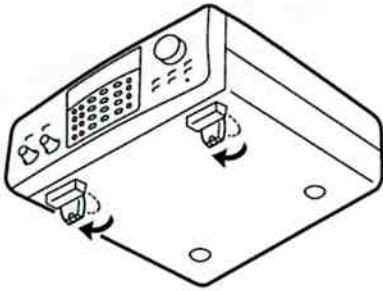

The scanner's sensitivity depends on the antenna's length and various environmental conditions. For the best reception of the transmissions you want to hear, adjust the antenna's length.

Frequency	Antenna Length
25–300 MHz	Extend fully
300–520 MHz	Extend three segments
760–1300 MHz	Collapse all segments

## CONNECTING AN ANTENNA

The supplied telescoping antenna helps your scanner receive strong local signals. To install the antenna, screw it clockwise into the hole on the scanner's top.

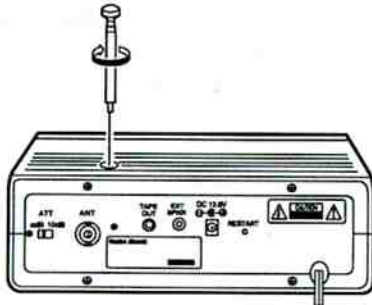

Instead of the supplied antenna, you can connect an outdoor base antenna (not supplied) to your scanner. Your local Radio Shack store sells a variety of antennas. Choose the one that best meets your needs.

When deciding on an outdoor base antenna and its location, consider the following:

- The location of the antenna should be as high as possible.
- The antenna and antenna cable should be as far as possible from sources of electrical noise (appliances, other radios, and so on).
- The antenna should be vertical for the best performance.

To connect an optional antenna, always use 50-ohm coaxial cable, such as RG-58 or RG-8. For lengths over 50 feet, use RG-8 low-loss dielectric coaxial cable. If the coaxial cable's connector does not fit in the **ANT** jack, you might also need a PL-259-to-BNC antenna plug adapter, such as Cat. No. 278-120. Your local Radio Shack store carries a wide variety of coaxial antenna cable and connectors.

Follow the mounting instructions supplied with the antenna. Then route the antenna cable to the scanner, and connect it to the **ANT** jack on the back of the scanner.

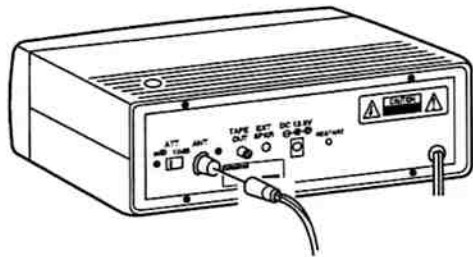

**Caution:** Do not run the cable over sharp edges or moving objects.

**Warning:** Use extreme caution when you install or remove an outdoor antenna. If the antenna starts to fall, let it go! It could contact overhead power lines. If the antenna touches a power line, contact with the antenna, mast, cable, or guy wires can cause electrocution and death. Call the power company to remove the antenna. **DO NOT** attempt to do so yourself.

## CONNECTING POWER

Plug the scanner's attached AC power cord into a standard AC outlet.

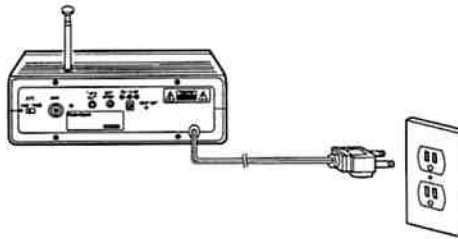

**Caution:** To prevent electric shock, the plug's blades are polarized and fit only one way. If the plug does not fit easily, turn it over and try again. Do not force the plug into the AC outlet.

The memory backup circuit begins to function a few minutes after you supply power to the scanner. The length of time that the scanner maintains channels stored in memory depends on how long power has been supplied to the scanner. For example, if power is supplied to the scanner for at least 4 days, the memory backup circuit maintains the channels stored in memory for up to 3 months.



## Using Your Vehicle's Battery

If your AC power does not work in an emergency, you can power your scanner from your vehicle's cigarette lighter socket with an optional DC cigarette lighter power cable such as Cat. No. 270-1533 (not supplied).

To connect an optional DC cigarette lighter power cable, insert its barrel plug into the **DC 13.8V** jack on the back of the scanner, then plug the power cable into your vehicle's cigarette lighter socket.

### Cautions:

- The scanner can work in a vehicle that has a 12-volt, negative-ground electrical system. Most vehicles have this type of system. If you are not sure about your vehicle, check with your vehicle's dealer.
- If you use a DC cigarette lighter power cable with the scanner, it must supply 12 volts and deliver at least 1 amp. Its center tip must be set to positive, and its plug must correctly fit the **DC 13.8V** jack on the back of the scanner. The recommended power cable meets these specifications. Using a power cable that does not meet these specifications could seriously damage the scanner or the power cable.

**Note:** Mobile use of this scanner is unlawful or requires a permit in some areas. Check the laws in your area.

## RESTARTING/RESETTING THE SCANNER

If the scanner's display locks up or the scanner does not work properly after you connect power, you might have to restart or reset the scanner.

Restarting the scanner clears and resets the scanner's display, but does not erase any channel information stored in the scanner's memory. Follow these steps to restart the scanner.

1. Turn off the scanner, then turn it on again.

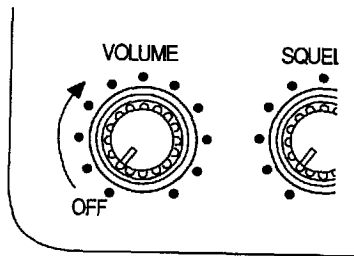

2. Insert a pointed object such as a straightened paper clip into the **RESTART** hole on the back of the scanner for about 2 seconds.

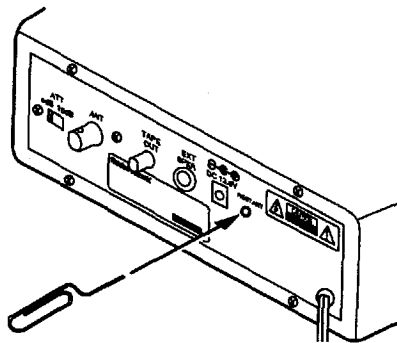

If the scanner still does not work properly, you might have to reset it.

**Caution:** This procedure clears all the information you have programmed into the scanner. Use this procedure only when you are sure your scanner is not working properly.

1. Turn off the scanner, then turn it on again.
2. Press and hold down **CLEAR**, and insert a pointed object such as a straightened paper clip into the **RE-START** hole on the back of the scanner for about 2 seconds. Information on the scanner's display disappears.
3. When information reappears on the scanner's display, release **CLEAR**.

# CONNECTING OPTIONAL EQUIPMENT

## CONNECTING AN EXTERNAL SPEAKER

You can connect an optional external speaker with a 1/8-inch plug to the scanner. Use an 8-ohm external speaker capable of handling over 2.5 watts of power (such as Radio Shack Cat. No. 21-549).

Insert the speaker's plug into the **EXT SPKR** jack on the back of the scanner.

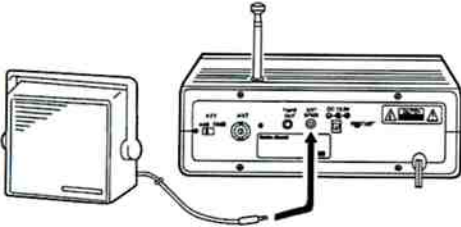

**Note:** Plugging in an external speaker disconnects the scanner's internal speaker.

## CONNECTING HEADPHONES

You can connect an optional pair of headphones with a 1/8-inch plug to the scanner. Use monaural headphones (such as Radio Shack Cat. No. 20-210).

Insert the headphones' plug into the **HEADPHONE** jack on the front of the scanner.

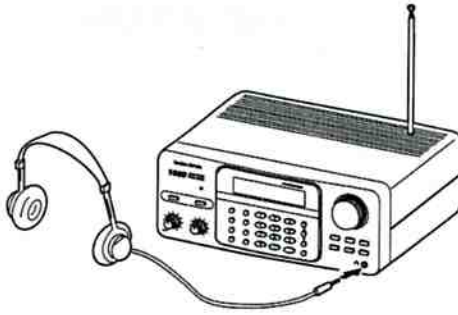

**Note:** Plugging in headphones disconnects the scanner's internal speaker.

## Listening Safely

To protect your hearing, follow these guidelines when you use headphones.

- Set **OFF/VOLUME** to the lowest setting before you begin listening. After you put on the headphones, adjust **OFF/VOLUME** to a comfortable level.
- Do not listen at extremely high volume levels. Extended high-volume listening can lead to permanent hearing loss.
- Once you set **OFF/VOLUME**, do not increase it. Over time, your ears adapt to the volume level, so a volume level that does not cause discomfort might still damage your hearing.

---

---

## CONNECTING A TAPE RECORDER

You can connect an optional tape recorder to your scanner to record transmissions. To record from the scanner, you need a tape recorder with a microphone jack (such as Radio Shack Cat. No. 14-1151). Also, you need a connecting cable with a phono plug and a  $\frac{1}{8}$ -inch plug (such as Cat. No. 42-2461).

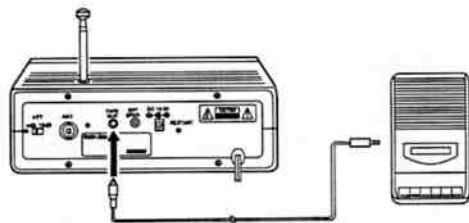

1. Insert the connecting cable's phono plug into the **TAPE OUT** jack on the back of the scanner.
2. Connect the other end of the connecting cable to your tape recorder's microphone jack.

Follow the instructions provided with your tape recorder to record transmissions while the scanner is on.

# UNDERSTANDING YOUR SCANNER

## A LOOK AT THE KEYBOARD

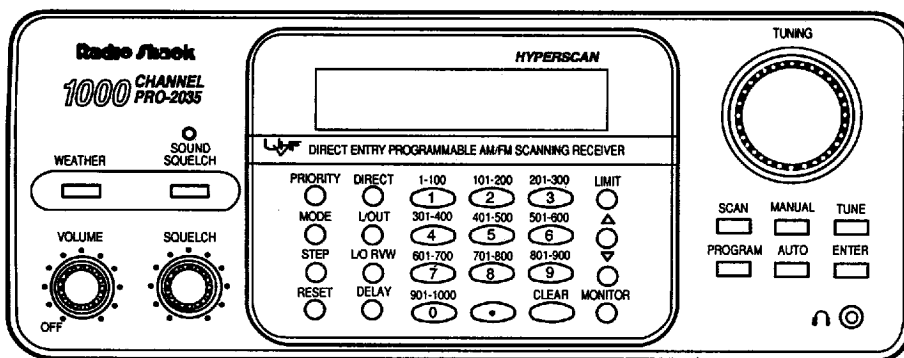

A quick glance at this section should help you understand each key's function.

**WEATHER** — scans through the ten preprogrammed weather channels.

**SOUND SQUELCH** — sets the scanner to continue to scan if it stops on a carrier signal with no voice or other sound.

**OFF/VOLUME** — turns the scanner on or off and adjusts the volume.

**SQUELCH** — adjusts the scanner's squelch.

**PRIORITY** — sets and turns on and off priority for a particular channel.

**DIRECT** — starts a direct frequency search.

**MODE** — changes the band mode (AM, NFM, or WFM).

**L/OUT** — lets you lock out selected channels.

**STEP** — changes the frequency step (5, 12.5, or 50 kHz).

**L/O RVW** — lets you review locked-out channels.

**RESET** — resets the default band mode and frequency step.

**DELAY** — programs a 2-second delay for the selected mode.

**Number Keys** — each key has a single-digit label and a range of numbers. Use the digits on the keys to enter the numbers for a channel or a frequency. Use the range of numbers above the key (201-300, for example) to select the channels in a channel-storage bank. See "Understanding Banks."

• — enters the decimal point when you enter a frequency.

**CLEAR** — clears an incorrect entry.

**LIMIT** — sets the channel or frequency range you want to search.

▲ and ▼ — searches up or down from the currently displayed frequency.

**MONITOR** — accesses the 100 monitor memories.

**TUNING Knob** — turn to tune through channels or frequencies.

**SCAN** — scans through the channels.

**MANUAL** — stops scanning to let you directly enter a channel number.

**TUNE** — lets you use the scanner's rotary tuner to tune through frequencies.

**PROGRAM** — programs frequencies into channels.

**AUTO** — lets you automatically program frequencies into channels.

**ENTER** — enters frequencies into channels.

## A LOOK AT THE DISPLAY

The display has indicators that show the scanner's current operating mode. A good look at the display will help you understand your scanner.

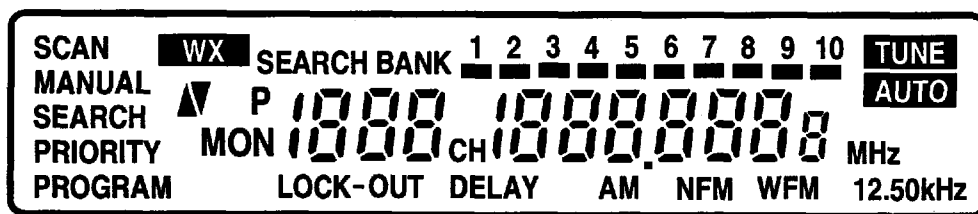

**SCAN** — appears when you scan channels.

**BANK** — appears with numbers (1-10). Numbers with a bar under them show which channel-storage banks are turned on for scanning. See "Understanding Banks."

**SEARCH BANK** — appears with numbers (1-10). Numbers with a bar under them show which search banks are turned on for a limit search.

**TUNE** — appears when you press **TUNE** to use the scanner's rotary tuner.

**MANUAL** — appears when you manually select a channel.

**WX** — appears when you scan the ten preprogrammed weather band channels.

**AUTO** — appears when the scanner automatically stores frequencies in channels.

**SEARCH** — appears during a direct search and a limit search.

▲ and ▼ — appears when the scanner is scanning, when you press ▲ or ▼ while the scanner is in limit or direct search, when you tune through weather channels, or when you store frequencies.

**P** — appears when the scanner is set to the priority channel.

**CH** — appears with a number (1-1000) to show which of the scanner's 1,000 channels it is tuned to.

**MHz** — appears with digits to show which frequency your scanner is currently tuned to.

**PRIORITY** — appears when the priority feature is turned on.

**MON** — appears with a number (1-100) to show which monitor memory you are listening to.

**LOCK-OUT** — appears when you lock out a channel or manually select a locked-out channel.

**DELAY** — appears when scanning stops at a channel you have programmed for a 2-second delay.

**AM** — appears when the scanner scans a frequency set to the AM mode or when you change a frequency to the AM mode. See "Band Mode and Frequency Step."

**NFM** — appears when the scanner scans a frequency set to the narrow-band FM mode, or when you change a frequency to the narrowband FM mode. See "Band Mode and Frequency Step."

**WFM** — appears when the scanner scans a frequency set to the wide-band FM mode, or when you change a frequency to the wideband FM mode. See "Band Mode and Frequency Step."

**kHz** — appears with digits to show which frequency step (5, 12.5, or 50) the scanner is set to.

**PROGRAM** — appears when you press **PROGRAM** while selecting a channel to store a frequency in, or while selecting a search bank.

- d - — appears instead of the channel number during a direct search.

**Error** — appears instead of the correct entry when you make an incorrect entry.

# UNDERSTANDING BANKS

---

---

You can store frequencies into either a permanent memory location called a channel, or a temporary memory location called a monitor memory. You can store up to 1,000 channels and up to 100 monitor memories.

## CHANNEL-STORAGE BANKS

To make it easier to identify and select the channels you want to listen to, channels are divided into 10 channel-storage banks (1-10) of 100 channels each. You can use each channel-storage bank to group frequencies, such as those used by the police department, fire department, ambulance services, and aircraft (see "Guide to the Action Bands").

For example, there might be three or four police departments in your area, each using several different frequencies. Additionally, there might be other law enforcement agencies such as state police, county sheriffs, or SWAT teams that use their own frequencies. You could program all law enforcement frequencies starting with Channel 1 (the first channel in Bank 1), then program the fire department, paramedic, and other public safety frequencies starting with Channel 101 (the first channel in Bank 2).

## MONITOR MEMORIES

The scanner also has 100 monitor memories. Use these memories to temporarily store frequencies while you decide whether to save them into channels. This is handy for quickly storing an active frequency when you are searching through an entire band.

To store a frequency into a monitor memory, you must perform a limit or direct search. See "Searching For and Storing Active Frequencies."

You can select monitor memories either manually or by using the scanner's rotary tuner, but you cannot scan them. See "Using Monitor Memories."



# OPERATION

---

---

## TURNING ON THE SCANNER/SETTING VOLUME AND SQUELCH

1. Turn **SQUELCH** fully counterclockwise.
2. Turn **VOLUME** clockwise until you hear a hissing sound.
3. Turn **SQUELCH** clockwise, then leave it set to a point just after the hissing sound stops.

**Note:** If the scanner picks up unwanted, partial, or very weak transmissions, turn **SQUELCH** clockwise to decrease the scanner's sensitivity to these signals. If you want to listen to a weak or distant station, turn **SQUELCH** counterclockwise.

## TURNING CHANNEL-STORAGE BANKS ON AND OFF

When you turn on the scanner the first time, the scanner scans all ten channel-storage banks. As the scanner scans a bank, the bar under the bank's number flashes.

To turn off banks while scanning, press the bank's number key until the bar under the bank's number disappears. The scanner does not scan any of the stored channels within banks you have turned off.

### Notes:

- You cannot turn off all banks. There must be at least one active bank.
- You can manually select any channel in a bank, even if the bank is turned off.

To turn on banks while scanning, press the bank's number key until a bar appears under the bank's number.

## SCANNING THE CHANNELS

To begin scanning the channels or to start scanning again after monitoring a specific channel, press **SCAN**. The scanner scans through all non-locked channels in the active banks (see "Locking Out Channels").

Your scanner scans either up or down through the channels in the activated banks. To change the scanning direction, either press **▲** or **▼**, or rotate **TUNING** counterclockwise to scan down, or clockwise to scan up.

## USING THE ROTARY TUNER

The scanner's rotary tuner lets you quickly select channels and frequencies.

**Note:** If you turn **TUNING** too slowly, the scanner might accidentally change the search or scan direction. If you turn **TUNING** too quickly, the scanner might not display the frequency or channel you expected.

### Tuning Channel Numbers

To tune to higher channel numbers, turn **TUNING** clockwise one notch at a time. To tune to lower channel numbers, turn **TUNING** counterclockwise one notch at a time.

### Tuning Frequencies

**Note:** You cannot use the rotary tuner to tune to frequencies while the scanner is scanning the priority channel.

1. When the scanner stops on a frequency while scanning, press **MANUAL. MANUAL** appears.
2. Press **TUNE. MANUAL**, the frequency number, and **TUNE** appear.

To tune to higher frequencies, turn **TUNING** clockwise one notch at a time. To tune to lower frequencies, turn **TUNING** counterclockwise one notch at a time.

## USING MONITOR MEMORIES

Monitor memories are temporary storage areas where you can store up to 100 frequencies while you decide whether to save them into channels. You can manually select monitor memories, but you cannot scan them.

You can store frequencies you find during a limit or direct search into monitor memories by pressing **MONITOR** when the desired frequency appears on the display. The channel number to the right of **MON** indicates the current monitor memory.

To listen to a monitor memory, press **MANUAL**, then press **MONITOR**. The current monitor memory appears. To select other monitor memories, either:

- Turn **TUNING** one click to select each monitor memory.
- Use the number keys to enter the monitor memory's channel number, then press **MONITOR**.

Both **MON** and the frequency stored in the monitor memory are displayed.

## SEARCHING FOR AND STORING ACTIVE FREQUENCIES

You can store frequencies into channels using any of the following methods:

- Manual storage
- Auto storage
- Limit search (within a range of frequencies you select)
- Direct search (any range of frequencies before or after a frequency you select)
- Moving a frequency from a monitor memory

Good references for active frequencies are Radio Shack's "Police Call Radio Guide Including Fire and Emergency Services," "Aeronautical Frequency Directory," and "Maritime Frequency Directory." We update these directories every year, so be sure to get a current copy. See also "Guide to the Action Bands" in this manual.

If you do not have a reference to frequencies in your area, follow the steps in "Automatically Storing Frequencies" or "Limit Search" to search for transmissions.

## Manually Storing Frequencies

If you know a frequency you want to store, you can store it manually.

1. Press **PROGRAM**. **PROGRAM** appears.
2. To select the channel where you want to store the frequency, either turn **TUNING** until the channel number appears, or use the number keys to enter the channel number. Then press **PROGRAM**.
3. Using the number keys, enter the frequency you want to store into that channel.
4. Press **ENTER** to store the frequency.

### Notes:

- If you entered an invalid frequency in Step 3, the scanner beeps and displays the channel number and **Error**. Simply repeat Steps 3 and 4.
  - Your scanner automatically rounds the entered frequency down to the closest valid frequency. For example, if you try to enter a frequency of 151.473, your scanner accepts it as 151.470.
5. Repeat Steps 2-4 to store more frequencies into channels.

## Automatically Storing Frequencies

Your scanner can automatically store active frequencies into empty channels in the banks you specify.

1. Press **AUTO**. **AUTO** appears.
2. Using the number keys, select the numbers of the banks where you want to store frequencies.

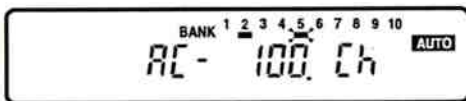

### Notes:

- To select bank 10, press 0.
- If you select a bank that does not contain any empty channels, a bar flashes under the bank number, and **-FULL-** and **AUTO** appear. To enter new frequencies into this bank, you must delete one or more frequencies stored in it, then repeat Step 2. See "Deleting Frequencies."
- If you select a bank that contains an empty channel, a bar flashes under the bank number, and **AC-**, the number of vacant channels in the bank, **Ch**, and **AUTO** appear.
- If you do not want to select the bank, press the bank's number again.

- If you select more than one bank and want to review your selections, turn **TUNING** one click for each selected bank. As you turn **TUNING**, a bar flashes under each selected bank number.

3. Press **LIMIT. Lo** appears.
4. Use the number keys to enter the lower limit of the frequency range you want to search, then press **ENTER**.

### Notes:

- If you enter an invalid frequency in Step 4 or 6, the scanner displays **Error**. Simply repeat the step.
  - If you enter any frequency in a range from 823.950 to 823.995 MHz for a lower limit in this step, the scanner displays and uses 823.950 as the lower limit after you press **ENTER**. If you enter any frequency in a range from 868.950 to 868.995 MHz for a lower limit in this step, the scanner displays and uses 868.950 as the lower limit after you press **ENTER**.
5. Press **LIMIT. Hi** appears.
  6. Use the number keys to enter the upper limit of the frequency range you want to search, then press **ENTER**.

**Note:** If you enter any frequency in a range from 849.005 to 849.050 MHz for an upper limit in this step,

the scanner displays and uses 849.050 as the upper limit after you press **ENTER**. If you enter any frequency in a range from 894.005 to 894.050 MHz for an upper limit in this step, the scanner displays and uses 894.050 as the upper limit after you press **ENTER**.

7. Press **▲** to search from the lower to the upper limit, or **▼** to search from the upper to the lower limit. **AUTO** and the bar under the selected bank number flash on the display.

When the scanner finds an active frequency, it stores the frequency in the displayed channel, then continues searching for more active frequencies and storing them in any subsequent empty channels. When the scanner fills all channels within the selected banks, the scanner beeps rapidly and displays the number of the last channel where a frequency was stored.

**Note:** During auto store, you can manually change the frequency step or band mode. See "Changing/Resetting the Frequency Step" or "Changing/Resetting the Band Mode."

8. To interrupt auto store, press **AUTO**. The scanner displays the last channel number where a frequency was stored. To continue auto store, press **▲** or **▼**.
9. To stop auto store, press **MANUAL**. **MANUAL** appears.

## Limit Search

You can search for transmissions within a range of frequencies you select, called the limit search range. You can set and store up to ten limit search ranges into search banks (1-10).

### Notes:

- You can use the scanner's delay feature while using limit search. See "Delay."
- When the scanner searches for frequencies within a limit search range, you can store frequencies you hear during the search into monitor memories.

Follow these steps to set and store limit search ranges and search them for active frequencies.

1. Press **PROGRAM**. **PROGRAM** appears.
2. Using the number keys, select the number for the search bank where you want to store a limit search range.

**Note:** To select bank 10, press 0.

3. Press **LIMIT SEARCH BANK** and **Lo** appear, and a bar flashes under the selected search bank's number. If you already entered limit search ranges in other search banks, a bar appears under each search bank's number.

4. Use the number keys to enter the lower limit of the frequency range you want to search, then press **ENTER**.

**Notes:**

- If you enter an invalid frequency in Step 4 or 6, the scanner displays **Error**. Simply repeat the step.
- If you enter any frequency in a range from 823.950 to 823.995 MHz for a lower limit in this step, the scanner displays and uses 823.950 as the lower limit after you press **ENTER**. If you enter any frequency in a range from 868.950 to 868.995 MHz for a lower limit in this step, the scanner displays and uses 868.950 as the lower limit after you press **ENTER**.

5. Press **LIMIT. SEARCH BANK** and **Hi** appear.

6. Use the number keys to enter the upper limit of the frequency range you want to search, then press **ENTER**.

**Notes:**

- If you create more than one search bank and you want to review your limit search ranges, turn **TUNING** one click for each selected search bank. As you turn **TUNING**, a bar flashes under the active search bank number, and either **Lo** or **Hi** is displayed. Press **LIMIT** to review the high and low limits of the frequency ranges for the selected search bank.

- If you enter any frequency in a range from 849.005 to 849.050 MHz for an upper limit in this step, the scanner displays and uses 849.050 as the upper limit after you press **ENTER**. If you enter any frequency in a range from 894.005 to 894.050 MHz for an upper limit in this step, the scanner displays and uses 894.050 as the upper limit after you press **ENTER**.

7. Press **▲** to search from the lower to the upper limit, or **▼** to search from the upper to the lower limit. As the scanner searches, it displays **SEARCH**, and the bar under the selected search bank number flashes.

When the scanner finds an active frequency, it stops searching. To save the frequency into a monitor memory, press **MONITOR. MON** and the current monitor channel number appear on the display. Press **▲** or **▼** again to continue searching for additional active frequencies.

**Notes:**

- If you set the limit search range to a range that is narrower than the step frequency, the scanner beeps and displays **-PASS-** when you press **▲** or **▼**. To correct this problem, either press **STEP** to change the step frequency or enter a wider frequency range in Steps 4 and 6.

- As the scanner searches, you can also use **TUNING** to search through frequencies manually by pressing **TUNE**, then turning the **TUNING** knob. Press **TUNE** again to continue the limit search.
- During the limit search, you can manually change the frequency step or band mode. See "Changing/Resetting the Frequency Step" or "Changing/Resetting the Band Mode."

## Direct Search

You can search up or down from the currently displayed frequency and store frequencies you hear during the search into monitor memories.

**Note:** You can use the scanner's delay feature while using direct search. See "Delay."

1. Press **MANUAL** or **PROGRAM**.
2. Use the number keys to enter the frequency you want to start the search from. Or, use the number keys to enter the channel number containing the starting frequency and press **MANUAL** or **PROGRAM** again.
3. Press **DIRECT SEARCH**, **-d-**, and the starting frequency appear on the display.

4. Press **▲** or **▼** to search up or down from the selected frequency.

When the scanner finds an active frequency, it stops searching. To save the frequency into a monitor memory, press **MONITOR. MON** and the current monitor channel number appear on the display. Press **▲** or **▼** again to continue searching for more active frequencies.

### Notes:

- As the scanner searches, you can also use the **TUNING** knob to search through frequencies manually by pressing **TUNE**, then turning the **TUNING** knob. Press **TUNE** again to continue the direct search.
- During direct search, you can manually change the frequency step or band mode. See "Changing/Resetting the Frequency Step" or "Changing/Resetting the Band Mode."

## MOVING FREQUENCIES

### Moving a Frequency from a Monitor Memory to a Channel

1. Press **PROGRAM**.
2. Use the number keys to enter the channel number where you want to store the monitor frequency, then press **PROGRAM**.

3. Press **MONITOR**. **MON** flashes. Use the number keys to enter the monitor memory's channel number, then press **MONITOR**. Or, turn **TUNING** to select the channel number.

**MON** flashes and the monitor memory's channel number and frequency appear.

4. Press **ENTER**. The scanner stores the frequency in the selected channel number.

To move the next frequency to the next channel, turn **TUNING** to select the next channel and repeat Steps 3 and 4.

## Moving Frequencies from Monitor Memories to Banks

Your scanner can move frequencies stored in monitor memories into banks you specify.

1. Press **AUTO**. **AUTO** appears.
2. Using the number keys, select the bank numbers where you want to store the frequencies from the monitor memories.

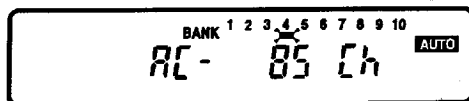

### Notes:

- To select bank 10, press 0.
- If you select a bank that does not contain any empty channels, a bar flashes under the bank number, and **-FULL-** and **AUTO**

appear. To store new frequencies into this bank, you must delete one or more frequencies stored in it, then repeat Step 2. See "Deleting Frequencies."

- If you select a bank that contains an empty channel, a bar flashes under the bank number, and **AC-**, the number of vacant channels in the bank, **Ch**, and **AUTO** appear.
  - If you do not want to select the bank, press the bank's number again.
  - If you select more than one bank and want to review your selections, turn the **TUNING** knob one click for each selected bank. As you turn the **TUNING** knob, a bar flashes under each selected bank number.
3. Press and hold down **ENTER**, then press **MONITOR**. A bar flashes under the bank number, and **AC-**, the number of vacant channels in the bank, **Ch**, and **AUTO** appear.



## Moving Frequencies Within Banks

You can move all stored frequencies within a bank you select from higher channels to lower, empty channels. This helps you group all of the frequencies you stored within a bank into consecutive channels. For example, if you stored frequencies in channels 1 through 25, left channels 26 through 30 empty, then stored more frequencies in channels 30 through 40, the scanner can move all the frequencies together into channels 1 through 35.

1. Press **AUTO**. **AUTO** appears.
2. Using the number keys, select the bank's number.
3. Press and hold down **ENTER**, then press **RESET**. The scanner automatically moves all frequencies in channels within the bank to the lowest available channels within the bank.

## Moving Frequencies from Banks to Monitor Memory

1. Press **AUTO**. **AUTO** appears.
2. Using the number keys, select the bank's number.
3. Press and hold down **ENTER**, then press **.** (decimal point). The scanner automatically moves all frequencies in channels within the bank to monitor memories.

## DELETING FREQUENCIES

### Deleting a Frequency from a Channel or Monitor Memory

1. Press **PROGRAM**.
2. Use the number keys to enter the channel number or monitor memory channel containing the frequency you want to delete.
3. If you are deleting the frequency in a channel, press **PROGRAM**.  
If you are deleting the frequency in a monitor memory, press **MONITOR**.
4. Press **0**, then press **ENTER**. The frequency is deleted from the channel.

**Note:** To delete all frequencies in all banks at the same time, you must reset the scanner. See "Restarting/Resetting the Scanner."

---

---

## Deleting Frequencies from Locked-Out Channels within a Bank

You can delete the frequencies in all locked-out channels within a bank you select. This lets you delete all the old or uninteresting frequencies in channels you have locked out.

**Note:** For more information about using lock out, see "Locking Out Channels."

1. Press **AUTO**. **AUTO** appears.
2. Using the number keys, select the bank's number.
3. Press and hold down **ENTER**, then press **L/OUT**.

## Deleting All Frequencies from Channels within a Bank

1. Press **AUTO**. **AUTO** appears.
2. Using the number keys, select the bank's number.
3. Press and hold down **ENTER**, then press **CLEAR**.

# SPECIAL FEATURES

---

## DELAY

Many agencies use a two-way radio system that might have a pause of several seconds between a query and a reply. Your scanner's delay feature lets it wait for 2 seconds after each transmission on a channel or frequency while scanning or searching.

To program a 2-second delay for a channel while scanning, manually select the channel and press **DELAY** until **DELAY** appears. When your scanner stops on the channel, it waits for 2 seconds after each transmission on that channel before it resumes scanning.

To program a 2-second delay for any active frequency while searching, press **DELAY** until **DELAY** appears. When your scanner stops on a transmission, it waits for 2 seconds after each transmission on that frequency before it resumes searching.

## USING THE ATT SWITCH

To reduce interference or noise caused by signals from a strong local broadcaster, you can reduce the scanner's sensitivity to signals by setting the **ATT** (attenuate) switch on the back of the scanner.

Switch **ATT** to **10dB** to reduce the scanner's sensitivity, or **0dB** to increase the scanner's sensitivity.

**Note:** If you switch **ATT** to **10dB**, your scanner might not receive weak signals.

## USING THE SOUND SQUELCH SWITCH

You can have the scanner skip frequencies that broadcast only a carrier signal (without an accompanying modulated signal) by setting the **SOUND SQUELCH** switch on the front of the scanner. When **SOUND SQUELCH** is turned on, the scanner continues scanning if it does not detect a modulated signal on a frequency within 0.5 seconds.

### Notes:

- This feature works only while the scanner is scanning, searching, or monitoring the priority channel.
- The sound squelch feature might not work properly if the monitored frequency contains a transmission with a low modulated signal.

To set sound squelch, press **SOUND SQUELCH** until the scanner beeps and the **SOUND SQUELCH** indicator turns on. To turn off sound squelch, press **SOUND SQUELCH** again.

If the scanner receives a frequency that broadcasts both a carrier and a modulated signal, it stops scanning and monitors the frequency. If the modulated signal stops being broadcast on the frequency, the scanner stays on the frequency for 5 seconds, then resumes scanning. If the carrier signal stops being broadcast on the frequency, the scanner resumes scanning immediately unless **DELAY** is set.

## LOCKING OUT CHANNELS

You can scan existing channels faster by locking out channels that have a continuous transmission, such as a weather channel.

To lock out a channel while scanning, press **L/OUT** when the scanner stops on the channel. To lock out a channel manually, manually select the channel and press **L/OUT** until **LOCK-OUT** shows on the display.

To remove the lockout from a channel, manually select the channel and press **L/OUT** until **LOCK-OUT** disappears from the display.

### Notes:

- You can delete the frequencies stored in locked-out channels within a bank. See "Deleting Frequencies from Locked-Out Channels within a Bank."
- You can still manually select locked-out channels.
- You cannot lock out all channels. There must be at least one active channel in each bank.

## Reviewing Locked-Out Channels

To review which channels are locked out, press **MANUAL**, then repeatedly press **L/O RVW**. As you press **L/O RVW**, the scanner displays all locked-out channels.

## PRIORITY

With the priority feature, you can scan through programmed channels and still not miss an important or interesting call on a specific channel. You can program one stored channel as a priority channel.

**Note:** Before you first program your scanner, it automatically designates Channel 1 in Bank 1 as the priority channel.

Follow these steps to program a channel as the priority channel.

1. Press **PROGRAM**.
2. Use the number keys to enter the channel number you want to program as the priority channel, then press **PRIORITY**. **P** appears on the display to the left of the channel number.

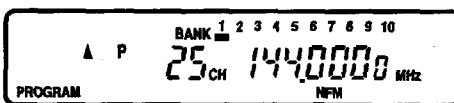

To turn on the priority feature, press **PRIORITY** during scanning. The scanner checks the priority channel every 2 seconds. It stays on the channel if there is activity, and **PRIORITY** appears.

To turn off the priority feature, press **PRIORITY**. **PRIORITY** disappears from the display.

## MANUALLY SELECTING A CHANNEL

You can continuously monitor a specific channel without scanning. This is useful if you hear an emergency broadcast on a channel and do not want to miss any details (even though there might be periods of silence) or if you want to monitor a locked-out channel.

Follow these steps to manually select a channel.

1. Press **MANUAL**.
2. Use the number keys to enter the channel number you want to hear, then press **MANUAL**.

### Notes:

- If your scanner is scanning and stops at the channel you want, you do not have to press **MANUAL** again in Step 2.
- If you repeatedly press **MANUAL**, the scanner steps through the channels. To change the step direction, press either **▲** or **▼** before you press **MANUAL**.

## LISTENING TO THE WEATHER BAND

The FCC (Federal Communications Commission) has allocated 11 channels for use by the National Oceanic and Atmospheric Administration (NOAA). NOAA broadcasts your local forecast and regional weather information on one or more of these channels. We have preprogrammed your scanner with ten of the U.S. frequencies available to NOAA.

To scan the preprogrammed weather channels, press **WEATHER**, then press **▲** or **▼**.

To manually tune through the preprogrammed weather channels, repeatedly press **WEATHER** or turn **TUNING**.

**Note:** For a list of all 11 national weather frequencies, see "National Weather Frequencies."

## BAND MODE AND FREQUENCY STEP

The scanner scans in the following band modes:

- **AM** (amplitude modulation) — used in aircraft bands and Citizen's Band.
- **NFM** (narrowband frequency modulation) — used in action bands such as police, fire, ambulance, Amateur Radio, etc.
- **WFM** (wideband frequency modulation) — used in commercial FM broadcasts and television sound.

This table shows the preset band modes and frequency steps your scanner uses for each frequency range.

Frequency Range (MHz)	Band Mode	Frequency Step (kHz)
25.000 – 29.995	AM	5
30.000 – 87.495	NFM	5
87.500 – 107.950	WFM	50
108.000 – 136.9875	AM	12.5
137.000 – 224.995	NFM	5
225.000 – 400.000	AM	12.5
400.0125 – 520.000	NFM	12.5
760.000 – 1300.000	NFM	12.5

If you scan some of the 225-400 MHz and TV audio bands, you might have to manually change the band mode or frequency step.

## Changing/Resetting the Band Mode

To change the displayed band mode while a frequency appears, press **MODE** until the desired band mode appears. The band mode flashes anytime it is different from the preset band mode. To reset the displayed band mode to its preset, press **RESET**.

### Notes:

- You cannot change the band mode unless it appears on the display.
- Keep in mind that improperly changing the band mode can cause poor reception. For example, the sound is distorted when you listen to an FM broadcast or TV audio in the NFM mode or to a police broadcast in the WFM mode.

is set to NFM, you might miss frequencies between the 50 kHz steps.

## Changing/Resetting the Frequency Step

The scanner scans at a preset frequency step (5, 12.5 or 50 kHz) for each frequency range. However, if you scan some of the 225-400 MHz and TV audio bands, you might have to manually change the frequency step.

You can change the displayed frequency step while searching for frequencies or automatically storing frequencies.

Follow these steps to change the displayed frequency step.

1. Display the frequency step or frequency range which uses the frequency step.
2. Press **STEP** until the desired frequency step appears.

The frequency step flashes anytime it is different from the preset frequency step.

To change a displayed frequency step back to its preset value, press **RESET**.

### Notes:

- You cannot change the frequency step unless it appears on the display.
- Keep in mind that improperly changing the frequency step can cause you to miss stations while scanning. For example, if you use a 50 kHz frequency step to search for broadcasts, and the band mode

# A GENERAL GUIDE TO SCANNING

Reception of the frequencies covered by your scanner is mainly "line-of-sight." That means you usually cannot hear stations that are beyond the horizon.

During the summer months, you might be able to hear stations in the 30-50 MHz range located several hundred or even thousands of miles away. This is because of summer atmospheric conditions. This type of reception is unpredictable but often very interesting!

## GUIDE TO FREQUENCIES

### National Weather Frequencies

161.650 MHz	162.425 MHz	162.475 MHz	162.550 MHz
161.775 MHz	162.440 MHz	162.500 MHz	163.275 MHz
162.400 MHz	162.450 MHz	162.525 MHz	

### Ham Radio Frequencies

Ham radio operators often broadcast emergency information when other means of communication break down.

The following chart shows the voice frequencies that you can monitor:

Wavelength (meters)	Voice (MHz)	
	10 - meter	28.300
6 - meter	50.100	54.000
2 - meter	144.100	148.000
1 1/4 - meter	222.000	225.000
70 - cm	420.000	450.000
33 - cm	902.000	928.000
23 - cm	1240.000	1300.000



# Citizens Band Frequencies

Channel	Frequency (MHz)	Channel	Frequency (MHz)
1	26.965	21	27.215
2	26.975	22	27.225
3	26.985	23	27.255
4	27.005	24	27.235
5	27.015	25	27.245
6	27.025	26	27.265
7	27.035	27	27.275
8	27.055	28	27.285
9	27.065	29	27.295
10	27.075	30	27.305
11	27.085	31	27.315
12	27.105	32	27.325
13	27.115	33	27.335
14	27.125	34	27.345
15	27.135	35	27.355
16	27.155	36	27.365
17	27.165	37	27.375
18	27.175	38	27.385
19	27.185	39	27.395
20	27.205	40	27.405

## Birdie Frequencies

Birdies are frequencies your scanner uses when it operates. These operating frequencies might interfere with broadcasts on the same frequencies. If you program one of these frequencies, you hear only noise on that frequency.

If the interference is not severe, you might be able to turn **SQUELCH** clockwise to cut out the birdie. These are the most common birdies to watch for:

25.800 MHz	27.640 MHz	28.125 MHz	30.405 MHz	32.145 MHz
33.170 MHz	36.160 MHz	40.180 MHz	41.460 MHz	44.195 MHz
48.045 MHz	48.215 MHz	52.235 MHz	54.750 MHz	56.345 MHz
64.275 MHz	68.305 MHz	72.320 MHz	76.340 MHz	80.200 MHz
80.360 MHz	80.600 MHz	84.360 MHz	108.4825 MHz	112.500 MHz
116.525 MHz	120.5375 MHz	123.375 MHz	144.135 MHz	144.645 MHz
152.655 MHz	155.625 MHz	184.830 MHz	192.860 MHz	200.900 MHz
212.950 MHz	220.950 MHz	224.960 MHz	225.000 MHz	233.050 MHz
237.0125 MHz	241.075 MHz	249.1125 MHz	265.1875 MHz	299.5625 MHz
311.400 MHz	343.600 MHz	362.000 MHz	387.000 MHz	412.000 MHz
421.800 MHz	425.9125 MHz	466.250 MHz	467.250 MHz	490.375 MHz
491.375 MHz	772.200 MHz	773.400 MHz	774.600 MHz	820.400 MHz
821.600 MHz	822.800 MHz	906.3125 MHz	907.5625 MHz	908.8125 MHz
978.500 MHz	1004.250 MHz	1008.600 MHz	1013.000 MHz	1022.800 MHz
1025.6875 MHz	1055.125 MHz	1068.4375 MHz	1074.600 MHz	1090.400 MHz
1113.000 MHz	1117.6875 MHz	1152.750 MHz	1164.625 MHz	1166.200 MHz
1182.4375 MHz	1186.800 MHz	1188.375 MHz	1196.125 MHz	1200.250 MHz
1227.000 MHz	1227.500 MHz	1251.875 MHz	1264.9375 MHz	1271.950 MHz
1281.250 MHz				

**Note:** Depending on the temperature of some of the scanner's components, you might hear birdies on frequencies slightly above or below the frequencies listed here.

# GUIDE TO THE ACTION BANDS

## United States Broadcast Bands

In the United States, there are several broadcast bands. The standard AM and FM bands are probably the most well known, and you can monitor the FM band on your scanner. There are also four television audio broadcast bands — the lower three transmit on the VHF band and the fourth transmits on the UHF band. You can monitor all three of the VHF bands and the UHF band.

Frequency Range	Allocation
54.0 – 72.00 MHz	VHF Television
76.0 – 88.00 MHz	VHF Television
88.0 – 108.00 MHz	Standard FM
174.0 – 216.00 MHz	VHF Television
470.0 – 805.75 MHz	UHF Television

## International Broadcast Bands

Several shortwave bands are allocated for international broadcasting because of the nature of propagation of high frequencies. The bands are sometimes identified according to the approximate wavelength of the signals in meters.

Frequency Range (in MHz)	Band (in meters)
25.60 – 26.10	11

## Typical Band Usage

### HF Band (3.00–30.0 MHz)

Mid Range, Citizens Band.....	(25.00 – 28.00 MHz)
10-Meter Amateur .....	(28.00 – 29.70 MHz)

### VHF Band (30.00–300.0 MHz)

Low Range .....	(29.70 – 50.00 MHz)
6-Meter Amateur .....	(50.00 – 54.00 MHz)
FM-TV Audio Broadcast, Wide Band .....	(54.00 – 72.00 MHz)
Land Mobile Service.....	(72.00 – 76.00 MHz)
FM-TV Audio Broadcast, Wide Band .....	(76.00 – 88.00 MHz)
FM Radio Broadcast, Wide Band.....	(88.00 – 108.00 MHz)
Aircraft.....	(108.00 – 136.98 MHz)
U.S. Government .....	(137.00 – 144.00 MHz)
2-Meter Amateur .....	(144.00 – 148.00 MHz)
High Range .....	(148.00 – 174.00 MHz)
FM-TV Audio Broadcast, Wide Band .....	(174.00 – 216.00 MHz)
New Mobile Narrow Band .....	(220.00 – 222.00 MHz)
1 <sup>1</sup> / <sub>4</sub> -Meter Amateur .....	(222.00 – 225.00 MHz)
Military Aircraft.....	(225.00 – 287.80 MHz)

### UHF Band (300.00 MHz–3.0 GHz)

Military Aircraft.....	(311.00 – 384.00 MHz)
U. S. Government .....	(406.00 – 450.00 MHz)
70-Centimeter Amateur.....	(420.00 – 450.00 MHz)
Low Range .....	(450.00 – 470.00 MHz)
FM-TV Audio Broadcast, Wide Band .....	(470.00 – 806.00 MHz)
Public Service .....	(806.00 – 823.98 MHz)
Conventional Systems .....	(851.00 – 856.00 MHz)
Conventional/Trunked Systems .....	(856.00 – 861.00 MHz)
Trunked Systems .....	(861.00 – 866.00 MHz)
Public Safety .....	(866.00 – 869.00 MHz)
High Range .....	(894.01 – 902.00 MHz)
33-Centimeter Amateur .....	(902.00 – 928.00 MHz)
Private Trunked .....	(935.00 – 940.00 MHz)
General Trunked .....	(940.00 – 941.00 MHz)
Fixed Services.....	(941.00 – 944.00 MHz)
Studio-to-Transmitter Broadcast Links.....	(944.00 – 952.00 MHz)
Private Fixed Services, Paging .....	(952.00 – 960.00 MHz)
Aeronautical Navigation .....	(960.00 – 1240.00 MHz)
23-Centimeter Amateur .....	(1240.00 – 1300.00 MHz)

## Primary Usage

As a general rule, most of the radio activity is concentrated on the following frequencies:

### VHF Band

Activities	Frequencies
Government, Police, and Fire Emergency Services	153.785 – 155.980 MHz 158.730 – 159.460 MHz
Railroad	160.000 – 161.900 MHz

### UHF Band

Activities	Frequencies
Land-Mobile Paired Frequencies	450.000 – 470.000 MHz
Base Stations	451.025 – 454.950 MHz
Mobile Units	456.025 – 459.950 MHz
Relay Repeater Units	460.025 – 464.975 MHz
Remote Control Stations	465.025 – 469.975 MHz

**Note:** Remote control stations and mobile units operate at 5 MHz higher than their associated base stations and relay repeater units.

## Specified Intervals

Frequencies in different bands are accessible only at specific intervals. For example:

Band Type	Specified Interval
VHF, HAM, and Government	5.0 kHz steps
All Others	12.5 kHz steps
Aircraft	25.0 kHz steps

**Note:** Your scanner automatically rounds the entered frequency down to the closest valid frequency. For example, if you try to enter a frequency of 151.473, your scanner accepts it as 151.470.

## BAND ALLOCATION

To help decide which frequency ranges to scan, use the following listing of the typical services that use the frequencies your scanner receives. These frequencies are subject to change, and might vary from area to area. For a more complete listing, refer to the "Police Call Radio Guide including Fire and Emergency Services," available at your local Radio Shack store.

### Abbreviations

AIR..... Aircraft	MED..... Emergency/Medical Services
BIFC..... Boise (ID) Interagency Fire Cache	MIL..... U.S. Military
BUS..... Business	MOV..... Motion Picture/Video Industry
CAP..... Civil Air Patrol	NEW..... New Mobile Narrow
CB..... Citizens Band	NEWS..... Relay Press (Newspaper reporters)
CCA..... Common Carrier	OIL..... Oil/Petroleum Industry
CSB..... Conventional Systems	PFSP..... Private Fixed Services/Paging
CTSB..... Conventional/Trunked Systems	POL..... Police Department
FIRE..... Fire Department	PUB..... Public Services
HAM..... Amateur (Ham) Radio	(Public Safety, Local Government, Forestry Conservation)
GOVT..... Federal Government	PSB..... Public Safety
GMR..... General Mobile Radio	PTR..... Private Trunked
GTR..... General Trunked	ROAD..... Road & Highway Maintenance
IND..... Industrial Services	RTV..... Radio/TV Remote Broadcast Pickup
(Manufacturing, Construction, Farming, Forest Products)	TAXI..... Taxi Services
MAR..... Military Amateur Radio	TELB..... Mobile Telephone
MARI..... Maritime Limited Coast	(Aircraft, Radio Common Carrier, Landline companies)
(Coast Guard, Marine telephone, Shipboard Radio, Private stations)	TELC..... Cordless Phones
MARS..... Military Affiliate Radio System	TELM..... Telephone Maintenance
	TOW..... Tow Trucks

TRAN.....Transportation Services  
 (Trucks, Tow Trucks, Buses, Railroad, Other)  
 TSB.....Trunked Systems  
 TVn.....FM-TV Audio Broadcast  
 USXX.....Government Classified  
 UTIL.....Power & Water Utilities  
 WTHR.....Weather

**High Frequency (HF) - (3 MHz-30 MHz)**

High Band - (25.00 - 27.63 MHz)  
 25.020-25.320.....IND  
 25.870-26.470.....RTV  
 26.62.....CAP  
 26.965-27.405.....CB  
 27.430-27.630.....BUS

10-Meter Amateur Band - (28.0-29.7 MHz)  
 28.000-29.700.....HAM

**Very High Frequency (VHF) - (30 MHz - 300 MHz)**

Low Band - (29.7-50 MHz - in 5 kHz steps)  
 29.700-29.790.....IND  
 29.900-30.550.....GOVT, MIL  
 30.580-31.980.....IND, PUB  
 32.000-32.990.....GOVT, MIL  
 33.020-33.980.....US, IND, PUB  
 34.010-34.990.....GOVT, MIL  
 35.020-35.980.....BUS, PUB, IND, TELM  
 36.000-36.230.....GOVT, MIL  
 36.250.....Oil Spill Clean up  
 36.270-36.990.....GOVT, MIL  
 37.020-37.980.....PUB, IND  
 38.000-39.000.....GOVT, MIL  
 39.020-39.980.....PUB  
 40.000-42.000.....GOVT, MIL, MARI  
 42.020-42.940.....POL  
 42.960-43.180.....IND  
 43.220-43.680.....TELM, IND, PUB  
 43.700-44.600.....TRAN  
 44.620-46.580.....POL, PUB  
 46.600-46.990.....GOVT, TELC  
 47.020-47.400.....PUB  
 47.420.....American Red Cross  
 47.440-49.580.....IND, PUB  
 49.610-49.990.....MIL, TELC

6-Meter Amateur Band - (50-54 MHz)  
 50.00-54.00.....HAM

FM-TV Audio Broadcast, Wide Band - (54-72 MHz)  
 59.750.....TV2  
 65.750.....TV3  
 71.750.....TV4

**Land Mobile Service Band (72-76 MHz)**

FM-TV Audio Broadcast, Wide Band (76-88 MHz)  
 81.750.....TV5  
 87.750.....TV6

**FM Radio Broadcast, Wide Band (88-108 MHz)**

Aircraft Band (108-136 MHz)  
 108.000-121.490.....AIR  
 121.500.....AIR Emergency  
 121.510-136.000.....AIR

U.S. Government Band (138-144 MHz)  
 137.000-144.000.....GOVT, MIL

2-Meter Amateur Band (144-148 MHz)  
 144.000-148.000.....HAM

VHF-Hi BAND (148-174 MHz)  
 148.050-150.345.....CAP, MAR, MIL  
 150.775-150.790.....MED  
 150.815-150.965.....TOW  
 150.980.....Oil Spill Clean up  
 150.995-151.130.....ROAD  
 151.145-151.475.....POL  
 151.490-151.955.....IND, BUS  
 151.985.....TELM  
 152.0075.....MED  
 152.030-152.240.....TELB  
 152.270-152.465.....IND, TAXI  
 152.480.....BUS  
 152.510-152.840.....TELB  
 152.870-153.020.....IND, MOV  
 153.035-153.725.....IND, OIL, UTIL  
 153.740-154.445.....PUB, FIRE  
 154.490-154.570.....IND, BUS  
 154.585.....Oil Spill Clean up  
 154.600-154.625.....BUS  
 154.655-156.240.....MED, ROAD, POL, PUB  
 156.255.....OIL  
 156.275-157.425.....MARI

157.450.....MED  
 157.470-157.515.....TOW  
 157.530-157.725.....IND, TAXI  
 157.740.....BUS  
 157.770-158.100.....TELB  
 158.130-158.460.....BUS, IND, OIL, TELM, UTIL  
 158.490-158.700.....TELB  
 158.730-159.465.....POL, PUB, ROAD  
 159.480.....OIL  
 159.495-161.565.....TRAN  
 161.580.....OIL  
 161.600-162.000.....MARI, RTV  
 162.0125-162.35.....GOVT, MIL, USXX  
 162.400-162.550.....WTHR  
 162.5625-162.6375.....GOVT, MIL, USXX  
 162.6625.....MED  
 162.6875-163.225.....GOVT, MIL, USXX  
 163.250.....MED  
 163.275-166.225.....GOVT, MIL, USXX  
 166.250.....GOVT, RTV, FIRE  
 166.275-169.400.....GOVT, BIFC  
 169.445.....Wireless Mikes  
 169.500.....GOVT  
 169.505.....Wireless Mikes  
 169.55-169.9875.....GOVT, MIL, USXX  
 170.000.....BIFC  
 170.025-170.150.....GOVT, RTV, FIRE  
 170.175-170.225.....GOVT  
 170.245-170.305.....Wireless Mikes  
 170.350-170.400.....GOVT, MIL  
 170.425-170.450.....BIFC  
 170.475.....PUB  
 170.4875-173.175.....GOVT, PUB, Wireless Mikes  
 173.225-173.375.....MOV, NEWS, UTIL  
 173.3875-173.5375.....MIL  
 173.5625-173.5875.....MIL Medical/Crash Crews  
 173.60-173.9875.....GOVT

FM-TV Audio Broadcast, VHF Wide Band (174-216 MHz)  
 179.750.....TV7  
 185.750.....TV8  
 191.750.....TV9  
 197.750.....TV10  
 203.750.....TV11  
 209.750.....TV12  
 215.750.....TV13

New Mobile Narrow Band (220-222 MHz)

220.000-222.000.....NEW

1 1/4-Meter Amateur Band (222-225 MHz)

222.000-225.000.....HAM

Military Aircraft Band (237.9-287.8 MHz)

237.900.....Coast Guard Search & Rescue  
 239.800.....FAA Weather  
 241.000.....Army  
 243.000.....Emergency  
 255.400.....FAA Flight Service  
 257.800.....Civilian Towers  
 287.800.....Coast Guard Air/Sea Rescue

Ultra High Frequency (UHF)-(300 MHz-3 GHz)

Military Aircraft Band (319.1-383.9 MHz)

319.100.....FAA Air Traffic Control  
 321.000-336.600.....Air Force  
 342.500-344.600.....FAA Weather  
 346.400-364.200.....Air Force Air Traffic Control  
 381.800-383.900.....Coast Guard

U. S. Government Band (406-450 MHz)

406.125-419.975.....GOVT, USXX

70-Centimeter Amateur Band (420-450 MHz)

420.000-450.000.....HAM

Low Band (450-470 MHz)

450.050-450.925.....RTV  
 451.025-452.025.....IND, OIL, TELM, UTIL  
 452.0375-453.00.....IND, TAXI, TRAN TOW, NEWS  
 453.0125-453.9875.....PUB  
 454.000.....OIL  
 454.025-454.975.....TELB  
 455.050-455.925.....RTV  
 457.525-457.600.....BUS  
 458.025-458.175.....MED  
 460.0125-460.6375.....FIRE, POL, PUB  
 460.650-462.175.....BUS  
 462.1875-462.450.....BUS, IND  
 462.4625-462.525.....IND, OIL, TELM, UTIL  
 462.550-462.725.....GMR  
 462.750-462.925.....BUS  
 462.9375-463.1875.....MED  
 463.200-467.925.....BUS



FM-TV Audio Broadcast, UHF Wide Band (470-512 MHz)

(Channels 14 through 69 in 6 MHz steps)

475.750.....	Channel 14
481.750.....	Channel 15
487.750.....	Channel 16
.....	.....
.....	.....
805.750.....	Channel 69

**Note:** Some cities use the 470-512 MHz band for land/mobile service.

Conventional Systems Band — Locally Assigned  
851.0125-855.9875..... CSB

Conventional/Trunked Systems Band — Locally Assigned  
856.0125-860.9875..... CTSB

Trunked Systems Band — Locally Assigned  
861.0125-865.9875..... TSB

Public Safety Band — Locally Assigned  
866.0125-868.9875..... PSB

33-Centimeter Amateur Band (902-928 MHz)  
902.0000-928.0000..... HAM

Private Trunked  
935.0125-939.9875..... PTR

General Trunked  
940.0125-940.9875..... GTR

Fixed Services  
941.0000-944.0000..... GOVT

Studio-to-Transmitter Broadcast Links  
944.0000-952.0000..... TVn

Private Fixed Services, Paging  
952.0000-960.0000..... PFSP

Aeronautical Navigation  
960.0000-1240.0000..... AIR

23-Centimeter Amateur Band (1240-1300 MHz)  
1240.0000-1300.0000..... HAM

## FREQUENCY CONVERSION

The tuning location of a station can be expressed in frequency (kHz or MHz) or in wavelength (meters). The following information can help you make the necessary conversions.

1 MHz (million)=1,000 kHz (thousand)

To convert MHz to kHz, multiply by 1,000

$$9.62 \text{ MHz} \times 1000 = 9620 \text{ kHz}$$

To convert from kHz to MHz, divide by 1,000.

$$\frac{2780 \text{ kHz}}{1000} = 2.780 \text{ MHz}$$

To convert MHz to meters, divide 300 by the number of megahertz.

$$\frac{300}{7.1 \text{ MHz}} = 42.25 \text{ meters}$$

# TROUBLESHOOTING

If your scanner is not working as it should, these suggestions might help you eliminate the problem. If the scanner still does not operate normally, take it to your local Radio Shack store for assistance.

Symptom	Suggestion
Scanner is on, but will not scan.	Be sure <b>SQUELCH</b> is adjusted properly.
Scanner receives stations poorly or not at all.	<ul style="list-style-type: none"><li>• Check the antenna (indoor or outdoor).</li><li>• Signals may be blocked from being received by the scanner due to metal frames or material in building. Change the scanner's location and try again.</li><li>• Be sure frequencies are programmed properly and set with the correct mode (AM, NFM, or WFM).</li></ul>
Scanner's keys or display work poorly or not at all.	The scanner's processor may be locked. Restart the scanner. See "Restarting/Resetting the Scanner."
Scanner does not work at all.	<ul style="list-style-type: none"><li>• Check the AC power cord and outlet.</li><li>• The scanner may require a reset. See "Restarting/Resetting the Scanner."</li></ul>
Scanner locks on frequencies that have an unclear transmission.	Be sure birdie frequencies are not programmed, or listen to birdie frequencies manually. See "Birdie Frequencies" in "Guide to Frequencies."

## CARE AND MAINTENANCE

---

Your Radio Shack PRO-2035 1000-Channel Programmable Home Scanner is an example of superior design and craftsmanship. The following suggestions will help you care for your scanner so you can enjoy it for years.



Keep the scanner dry. If it gets wet, wipe it dry immediately. Liquids can contain minerals that can corrode the electronic circuits.



Use and store the scanner only in normal temperature environments. Temperature extremes can shorten the life of electronic devices and distort or melt plastic parts.



Handle the scanner gently and carefully. Dropping it can damage circuit boards and cases, and can cause the scanner to work improperly.



Keep the scanner away from dust and dirt, which can cause premature wear of parts.



Wipe the scanner with a damp cloth occasionally to keep it looking new. Do not use harsh chemicals, cleaning solvents, or strong detergents to clean it.

Modifying or tampering with the scanner's internal components can cause a malfunction and might invalidate its warranty and void your FCC authorization to operate it. If your scanner is not operating as it should, take it to your local Radio Shack store for assistance.

# SPECIFICATIONS

## Frequency Coverage

HF Hi.....	25 – 28 MHz (in 5 kHz steps)
VHF Lo.....	29.7 – 50 MHz (in 5 kHz steps)
Amateur Radio .....	28 – 29.7 MHz (in 5 kHz steps)
	50 – 54 MHz (in 5 kHz steps)
	144 – 148 MHz (in 5 kHz steps)
	222 – 225 MHz (in 5 kHz steps)
	420 – 450 MHz (in 12.5 kHz steps)
	1240 – 1300.000 MHz (in 12.5 kHz steps)
FM-TV Audio .....	54 – 72 MHz (in 5 kHz steps)
	76 – 87.5 MHz (in 5 kHz steps)
	87.5 – 107.95 MHz (in 50 kHz steps)
	174 – 216 MHz (in 5 kHz steps)
Amateur Radio/Government .....	406 – 450 MHz (in 12.5 kHz steps)
Aircraft.....	108 – 136.995 MHz (in 12.5 kHz steps)
	225 – 406 MHz (in 12.5 kHz steps)
Government .....	137 – 144 MHz (in 5 kHz steps)
	406 – 450 MHz (in 12.5 kHz steps)
VHF Hi .....	148 – 174 MHz (in 5 kHz steps)
	216 – 224.9950 MHz (in 5 kHz steps)
UHF Standard.....	450 – 470 MHz (in 12.5 kHz steps)
UHF "T" .....	470 – 520.000 MHz (in 12.5 kHz steps)
	760.000 – 805.995 MHz (in 12.5 kHz steps)
UHF Public Service.....	806 – 823.995 MHz (in 12.5 kHz steps)
UHF Hi.....	849.005 – 868.995 MHz (in 12.5 kHz steps)
	894.005 – 956 MHz (in 12.5 kHz steps)
Land Mobile Service .....	72 – 76 MHz (in 5 kHz steps)
Private Fixed Services/Paging/ Aircraft Navigation/Experimental.....	956 – 1240 MHz (in 12.5 kHz steps)

## General

Channels of Operation .....	1100 Channels in Any Band Combinations (100 channels per bank x 10 banks and 100 Monitor Channels)
-----------------------------	--

**Sensitivity**

**AM (20 dB S/N with 60% modulation)**

25-520 MHz.....	2 $\mu$ V
760-1000 MHz.....	2 $\mu$ V
1000.005-1300 MHz.....	5 $\mu$ V

**NFM (20 dB S/N at 3 kHz deviation)**

25-520 MHz.....	0.5 $\mu$ V
760-1000 MHz.....	0.5 $\mu$ V
1000.005-1300 MHz.....	3 $\mu$ V

**WFM (30 dB S/N at 22.5 kHz deviation)**

25-520 MHz.....	3 $\mu$ V
760-1000 MHz.....	3 $\mu$ V
1000.005-1300 MHz.....	10 $\mu$ V

**Selectivity**

**AM**

$\pm$ 6 kHz.....	-6 dB
$\pm$ 12 kHz.....	-50 dB

**NFM**

$\pm$ 10 kHz.....	-6 dB
$\pm$ 20 kHz.....	-50 dB

**WFM**

$\pm$ 150 kHz.....	-6 dB
$\pm$ 300 kHz.....	-50 dB

Scanning Rate ..... Up to 50 channels/second

Search Rate ..... Up to 50 steps/second

Delay Time ..... 2 seconds

Priority Sampling..... 2 seconds

**Intermediate Frequencies (IF)**

1st.....	609.005-613.5 MHz
2nd.....	48.5 MHz

**IF Rejection**

612 MHz at 70 MHz (NFM).....	60 dB
612 MHz at 1000 MHz (NFM).....	60 dB

<b>Squelch Sensitivity</b>	
<b>AM/NFM Threshold</b>	
25–520 MHz.....	0.5 $\mu$ V
760–1000 MHz.....	0.5 $\mu$ V
1000.005–1300 MHz.....	3 $\mu$ V
<b>AM/NFM Tight</b>	
25–520 MHz.....	25 dB
760–1000 MHz.....	25 dB
1000.005–1300 MHz.....	20 dB
<b>WFM Threshold</b>	
25–520 MHz.....	3 $\mu$ V
760–1000 MHz.....	3 $\mu$ V
1000.005–1300 MHz.....	15 $\mu$ V
<b>WFM Tight (S/N)</b>	
25–520 MHz.....	40 dB
760–1000 MHz.....	40 dB
1000.005–1300 MHz.....	40 dB

Antenna Impedance..... 50 Ohms

**Audio Output Power**

 Jack.....	16 mW
EXT SPKR Jack.....	1.8 Watts
TAPE OUT Jack (Z=10 K Ohm).....	600 mV Nominal

Built-In Speaker ..... 3 Inches (77 mm), 8 Ohms, dynamic  
 Audio Output Power..... 1.3 Watts Nominal

**Power Requirements**

AC.....	120 Volts, 60 Hz, 18 Watts
DC.....	13.8 Volts, 10 Watts

Dimensions..... 3<sup>1</sup>/<sub>2</sub> x 9<sup>1</sup>/<sub>8</sub> x 8<sup>1</sup>/<sub>16</sub> Inches HWD  
 (90 mm x 232 mm x 210 mm)

Weight..... 70.5 Ounces  
 (2 kg)

Specifications are typical; individual units might vary. Specifications are subject to change and improvement without notice.

# NOTES

---

---

## U.S. PATENT NOS.

3,794,925  
3,801,914  
3,961,261  
3,962,644  
4,027,251  
4,092,594  
4,123,715  
4,245,348