

ServiceManual

20-309/9309

**PRO-60
PROGRAMMABLE SCANNER**

Catalog Number: 20-309/9309

CONTENTS

	Page
Specifications	2
Block Diagram	4
Theory of Operation	5
General Operation Outline	6
Reception Check	8
Alignment and Adjustment	9
Troubleshooting	15
Printed Circuit Boards	18
Wiring Diagram	21
Exploded View	22
Mechanical Parts List	23
Electrical Parts List	24
Semiconductor Lead Identification	47
Microprocessor (IC1) Port Format	52
Schematic Diagram	53

SPECIFICATIONS

Frequency coverage	30 MHz–87.495 MHz	5 kHz steps
	87.5 MHz–107.950 MHz	50 kHz steps
	108 MHz–136.975 MHz	25 kHz steps
	137 MHz–224.995 MHz	5 kHz steps
	225 MHz–399.9875 MHz	12.5 kHz steps
	400 MHz–512 MHz	12.5 kHz steps
	*1 760 MHz–824 MHz	12.5 kHz steps
	*1 849 MHz–869 MHz	12.5 kHz steps
	*1 894 MHz–999.9875 MHz	12.5 kHz steps

*1 760 MHz –999.9875 MHz for 20-9309

		Unit	Nominal	Limit	
Sensitivity					
NFM: (S+N)/N=20 dB	30–512 MHz	μV	1	2	
Dev.: 3 kHz at 1 kHz	760–999.9875 MHz	μV	1	3	
AM: (S+N)/N=20 dB	30–512 MHz	μV	2	5	
Mod. 60% at 1 kHz	760–999.9875 MHz	μV	2	5	
WFM: (S+N)/N=30 dB	30–512 MHz	μV	3	10	
Dev. 45 kHz at 1 kHz	760–999.9875 MHz	μV	3	10	
Squelch sensitivity					
NFM and AM					
Threshold		μV	0.5	2	
Tight		dB	25	15	
WFM					
Threshold		μV	3	10	
Tight		dB	40	30	
Spurious rejection	at 328 MHz (NFM)	dB	40	30	
(except primary image)					
Modulation acceptance (EIA RS-204-A)					
NFM		kHz	±8	±5	
WFM		kHz	±150	±75	
Signal to noise ratio					
NFM	Dev.: 3 kHz at 1 kHz	30–512 MHz	dB	40	30
	Input 100 μV	760–999.9875 MHz	dB	35	25
AM	Mod.: 60% at 1 kHz	30–512 MHz	dB	40	30
	Input 100 μV	760–999.9875 MHz	dB	40	30
WFM	Dev.: 45 kHz at 1 kHz	30–512 MHz	dB	50	35
	Input 100 μV	760–999.9875 MHz	dB	50	35

		Unit	Nominal	Limit
Residual noise	Volume control, set to its minimum, squelched	mV	3	5
Scanning rate		channels/sec.	25	22-28
Search rate		steps/sec.	50	47-53
Priority sampling		sec.	2	1-3
Scan delay time		sec.	2	1-3
Audio output power	10% THD	mW	180	150
Current drain	Squelched	mA	100	115
Channels of operation	Any 200 channels in any band combination			
Channels, frequency, and mode display	Liquid crystal display			
Receiving system	Direct key entry digital-control synthesizer, 1st IF: 608.005–611.2 MHz 2nd IF: 45 MHz 3rd IF: 10.7 MHz (WFM), 455 kHz (NFM/AM)			
Power source	9 V DC negative ground only 6 AA batteries or a suitable adapter			
Jacks	Antenna, earphone, external power, and charge			
Dimensions (HWD)	5 7/8 x 2 1/4 x 1 3/4 inches (150 x 62 x 44 mm)			
Weight	8.8 oz. (250 g) without antenna and batteries			

Note: Nominal specs represent the design specs. All units should be able to approximate these—some will exceed and some may drop slightly below these specs. Limit specs represent the absolute worst condition that still might be considered acceptable; in no case should a unit fail to meet limit specs.

BLOCK DIAGRAM

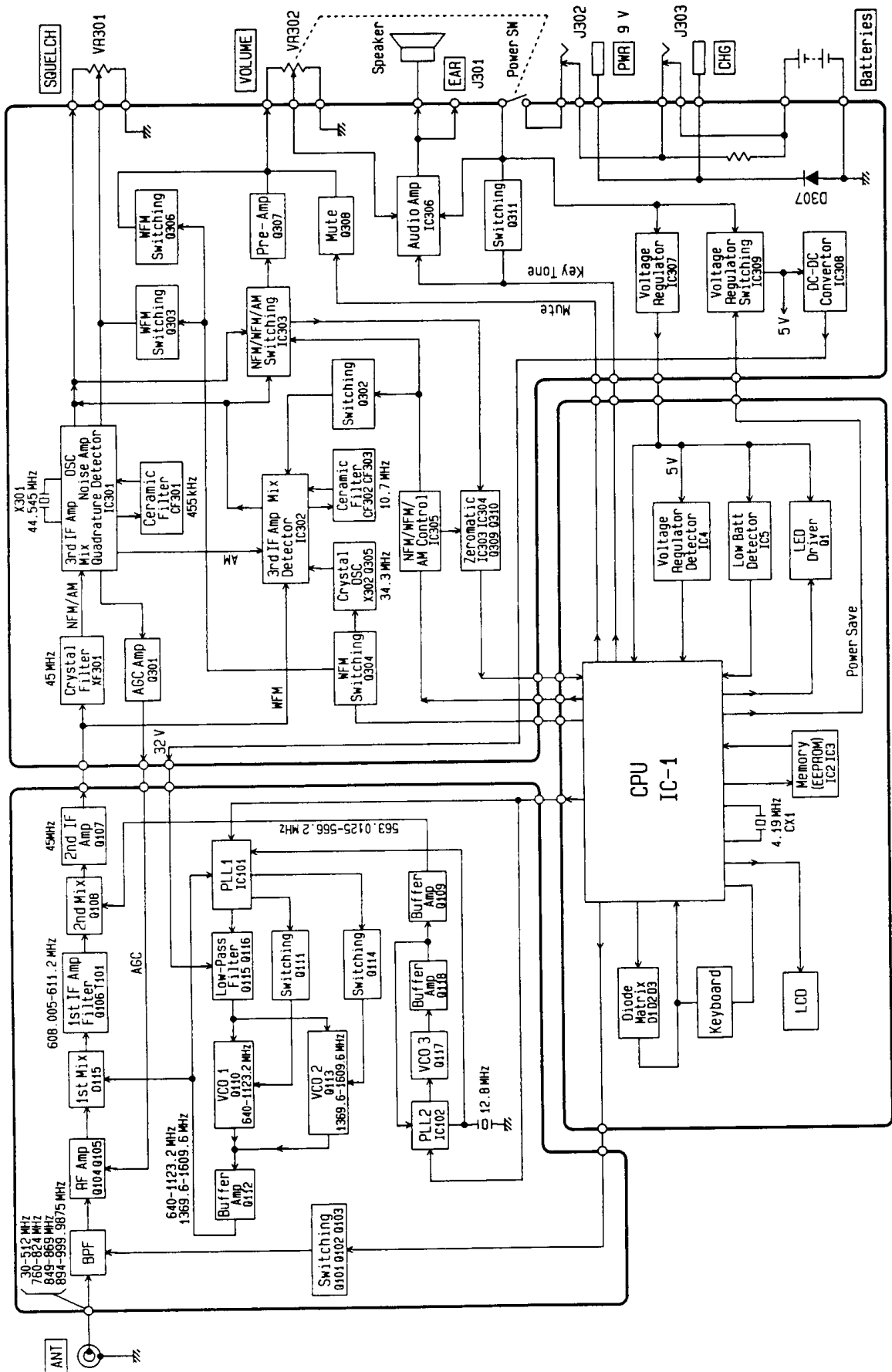

THEORY OF OPERATION

The PRO-60 is a PLL (Phase-Locked Loop) synthesized VHF/UHF, AM/FM receiver, controlled by a CPU (Central Processing Unit) via a keyboard.

Receiving mode and search step are initially set to correspond with the frequencies entered. When a frequency within the FM broadcast band is keyed in, the receiving mode is set to wideband FM (WFM). When a frequency in the active radio band, such as police, fire, and ham radio, is keyed in, the mode is set to narrowband FM (NFM), and when a frequency in the aircraft band is keyed in, it sets to AM mode. The mode can also be changed by the AM/FM/WFM key.

All functions, such as the receiving frequency range, frequency determination, scanning and delay time, etc. are controlled by the CPU (IC1). The CPU is able to do only the assigned functions and no modification of the CPU is feasible.

The following paragraphs explain the operation of the circuit in terms of the functional blocks:

Varactor (variable capacitance diode) tuning (automatic tuning system) is employed on all bands.

The RF input circuit consists of the bandpass filters (BPF). A signal generated by VCO1 or VCO2 is applied to the 1st mixer and mixed with the RF signal. The 1st mixer is employed to facilitate 30 MHz to 999.9875 MHz mixing.

The 1st IF (Q106) is 608.005 - 611.2 MHz, and the signal is mixed with VCO3 frequency at the 2nd mixer (Q107) to produce a 45 MHz signal. Corresponding with the input from the keyboard, the CPU selects VCO1 or VCO2 and determines the AM/NFM/WFM data of the PLL circuit that will function; then it outputs the necessary data.

A signal entered to NFM/AM IF is mixed with crystal oscillation frequency 44.545 MHz at the 3rd mixer (IC301) and converted to a 455 kHz signal. A signal entered to WFM IF is mixed with crystal oscillation frequency 34.3 MHz at the 3rd mixer (IC302) and converted to a 10.7 MHz signal. The signal is further amplified to be detected as an AF signal.

The AF signal of AM, NFM, and WFM is CPU-controlled and applied to the AF power amplifier (IC306) via a switching circuit. Squelch signals are comprised of noise products from detector output, and amplified by IC301 through a switching signal, which controls the AF mute and CPU.

CX1 (4.19 MHz) is a clock which controls the CPU. Figure A shows the clock waveform at IC1 pin 58.

The unit has a battery-saving control in manual mode. When the unit is in operation, IC1 pin 61 is "H" and IC309 is on. If there has been no signal input or no key input for more than 5 seconds in manual mode with squelch on, pin 61 goes "L" (Figure B), turning off IC309 to shut off the power supply for most of the circuits (except the CPU and audio circuit). In this battery-saving mode, the unit uses only 40% of the power required for normal operation.

Any unstable supply voltage to the CPU can produce a CPU malfunction, such as wrong data processing, wrong data transfer, etc. To overcome this, the CPU can be initialized when necessary. To initialize the CPU, press and hold CLEAR and 0, and then turn on the power.

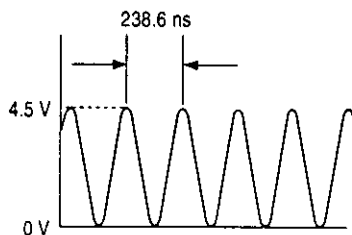

Figure A

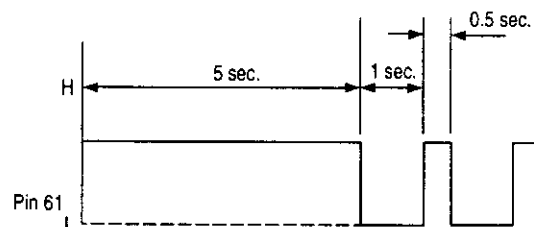
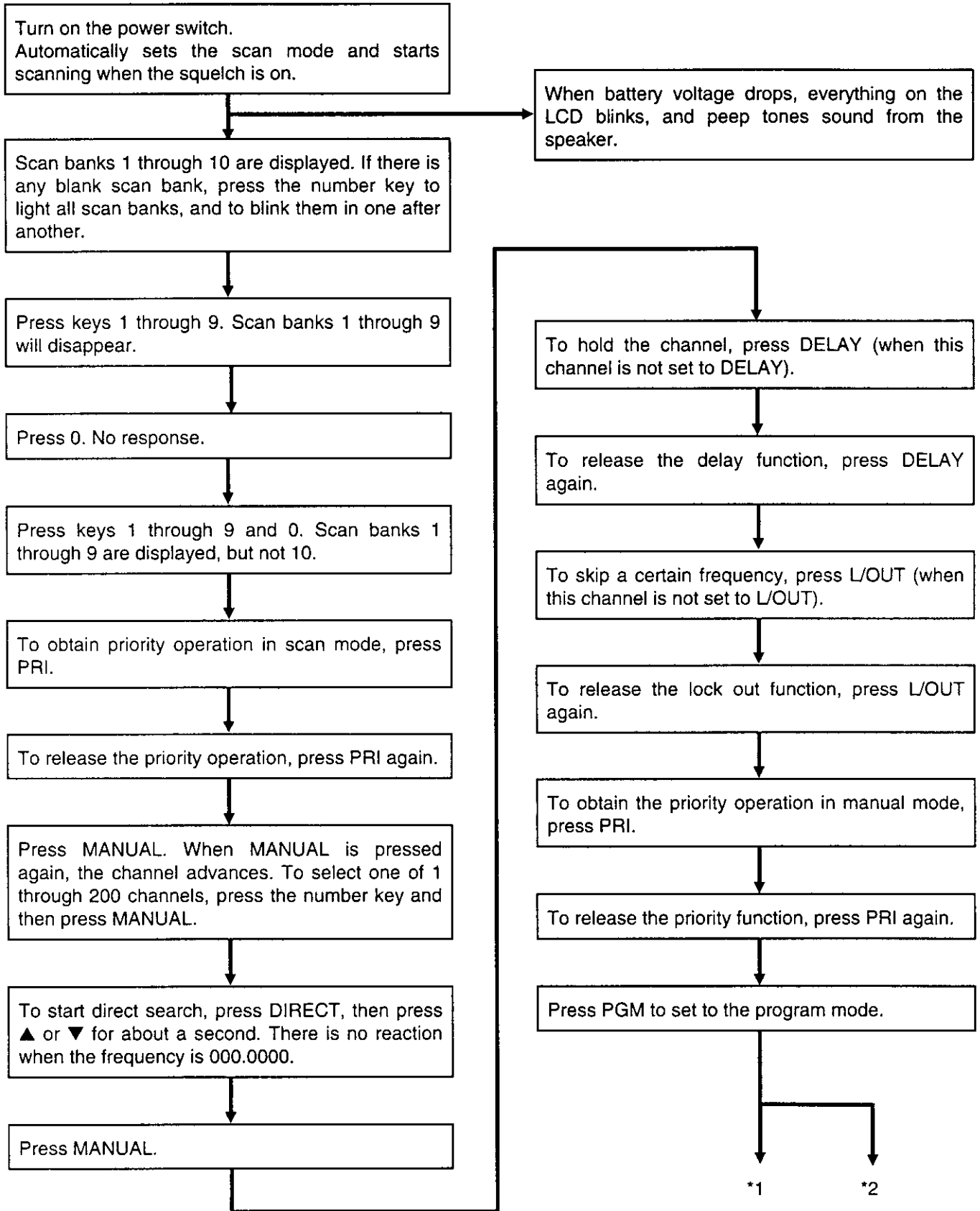

Figure B

GENERAL OPERATION OUTLINE



*1

Enter the desired frequency in each channel as follows.

Enter the desired frequency with the numeral keys.

Press ENTER to memorize the frequency. If a wrong frequency (out of band) is entered, "Error" will be displayed. Press CLEAR, then enter the correct frequency.

Press PGM to advance to the next channel. Enter the frequency and press ENTER. Repeat it to memorize the frequencies one by one.

Press PRI so the priority channel appears.

To revert to the previous channel, press PRI again.

Press numeral keys 1 through 200 and then press PRI. The priority channel is set to the newly entered channel.

To call the monitor channel, press MON.

Press MON so that the next monitor channel appears.

To call the monitor channel directly, press the numeral keys.

*2

Enter the limit search frequency as follows.

Press LIMIT and enter the lower frequency of the range to search.

Press ENTER.

Press LIMIT and enter the upper frequency of the range to search.

Press ENTER.

Press and hold ▲ or ▼ for about a second to start frequency search (squelch must be on).

To change the receiving mode, press AM/FM/WFM.

To return to the default mode, press AM/FM/WFM while pressing and holding CLEAR.

Press MON to store the desired frequency (10 monitor channels) in the search mode.

To continue search, press and hold ▲ or ▼ for about a second.

To revert to the previous channel, press PGM.

Turn on the KEY LOCK switch so the keys will not function except SCAN, MAN, and LIGHT.

RECEPTION CHECK

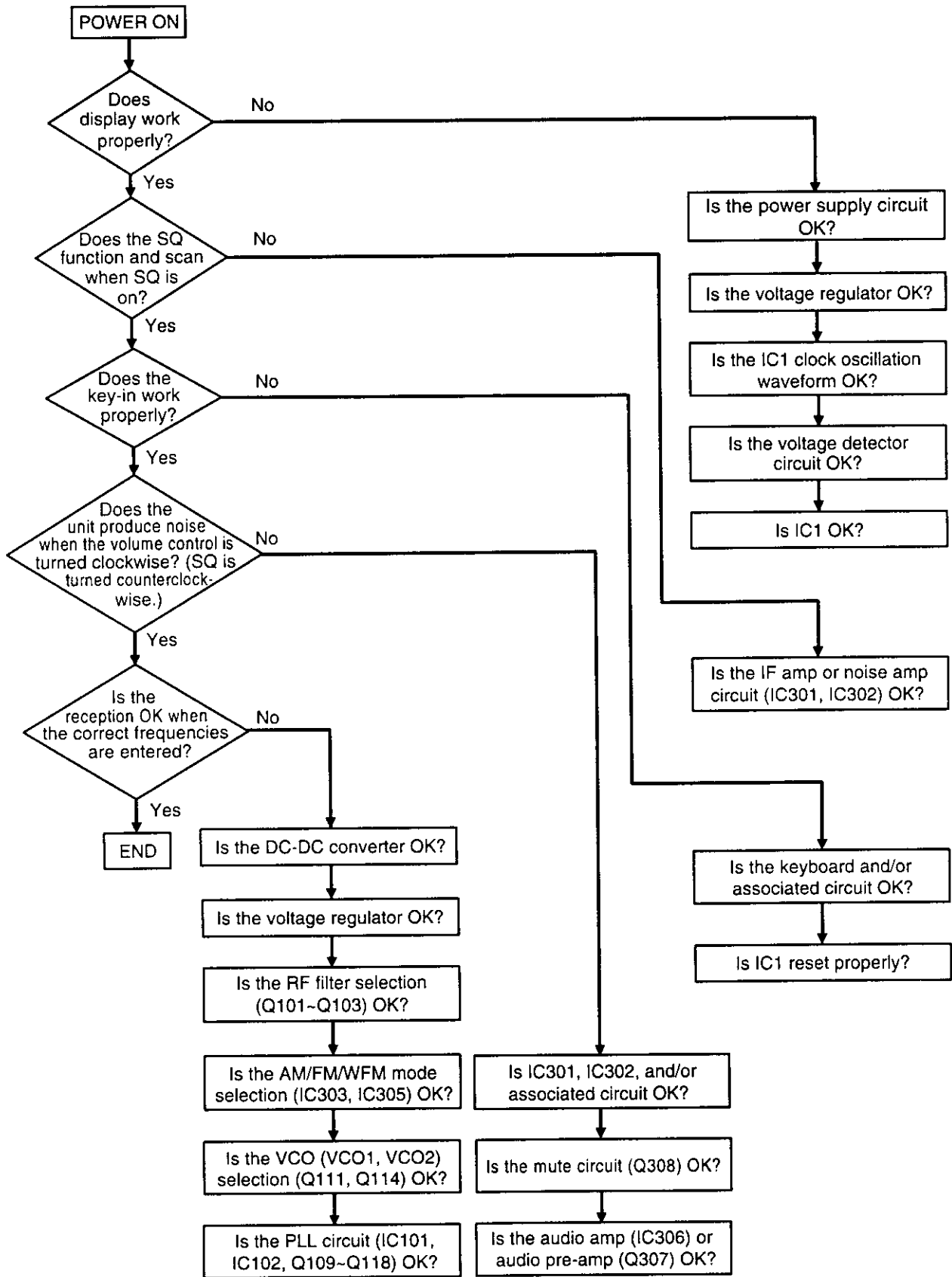

ALIGNMENT AND ADJUSTMENT

ALIGNMENT AND TEST POINTS

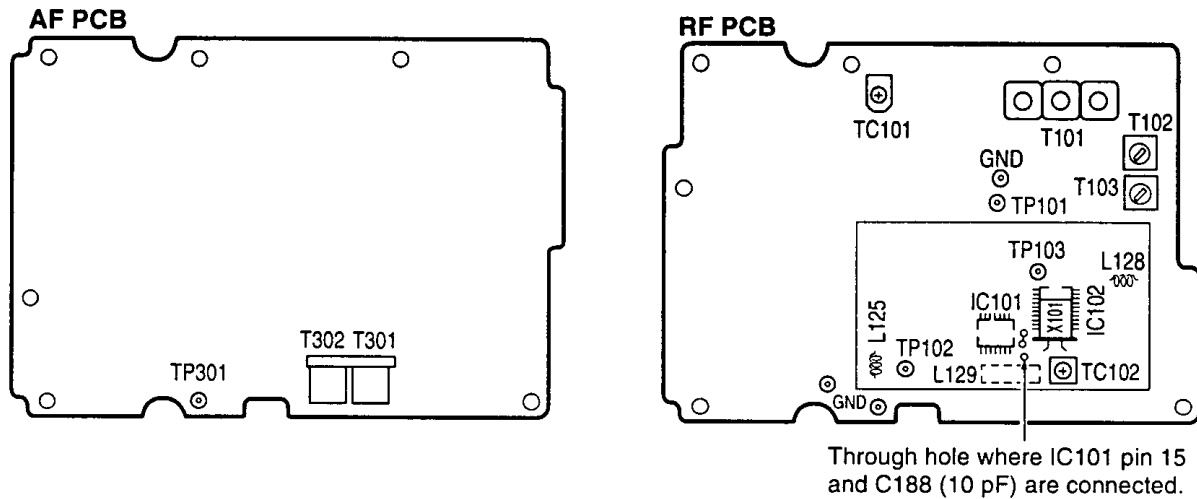

ALIGNMENT PREPARATION

Test Equipment Required

- Oscilloscope
- AC SSVM
- DC SSVM
- 8-ohm dummy load
- AM/FM signal generator
- Distortion meter
- Frequency counter

Notes:

- Use non-metallic tuning tools.
- The test equipment and receiver should be warmed up for at least 10 minutes before proceeding with alignment.
- The signal level from the generator should be kept as low as possible to obtain a usable output.

Program channels 1 through 10 are as follows:

Table 1

Channel	Frequency and Band Mode	Channel	Frequency and Band Mode
1	512 MHz (NFM)	6	155 MHz (NFM)
2	98 MHz (WFM)	7	225 MHz (NFM)
3	30 MHz (NFM)	8	126 MHz (AM)
4	760 MHz (NFM)	9	31.995 MHz (NFM)
5	999.9875 MHz (NFM)	10	32 MHz (NFM)

ALIGNMENT PROCEDURES

PLL2 VCO Alignment

Control Setting	Test Instrument Connection	Adjust	Result
OFF/VOLUME control: ON. SQUELCH control: Fully counterclockwise (CCW). Select channel 3.	Connect DC SSVM to TP103. See Figure 1.	L128	Adjust L128 to 2.4 ± 0.1 volts on the DC SSVM. See Table 2.

PLL1 VCO Alignment

Control Setting	Test Instrument Connection	Adjust	Result
OFF/VOLUME control: ON. SQUELCH control: CCW. Select channels 3 and 4.	Connect DC SSVM to TP102. See Figure 2.	L125	<ol style="list-style-type: none"> Select channel 3 and adjust L125 for 25.5 ± 0.5 volts on the DC SSVM. Select channel 4 and be sure the DC SSVM reads 0.8-3.0 volts (no adjustments are necessary for the coil). See Table 2.

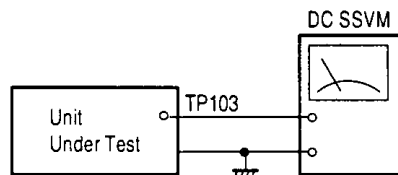

Figure 1

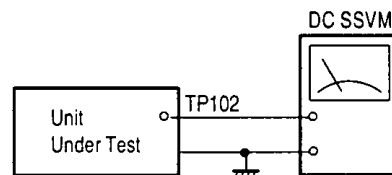

Figure 2

Adjustment of Coils L125 and L128

Each coil should be adjusted carefully by changing the pitch of the coil little by little by using a non-metallic tuning tool as shown in Figure 3.

Squeeze the coil to increase the voltage and stretch the coil to decrease the voltage.

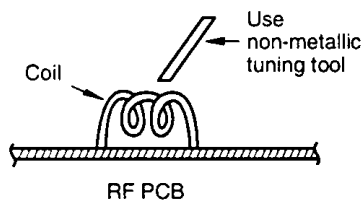

Figure 3

Notes:

- Be very careful when doing coil pitch adjustment because it greatly affects the frequency.
- Secure the coil with glue after alignment. Be sure the glue is dry and the coil is secured. Also, be sure that the environmental temperature is normal. Then, repeat VCO (PLL2 and PLL1) alignments above.

Table 2

CH	Frequency	Voltage
CH3	30 MHz	Voltage at TP103: 2.3-2.5 volts
CH3	30 MHz	Voltage at TP102: 25-26 volts
CH4	760 MHz	Voltage at TP102: 0.8-3.0 volts

Reference Frequency Osc. Alignment

Control Setting	Test Instrument Connection	Adjust	Result
OFF/VOLUME control: ON. SQUELCH control: CCW. Select channel 1.	Connect the frequency counter to TP101. See Figure 4.	TC102	Adjust TC102 so the frequency is 1123.200000 MHz \pm 200 Hz.

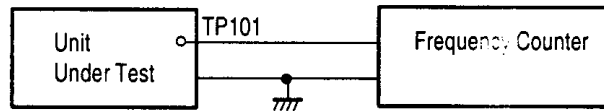

Figure 4

Note: If no frequency counters capable of measuring 1200 MHz are available, use a frequency counter capable of measuring 20 MHz. Follow the instructions below so the frequency counter can do an appropriate adjustment.

1. The frequency counter for measurement should be accurate within 1 Hz.
2. Be sure a 2 pF capacitor is connected to the end of the cable of the signal line. The unit would be destroyed if you did not use this capacitor.
If a capacitor other than the 2 pF capacitor is used, or if the capacitor is connected anywhere other than the end of the measurement cable, correct measurement will never be obtained because of the effects on the oscillator.
3. Be sure the coaxial cable for measurement is as short as possible (shorter than 1 meter) to avoid stray capacitance effects.
4. Test point locations and adjustment frequency range are as follows:

Pin 15 of IC101 and C188 (10 pF) are connected to a through hole, as shown in "Alignment and Test Points" (Page 9). Connect a 2 pF capacitor at a through hole pattern location and then adjust TC102 so that the frequency range is 12.799937 MHz \pm 2 Hz.

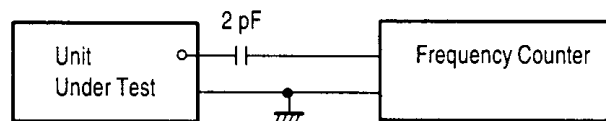

Figure 5

NFM/AM Discriminator Coil Alignment

Control Setting	Test Instrument Connection	Adjust	Result
OFF/VOLUME control: ON. SQUELCH control: CCW. Select channel 1.	Connect the signal generator to the Ant. connector and the DC SSVM to TP301. See Figure 6.	T301	Set the signal generator frequency to 512 MHz, 100 μ V output (no mod.), and adjust T301 to \pm 0.1 volt on the DC SSVM.

WFM Discriminator Coil Alignment

Control Setting	Test Instrument Connection	Adjust	Result
OFF/VOLUME control: ON. SQUELCH control: CCW. Select channel 2.	Connect the signal generator to the Ant. connector and the DC SSVM to TP301. See Figure 6.	T302	Set the signal generator frequency to 98 MHz, 100 μ V output (no mod.), and adjust T302 to 1.8 ± 0.1 volts on the DC SSVM.

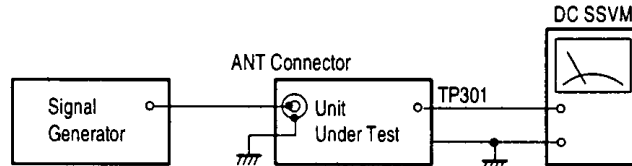

Figure 6

45 MHz 2nd IF Coil Alignment

Control Setting	Test Instrument Connection	Adjust	Result
OFF/VOLUME control: ON. SQUELCH control: CCW. Select channel 8.	Connect the signal generator to the Ant. connector, and the oscilloscope, AC SSVM, distortion meter, and 8-ohm load to EXT. speaker jack. See Figure 7.	T102 T103	<ol style="list-style-type: none"> Set the signal generator frequency to 126 MHz. AM: 60% modulation at 1 kHz and output at S/N 20 dB point. Adjust T102 and T103 for maximum sensitivity.

IF Trap Trimmer Capacitor Alignment

Control Setting	Test Instrument Connection	Adjust	Result
OFF/VOLUME control: ON. SQUELCH control: CCW. Select channel 1.	Connect the signal generator to the Ant. connector, and the oscilloscope, AC SSVM, distortion meter, and 8-ohm load to EXT. speaker jack. See Figure 7.	TC101	<ol style="list-style-type: none"> Set the signal generator frequency to 611.2 MHz. FM: 3 kHz deviation, 1 kHz modulation, and output approx. 300 μV. Adjust TC101 to minimum sensitivity.

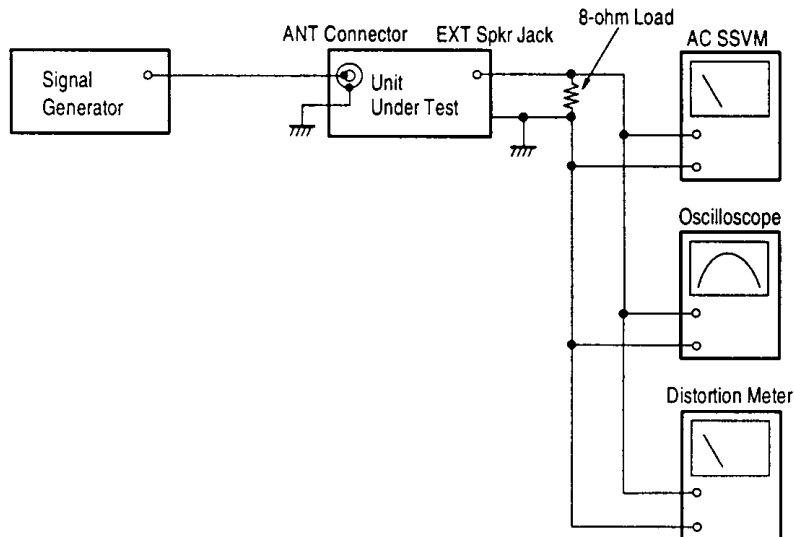

Figure 7

1st IF BPF Coil Alignment

Normally, additional adjustment is not necessary for BPF coil T101 since it has been factory aligned. Only when the shape or pitch of T101 gets changed accidentally, readjustment is required as described below, referring to Figure 7.

Control Setting	Test Instrument Connection	Adjust	Result
OFF/VOLUME control: ON. SQUELCH control: CCW. Select channels 9 and 10.	Connect the signal generator to the Ant. connector, and the oscilloscope, AC SSVM, distortion meter, and 8-ohm load to EXT. speaker jack. See Figure 7.	T101	<ol style="list-style-type: none"> Select channel 9 and set the signal generator frequency to 31.995 MHz. FM: 3 kHz deviation, 1 kHz modulation, and 0.5 mV output. Adjust T102 to maximum sensitivity. Select channel 10 and set the signal generator frequency to 32 MHz. FM: 3 kHz deviation at 1 kHz and 0.5 μV output. Readjust T102 to maximum sensitivity. <p>Note: Align the balance of channel 9 and channel 10 sensitivity to be the same. See Figure 8.</p>

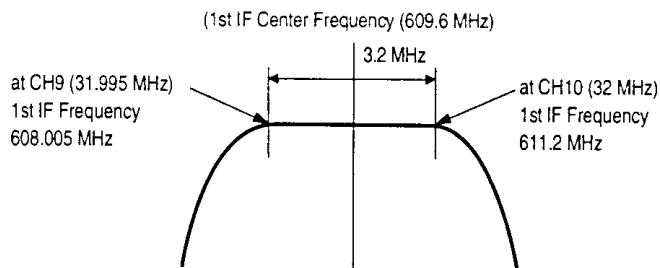
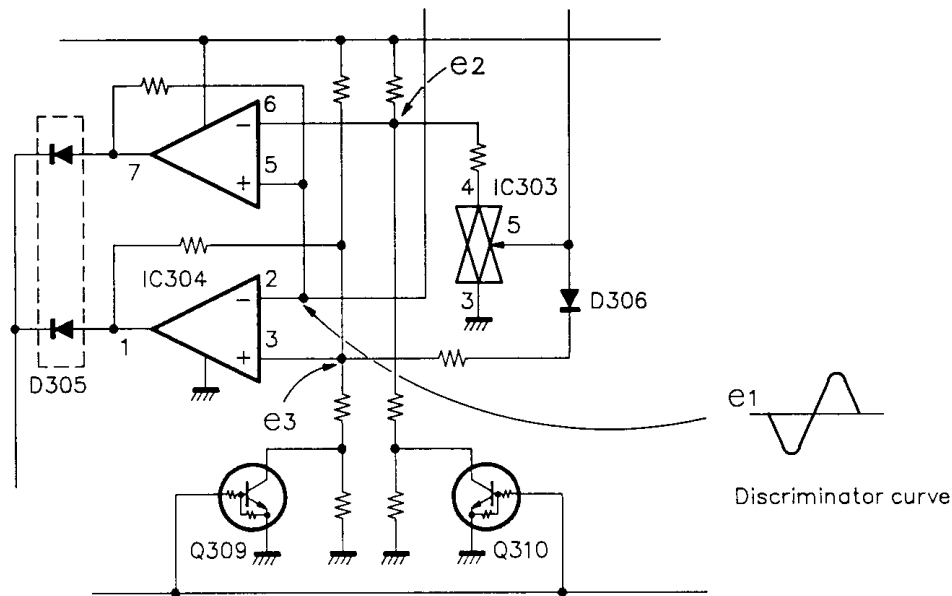

Figure 8

Zeromatic Function Test Procedure



Zeromatic function operates when output is "H."

	$0 < e1 < e3$	$e3 < e1 < e2$	$e2 < e1 < V_{cc}$
Output (D305 Cathode)	L	H	L

To adjust voltage e1, receive the signal in manual mode and:

- In AM/NFM mode, set T301 to obtain 1.0 ± 0.1 volt DC at TP301.
- In WFM mode, set T302 to obtain 1.8 ± 0.1 volt DC at TP301.

See "NFM/AM Discriminator Coil Alignment" and "WFM Discriminator Coil Alignment" on Page 11 and 12.

If the zeromatic does not function correctly, refer to "Reference Frequency Osc. Alignment" (Page 11), check that the frequency is $1123.200000 \text{ MHz} \pm 200 \text{ Hz}$, and adjust discriminator coil (T301, T302).

TROUBLESHOOTING

Symptom	Possible Cause/Remedy
Display does not light and no sound comes out when power is on Volume control: Maximum (MAX) Squelch control: Counterclockwise (CCW).	<ul style="list-style-type: none"> • Defective batteries: Replace. • Wrong polarity of batteries: Correct the polarity of batteries. • Defective power jack or charge jack: Replace. • Defective ON/OFF switch on volume control: Replace.
Display lights but there is no sound Volume control: MAX Squelch control: CCW	<ul style="list-style-type: none"> • Defective speaker or headphone jack: Replace. • Defective audio amplifier circuit (IC306) and/or associated circuit: Replace the defective components. • Defective IF amplifier (IC301) and/or associated circuit: Replace the defective components. • Defective squelch control (VR301) and/or associated circuit: Replace the defective components. • Defective AF pre-amp circuit (Q307) and/or associated circuit: Replace the defective components. • Defective audio mute switching circuit (Q308) and/or associated circuit: Replace the defective components. • Defective switching circuit (IC303) and/or associated circuit: Replace the defective components.
Sound comes out but display does not light Volume control: MAX Squelch control: CCW	<ul style="list-style-type: none"> • Defective LCD or rubber connector: Replace the defective components. • Defective CPU (IC1): Replace IC1.
Does not scan and squelch does not operate	<ul style="list-style-type: none"> • Defective IC301 or IC302 squelch control terminal: Replace IC301 or IC302.
Does not scan but squelch operates	<ul style="list-style-type: none"> • Defective CPU (IC1): Replace IC1.
Shows correct display at the time of programming, but after scanning, shows faulty display	<ul style="list-style-type: none"> • Defective CPU (IC1) and/or associated circuit: Replace the defective components.
Sound does not come out in NFM mode but AM and WFM operate	<ul style="list-style-type: none"> • Defective IC1: Replace. • Defective control circuit (IC303, IC305) and/or associated circuit: Replace the defective components.

Symptom	Possible Cause/Remedy
Sound does not come out in AM mode but NFM and WFM operate	<ul style="list-style-type: none"> • Defective IC1: Replace. • Defective switching circuit (IC303, IC305) and/or associated circuit: Replace the defective components.
Sound does not come out in AM and NFM modes but WFM operates	<ul style="list-style-type: none"> • Defective IC301 and/or associated circuit: Replace the defective components.
Sound does not come out in WFM mode but AM and NFM operates	<ul style="list-style-type: none"> • Defective IC1: Replace IC1. • Defective switching circuit (IC303, IC305, Q303, Q304, Q306) and/or associated circuit: Replace the defective components.
Sound does not come out in WFM and AM modes but NFM operates	<ul style="list-style-type: none"> • Defective IC102 and/or associate circuit: Replace the defective components. • Defective switching circuit (IC303, IC305) and/or associated circuit: Replace the defective components.
Low sensitivity between 30.000 and 87.495 MHz	<ul style="list-style-type: none"> • Defective decoder switching circuit (Q101): Replace Q101. • Defective bandpass filter (BPF): Replace the defective components.
Low sensitivity between 87.5 and 174 MHz	<ul style="list-style-type: none"> • Defective switching circuit (Q102): Replace Q102. • Defective BPF: Replace the defective components.
Low sensitivity between 174.005 and 350 MHz	<ul style="list-style-type: none"> • Defective switching circuit (Q102): Replace Q102. • Defective BPF: Replace the defective components.
Low sensitivity between 350 and 512 MHz	<ul style="list-style-type: none"> • Defective switching circuit (Q103): Replace Q103. • Defective BPF: Replace the defective components.
Low sensitivity between 760 and 999.9875 MHz	<ul style="list-style-type: none"> • Defective switching circuit (Q103): Replace Q103. • Defective BPF: Replace the defective components.
Does not operate between 30 and 512 MHz	<ul style="list-style-type: none"> • Defective Q110 and/or VCO1 circuit: Replace the defective components.
Does not operate between 760 and 999.9875 MHz	<ul style="list-style-type: none"> • Defective Q113 and/or VCO2 circuit: Replace the defective components.
All bands do not operate but display is OK.	<ul style="list-style-type: none"> • Defective PLL (IC101, IC102, IC1) and/or associated circuit: Replace the defective components.

Symptom	Possible Cause/Remedy
Searches but does not halt on the correct frequency.	<ul style="list-style-type: none"> • Defective IC303, IC304, IC305, Q309, Q310: Replace. • Discriminator coil T301, T302 are out of adjustment: Readjust T301 and/or T302. • Refer to "Reference Frequency Osc. Alignment" on Page 11.
Does not make peep tone.	<ul style="list-style-type: none"> • Defective IC1 and/or associated circuit: Replace the defective components.
Does not blink nor make peep tone when battery voltage has gone down.	<ul style="list-style-type: none"> • Defective IC5 and/or associated circuit: Replace the defective components.

PRINTED CIRCUIT BOARD

AF

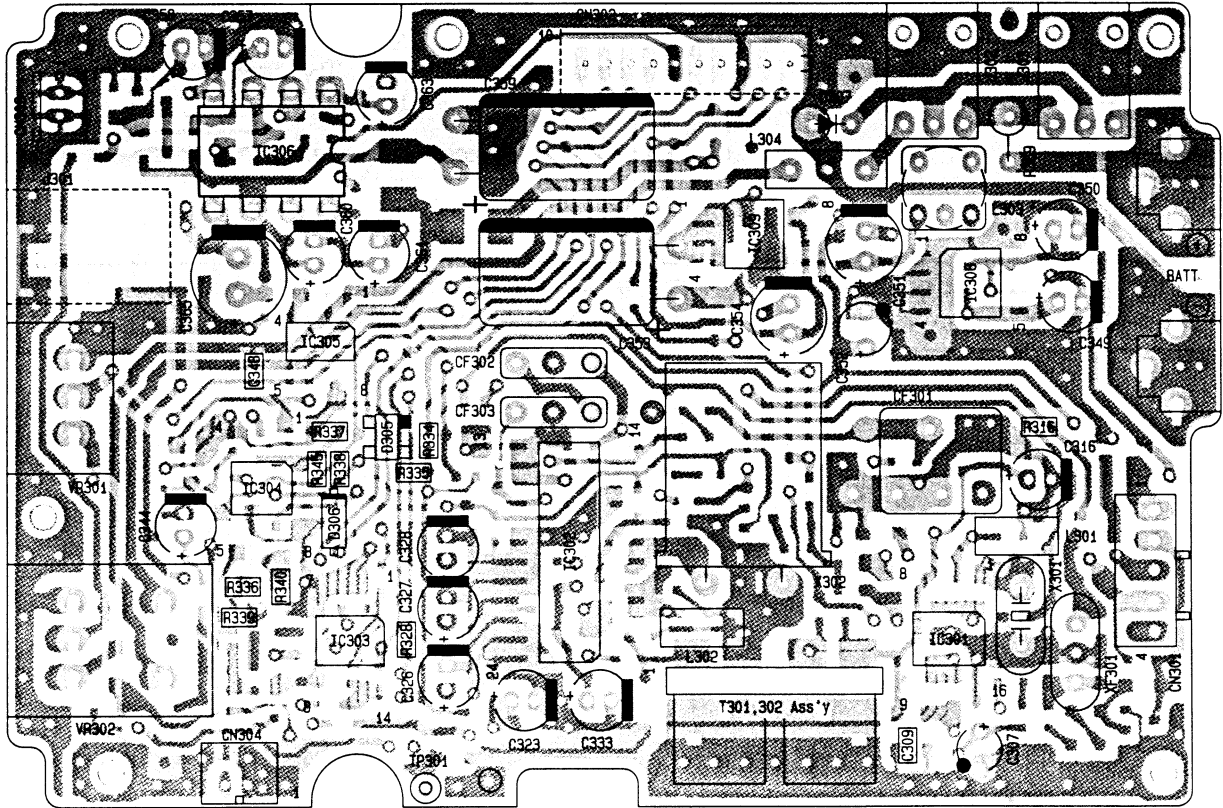

Top View

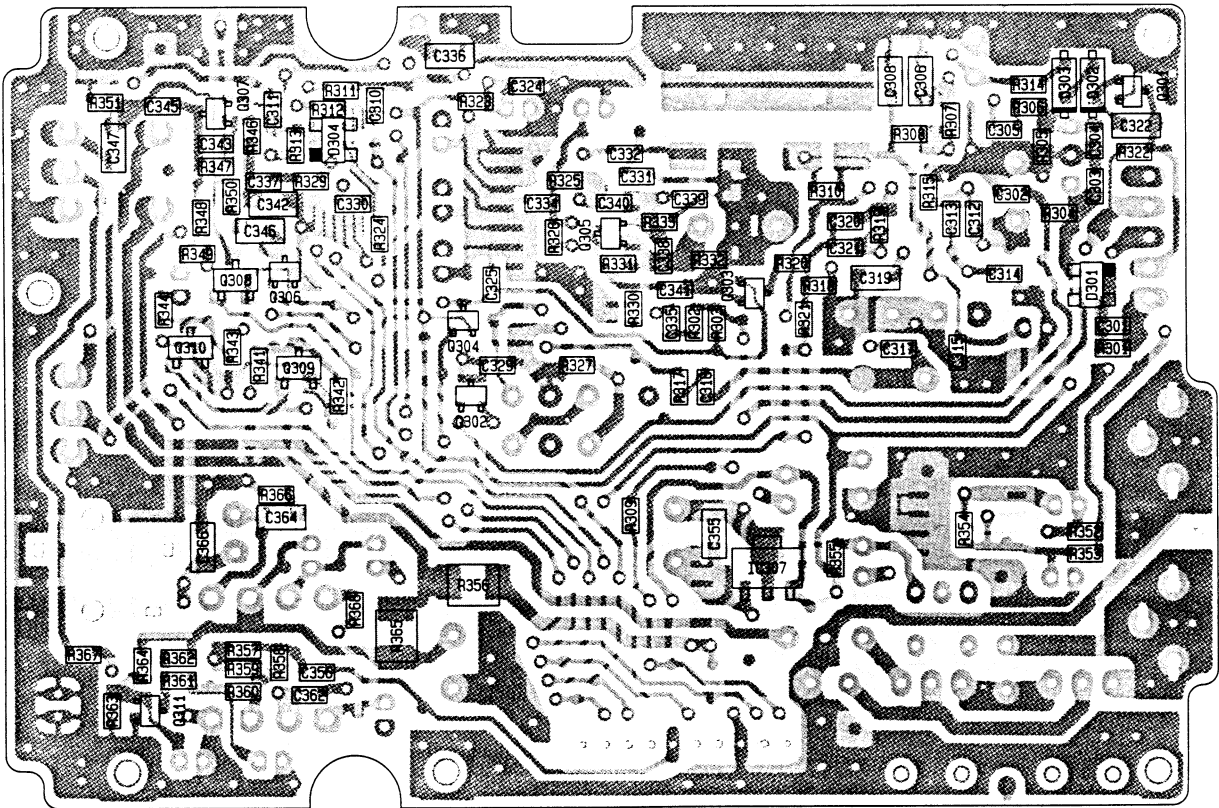

Bottom View

LOGIC

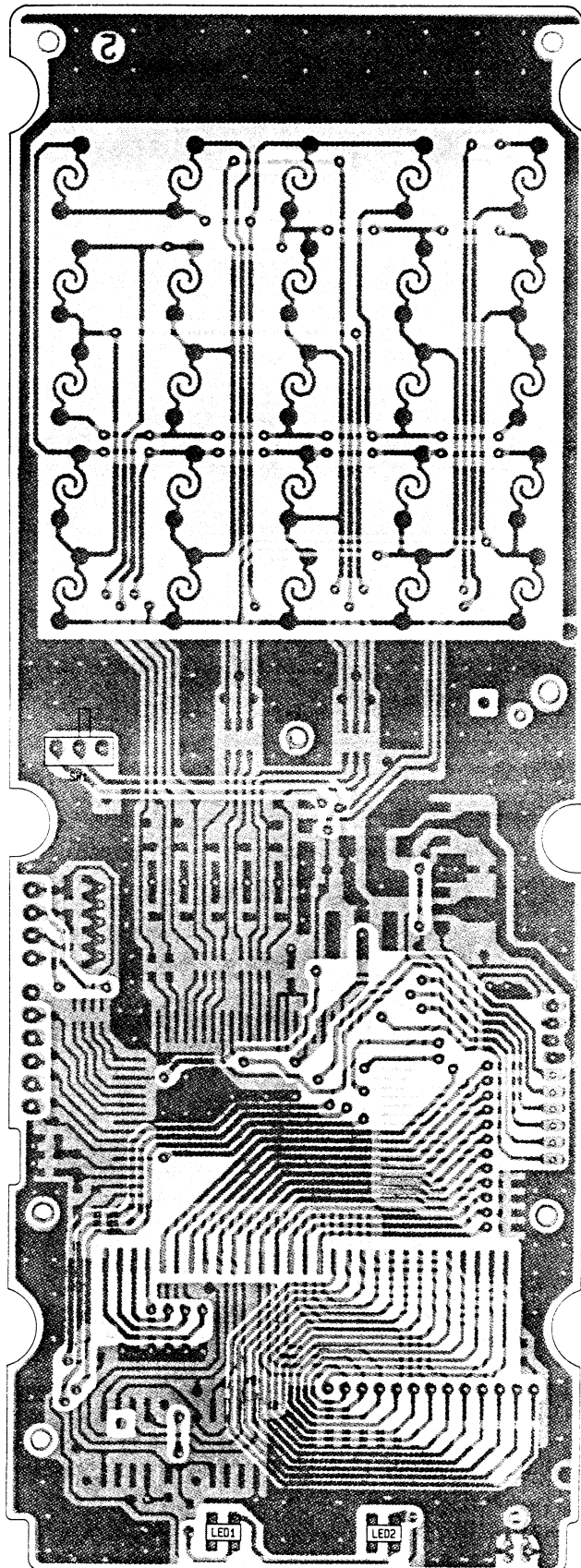
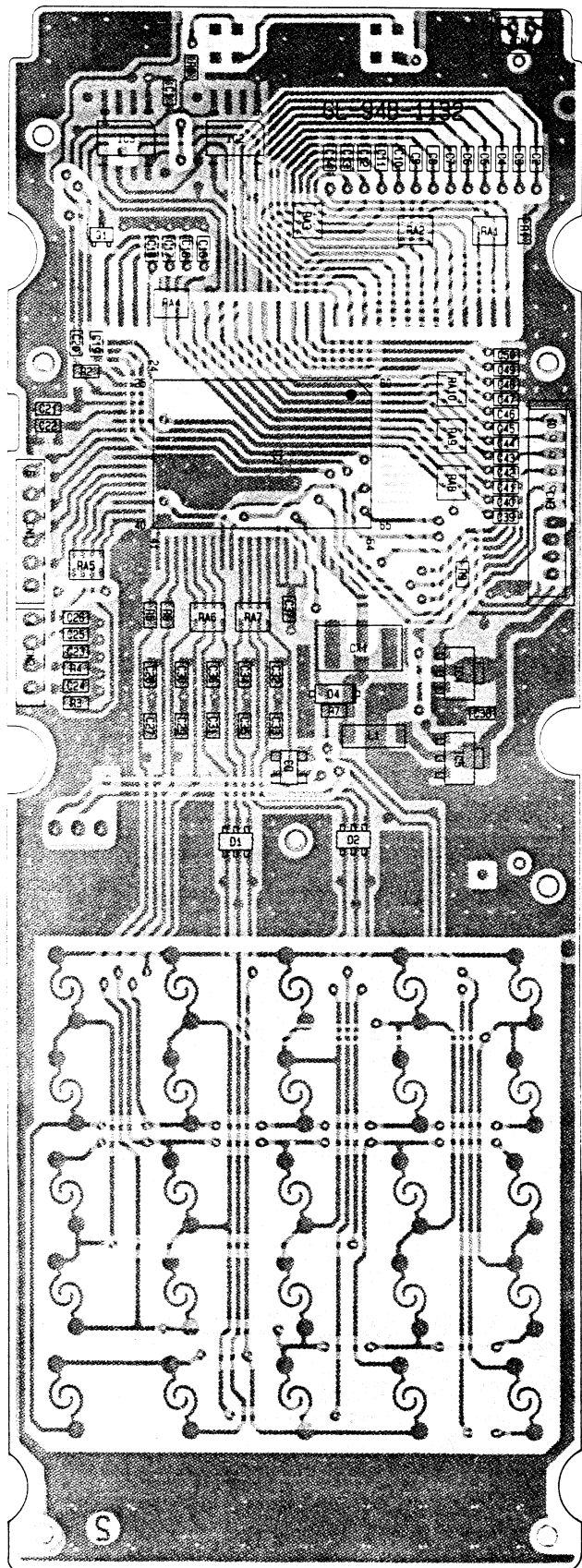

Bottom View

WIRING DIAGRAM

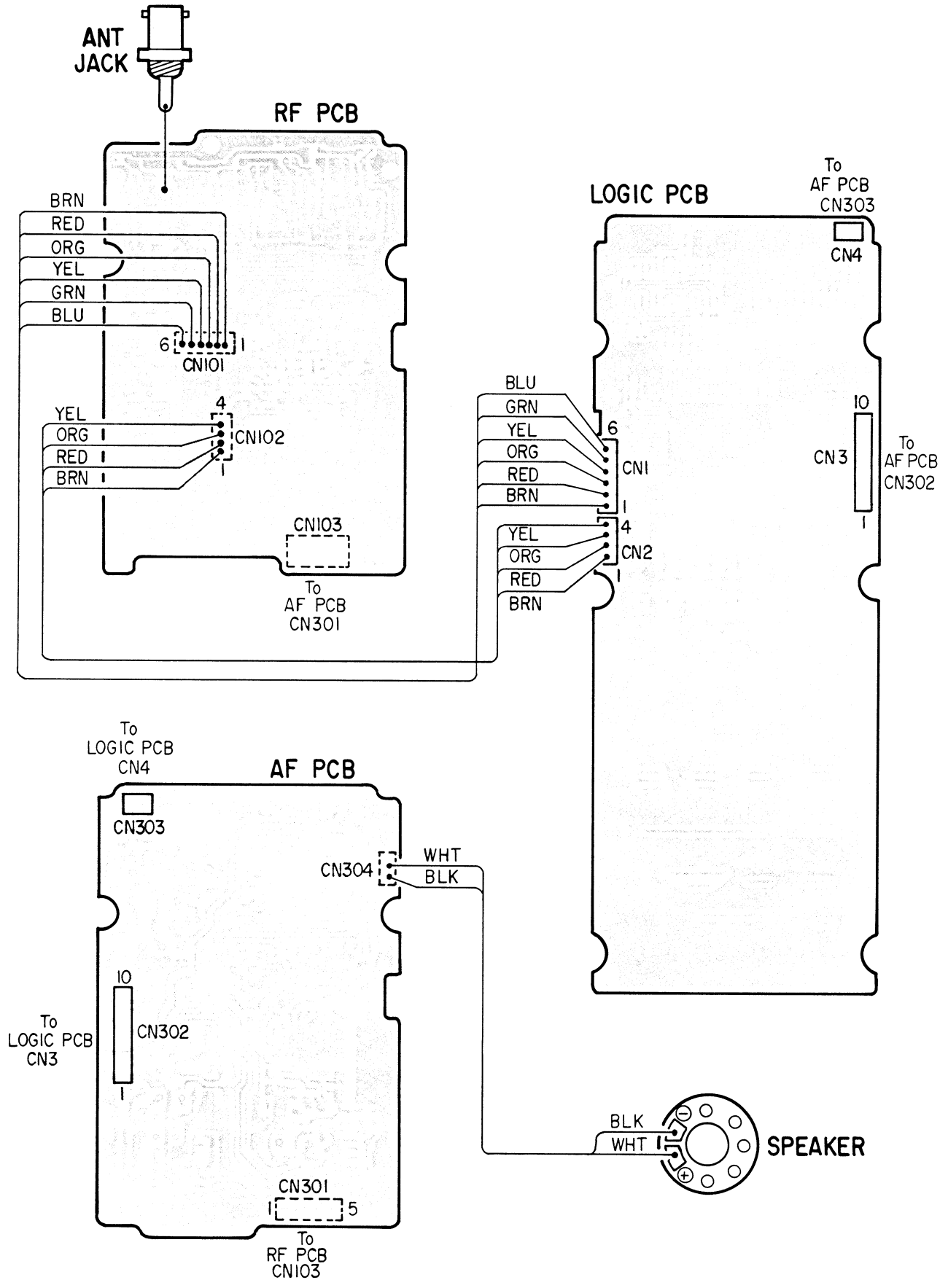

EXPLODED VIEW

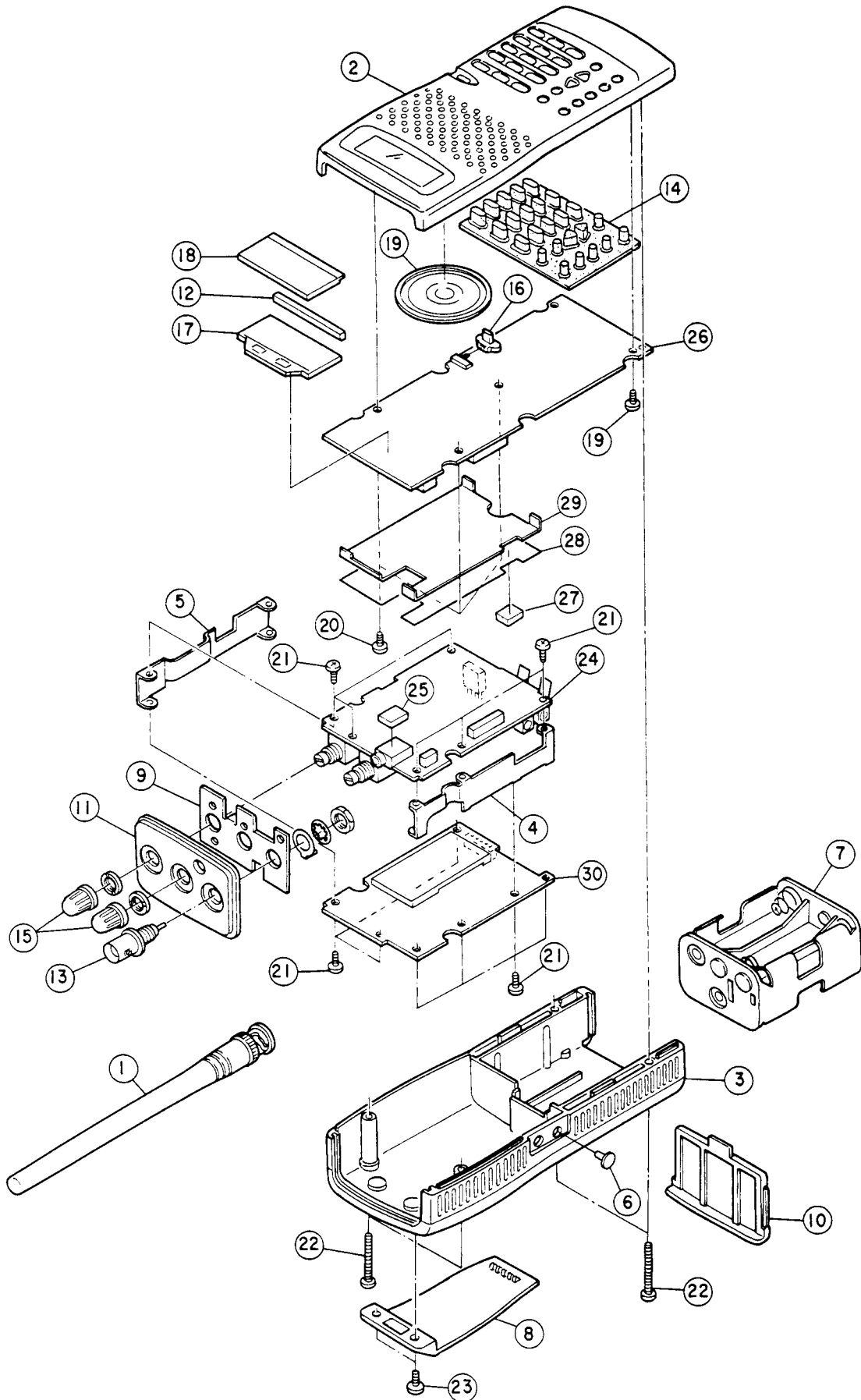

MECHANICAL PARTS LIST

Ref.No.	Description	RS Part No.	Mfr's Part No.
1	Antenna, Rubber		GE-91D-9447
2	Assembly, Case, Front (Non-Repairable)		GA-94D-1237
	Case, Front		GE-94A-1141
	Himelon, Speaker		GE-94D-1146
	Window, LCD		GE-94D-1144
3	Assembly, Case Rear		GA-94D-1297
	Case, Rear		GE-94A-1142
	Cushion, PLL Shield		GE-91D-9473
	Label, Model for USA		GE-94D-1230
4	Bracket, PCB (Antenna Side)		GE-94D-1147
5	Bracket, PCB (Volume Side)		GE-94D-1220
6	Cap, Charge Jack		GE-94D-1285
7	Case, Battery		GE-91D-9339
8	Clip, Belt		GE-94C-1158
9	Chassis, Top		GE-91D-9213
10	Cover, Battery		GE-91C-9217
11	Escutcheon, Top		GE-94C-1143
12	Interconnector, LCD		GE-94D-1178
13	Jack, Antenna		GE-85D-5383
14	Key Top		GE-94C-1145
15	Knob, Volume/Squelch		GE-93D-0816
16	Knob, Key Lock		GE-91D-9211
17	LCD		T240349
18	Reflector, LCD		GE-94D-1148
19	Speaker	8-ohm	500 mW Max.
	Wire Kit		USP-365N75
	Hardware Kit		#9409 (A)
			#9409 (B)
20	Screw, 2x3	Pan Head Machine	BLK (Zn)
21	Screw, 2x4	Pan Head Machine	(Ni)
22	Screw, 2.6x25	Pan Head Machine	BLK (Zn)
23	Screw, 3x5	Binding Head Machine	BLK (Zn)
			PM 2x3 BLK (Zn)
			PM 2x4 (Ni)
			PM 2.6x25 BLK (Zn)
			Bind 3x5 BLK (Zn)

ELECTRICAL PARTS LIST

AF PCB ASSEMBLY

Ref. No.	Description	RS Part No.	Mfr's Part No.
24	Assembly, PCB, AF Consists of the following:		GA-94D-1227
Capacitors			
C301	Ceramic 0.001 μ F \pm 10% 50 V 0603		ECUX1H102KV or CM105SL102K50A
C302	Ceramic 0.01 μ F \pm 10% 50 V 0603		ECUX1H103KBV or CM105X7R103K50A
C303	Ceramic 5 pF \pm 0.25 pF 50 V 0603		ECUX1H050CV or CM105SL050C50A
C304	Ceramic 5 pF \pm 0.25 pF 50 V 0603		ECUX1H050CV or CM105SL050C50A
C305	Ceramic 0.001 μ F \pm 10% 50 V 0603		ECUX1H102KV or CM105SL102K50A
C306	Ceramic 0.082 μ F \pm 10% 25 V 0805		CC20B1E823K or CM21X7R823K25A or TMK212BJ823K
C307	Tantalum 0.22 μ F \pm 20% 35 V		DN1VR22M1S
C308	Ceramic 0.082 μ F \pm 10% 25 V 0805		CC20B1E823K or CM21X7R823K25A or TMK212BJ823K
C309	Ceramic 33 pF \pm 10% 50 V 0603		ECUX1H330KV or CM105SL330K50A
C310	Ceramic 0.01 μ F \pm 10% 50 V 0603		ECUX1H103KBV or CM105X7R103K50A
C311	Ceramic 0.001 μ F \pm 10% 50 V 0603		ECUX1H102KV or CM105SL102K50A
C312	Ceramic 22 pF \pm 10% 50 V 0603		ECUX1H220KV or CM105SL220K50A
C313	Ceramic 0.001 μ F \pm 10% 50 V 0603		ECUX1H102KV or CM105SL102K50A
C314	Ceramic 33 pF \pm 10% 50 V 0603		ECUX1H330KV or CM105SL330K50A
C315	Ceramic 0.01 μ F \pm 10% 50 V 0603		ECUX1H103KBV or CM105X7R103K50A
C316	Electrolytic 10 μ F \pm 20% 16 V		16UTC M100M or SMB16V100M
C317	Ceramic 0.01 μ F \pm 10% 50 V 0603		ECUX1H103KBV or CM105X7R103K50A
C318	Ceramic 0.001 μ F \pm 10% 50 V 0603		ECUX1H102KV or CM105SL102K50A
C319	Ceramic 0.082 μ F \pm 10% 25 V 0805		CC20B1E823K or CM21X7R823K25A or TMK212BJ823K
C320	Ceramic 180 pF \pm 10% 50 V 0603		ECUX1H181KV or CM105SL181K50A
C321	Ceramic 180 pF \pm 10% 50 V 0603		ECUX1H181KV or CM105SL181K50A
C322	Ceramic 0.082 μ F \pm 10% 25 V 0805		CC20B1E823K or CM21X7R823K25A or TMK212BJ823K

Ref. No.	Description					RS Part No.	Mfr's Part No.
C323	Electrolytic	10 μ F	$\pm 20\%$	16 V			16UTCM100M or SMB16V100M
C324	Ceramic	0.01 μ F	$\pm 10\%$	50 V	0603		ECUX1H103KBV or CM105X7R103K50A
C325	Ceramic	0.01 μ F	$\pm 10\%$	50 V	0603		ECUX1H103KBV or CM105X7R103K50A
C326	Electrolytic	10 μ F	$\pm 20\%$	16 V			16UTCM100M or SMB16V100M
C327	Electrolytic	0.047 μ F	$\pm 20\%$	50 V			50UTCMR47M or SMB50VR47M
C328	Electrolytic	0.047 μ F	$\pm 20\%$	50 V			50UTCMR47M or SMB50VR47M
C329	Ceramic	0.01 μ F	$\pm 10\%$	50 V	0603		ECUX1H103KBV or CM105X7R103K50A
C330	Ceramic	220 pF	$\pm 10\%$	50 V	0603		ECUX1H221KV or CM105SL221K50A
C331	Ceramic	33 pF	$\pm 10\%$	50 V	0603		ECUX1H330KCV or CM105CH330K50A
C332	Ceramic	8 pF	± 0.5 pF	50 V	0603		ECUX1H080DCV or CM105CH080D50A
C333	Electrolytic	10 μ F	$\pm 20\%$	16 V			16UTCM100M or SMB16V100M
C334	Ceramic	0.01 μ F	$\pm 10\%$	50 V	0603		ECUX1H103KBV or CM105X7R103K50A
C335	Ceramic	0.001 μ F	$\pm 10\%$	50 V	0603		ECUX1H102KV or CM105SL102K50A
C336	Ceramic	0.082 μ F	$\pm 10\%$	25 V	0805		CC20B1E823K or CM21X7R823K25A or TMK212BJ823K
C337	Ceramic	0.0047 μ F	$\pm 10\%$	50 V	0603		ECUX1H472KBV or CM105X7R472K50A
C338	Ceramic	22 pF	$\pm 10\%$	50 V	0603		ECUX1H220KV or CM105SL220K50A
C339	Ceramic	56 pF	$\pm 10\%$	50 V	0603		ECUX1H560KV or CM105SL560K50A
C340	Ceramic	0.001 μ F	$\pm 10\%$	50 V	0603		ECUX1H102KV or CM105SL102K50A
C341	Ceramic	0.001 μ F	$\pm 10\%$	50 V	0603		ECUX1H102KV or CM105SL102K50A
C342	Ceramic	0.033 μ F	$\pm 10\%$	50 V	0805		ECUX1H333KBX or CM21X7R333K50A
C343	Ceramic	680 pF	$\pm 10\%$	50 V	0603		ECUX1H681KV or CM105SL681K50A
C344	Electrolytic	10 μ F	$\pm 20\%$	16 V			16UTCM100M or SMB16V100M
C345	Ceramic	0.015 μ F	$\pm 10\%$	50 V	0603		ECUX1H153KBV or CM105X7R153K50A
C346	Ceramic	0.082 μ F	$\pm 10\%$	25 V	0805		CC20B1E823K or CM21X7R823K25A
C347	Ceramic	0.082 μ F	$\pm 10\%$	25 V	0805		CC20B1E823K or CM21X7R823K25A or TMK212BJ823K

Ref. No.	Description					RS Part No.	Mfr's Part No.
C348	Ceramic	0.01 μ F	\pm 10%	50 V	0603		ECUX1H103KBV or CM105X7R103K50A
C349	Electrolytic	0.22 μ F	\pm 20%	50 V			50UTCMR22M or SMB50VR22M
C350	Electrolytic	4.7 μ F	\pm 20%	35 V			35UTCM4R7M or SMB35V4R7M
C351	Electrolytic	33 μ F	\pm 20%	16 V			16UTCMS330M or SMB16V330M
C352	Tantalum	10 μ F	\pm 20%	16 V			DN1C100M1S
C353	Electrolytic	470 μ F	\pm 20%	16 V			16UTES471M or ECA1CM471
C354	Electrolytic	47 μ F	\pm 20%	6.3 V			6.3UTCM470M or SMB6.3V470M or 10UTCMS470M or SMB10V470M
				or 10 V			
C355	Ceramic	0.082 μ F	\pm 10%	25 V	0805		CC20B1E823K or CM21X7R823K25A or TMK212BJ823K
C356	Ceramic	0.001 μ F	\pm 10%	50 V	0603		ECUX1H102KV or CM105SL102K50A
C357	Electrolytic	2.2 μ F	\pm 20%	50 V			50UTCM2R2M or SMB50V2R2M
C358	Electrolytic	4.7 μ F	\pm 20%	35 V			35UTCM4R7M or SMB35V4R7M
C359	Electrolytic	470 μ F	\pm 20%	16 V			16UTES471M or ECA1CM471
C360	Electrolytic	4.7 μ F	\pm 20%	35 V			35UTCM4R7M or SMB35V4R7M
C361	Electrolytic	10 μ F	\pm 20%	16 V			16UTCM100M or SMB16V100M
C362	Ceramic	0.0047 μ F	\pm 10%	50 V	0603		ECUX1H472KBV or CM105X7R472K50A
C363	Electrolytic	1 μ F	\pm 20%	50 V			50UTCM010M or SMB50V010M
C364	Ceramic	0.082 μ F	\pm 10%	25 V	0805		CC20B1E823K or CM21X7R823K25A or TMK212BJ823K
C365	Electrolytic	100 μ F	\pm 20%	16 V			16UTCM101M or SMB16V101M
C366	Ceramic	0.082 μ F	\pm 10%	25 V	0805		CC20B1E823K or CM21X7R823K25A or TMK212BJ823K
Ceramic Filters							
CF301	455 kHz						CFU455D2
CF302	10.7 MHz						SFE10.7MS2C10-A
CF303	10.7 MHz						SFE10.7MS2C10-A

Ref. No.	Description			RS Part No.	Mfr's Part No.
Diodes					
D301	DA227	Marked N20	Silicon Array		DA227
D302	HSU277	Marked 3	Silicon		HSU277
D303	HSU277	Marked 3	Silicon		HSU277
D304	DA227	Marked N20	Silicon Array		DA227
D305	DA227	Marked N20	Silicon Array		DA227
D306	HSU277	Marked 3	Silicon		HSU277
D307	RL1N4002		Silicon		RL1N4002
Integrated Circuits					
IC301	TA31136FN	3rd IF Amp/OSC/ Mixer/Noise Amp/Quad.	Bipolar SMT		TA31136FN
IC302	CX20111	3rd IF Amp/Mixer/ Detector	Bipolar SMT		CX20111
IC303	TC74HC4066AFS	Zeromatic/ Switching	MOS SMT		TC74HC4066AFS
IC304	BA10358F or NJM2904G or μ PC358G	Zeromatic	Bipolar SMT		BA10358F or NJM2904G or μ PC358G
IC305	TC7W139F	NFM/WFM/AM Control	MOS SMT		TC7W139F
IC306	LM386N-1 or NJM386BD	Audio Amp	Bipolar		LM386N-1 or NJM386BD
IC307	S-81250HG-RD	Voltage Regulator	CMOS SMT		S-81250HG-RD
IC308	TK11806M	DC-DC Converter	Bipolar SMT		TK11806M
IC309	TK10682M	Voltage Regulator Switching	Bipolar SMT		TK10682M
Coils					
L301	Coil,	Choke	1 μ H		LQH1N1R0M04
L302	Coil,	Choke	680 nH		LQH1NR68M04
L303	Coil,	Choke			GR-D835
L304	Filter, EMI Suppression				LC103N-1R0
Transistors					
Q301	2SC4116(Y)	Marked LY	NPN		2SC4116(Y)
Q302	DTC114YUA	Marked 64	NPN		DTC114YUA
Q303	DTC114YUA	Marked 64	NPN		DTC114YUA
Q304	DTA143ZUA	Marked 113	PNP		DTA143ZUA
Q305	2SC4215(O)	Marked QO	NPN		2SC4215(O)
Q306	DTC114YUA	Marked 64	NPN		DTC114YUA
Q307	2SC4116(GR)	Marked LG	NPN		2SC4116(GR)
Q308	DTC363EK	Marked H27	NPN		DTC363EK
Q309	DTC363EK	Marked H27	NPN		DTC363EK
Q310	DTC363EK	Marked H27	NPN		DTC363EK
Q311	2SC4116(GR)	Marked LG	NPN		2SC4116(GR)

Ref. No.	Description				RS Part No.	Mfr's Part No.
Resistors						
R301	Metal Glaze	10 kohm	±5%	1/16 W	0603	RK73K1J103J or CR10-103J
R302	Metal Glaze	560 ohm	±5%	1/16 W	0603	RK73K1J561J or CR10-561J
R303	Metal Glaze	10 kohm	±5%	1/16 W	0603	RK73K1J103J or CR10-103J
R304	Metal Glaze	10 kohm	±5%	1/16 W	0603	RK73K1J103J or CR10-103J
R305	Metal Glaze	560 ohm	±5%	1/16 W	0603	RK73K1J561J or CR10-561J
R306	Metal Glaze	1 kohm	±5%	1/16 W	0603	RK73K1J102J or CR10-102J
R307	Metal Glaze	1 Mohm	±5%	1/16 W	0603	RK73K1J105J or CR10-105J
R308	Metal Glaze	100 kohm	±5%	1/16 W	0603	RK73K1J104J or CR10-104J
R309	Metal Glaze	1 kohm	±5%	1/16 W	0603	RK73K1J102J or CR10-102J
R310	Metal Glaze	33 kohm	±5%	1/16 W	0603	RK73K1J333J or CR10-333J
R311	Metal Glaze	47 kohm	±5%	1/16 W	0603	RK73K1J473J or CR10-473J
R312	Metal Glaze	10 kohm	±5%	1/16 W	0603	RK73K1J103J or CR10-103J
R313	Metal Glaze	10 kohm	±5%	1/16 W	0603	RK73K1J103J or CR10-103J
R314	Metal Glaze	10 kohm	±5%	1/16 W	0603	RK73K1J103J or CR10-103J
R315	Not used					
R316	Metal Glaze	100 ohm	±5%	1/16 W	0603	RK73K1J101J or CR10-101J
R317	Metal Glaze	3.3 kohm	±5%	1/16W	0603	RK73K1J332J or CR10-332J
R318	Metal Glaze	2.2 kohm	±5%	1/16 W	0603	RK73K1J222J or CR10-222J
R319	Metal Glaze	100 kohm	±5%	1/16 W	0603	RK73K1J104J or CR10-104J
R320	Metal Glaze	2.2 kohm	±5%	1/16 W	0603	RK73K1J222J or CR10-222J
R321	Metal Glaze	220 kohm	±5%	1/16 W	0603	RK73K1J224J or CR10-224J
R322	Metal Glaze	15 kohm	±5%	1/16 W	0603	RK73K1J153J or CR10-153J
R323	Metal Glaze	100 ohm	±5%	1/16 W	0603	RK73K1J101J or CR10-101J
R324	Metal Glaze	10 kohm	±5%	1/16 W	0603	RK73K1J103J or CR10-103J
R325	Metal Glaze	1 kohm	±5%	1/16 W	0603	RK73K1J102J or CR10-102J

Ref. No.	Description	RS Part No.	Mfr's Part No.
R326	Metal Glaze 1.5 kohm ±5% 1/16 W 0603		RK73K1J152J or CR10-152J
R327	Metal Glaze 2.2 kohm ±5% 1/16 W 0603		RK73K1J222J or CR10-222J
R328	Metal Glaze 100 kohm ±5% 1/16 W 0603		RK73K1J104J or CR10-104J
R329	Metal Glaze 33 kohm ±5% 1/16 W 0603		RK73K1J333J or CR10-333J
R330	Metal Glaze 1 kohm ±5% 1/16 W 0603		RK73K1J102J or CR10-102J
R331	Metal Glaze 68 kohm ±5% 1/16 W 0603		RK73K1J683J or CR10-683J
R332	Metal Glaze 22 kohm ±5% 1/16 W 0603		RK73K1J223J or CR10-223J
R333	Metal Glaze 1 kohm ±5% 1/16 W 0603		RK73K1J102J or CR10-102J
R334	Metal Glaze 10 kohm ±5% 1/16 W 0603		RK73K1J103J or CR10-103J
R335	Metal Glaze 47 kohm ±5% 1/16 W 0603		RK73K1J473J or CR10-473J
R336	Metal Glaze 10 Mohm ±5% 1/16 W 0603		RK73K1J106J or CR10-106J
R337	Metal Glaze 470 kohm ±5% 1/16 W 0603		RK73K1J474J or CR10-474J
R338	Metal Glaze 22 kohm ±5% 1/16 W 0603		RK73K1J223J or CR10-223J
R339	Metal Glaze 22 kohm ±5% 1/16 W 0603		RK73K1J223J or CR10-223J
R340	Metal Glaze 27 kohm ±5% 1/16 W 0603		RK73K1J273J or CR10-273J
R341	Metal Glaze 1.5 kohm ±5% 1/16 W 0603		RK73K1J152J or CR10-152J
R342	Metal Glaze 9.1 kohm ±5% 1/16 W 0603		RK73K1J912J or CR10-912J
R343	Metal Glaze 12 kohm ±5% 1/16 W 0603		RK73K1J123J or CR10-123J
R344	Metal Glaze 3.3 kohm ±5% 1/16 W 0603		RK73K1J332J or CR10-332J
R345	Metal Glaze 15 kohm ±5% 1/16 W 0603		RK73K1J153J or CR10-153J
R346	Metal Glaze 10 kohm ±5% 1/16 W 0603		RK73K1J103J or CR10-103J
R347	Metal Glaze 470 kohm ±5% 1/16 W 0603		RK73K1J474J or CR10-474J
R348	Metal Glaze 4.7 kohm ±5% 1/16 W 0603		RK73K1J472J or CR10-472J
R349	Metal Glaze 1 kohm ±5% 1/16 W 0603		RK73K1J102J or CR10-102J
R350	Metal Glaze 5.6 kohm ±5% 1/16 W 0603		RK73K1J562J or CR10-562J
R351	Metal Glaze 22 kohm ±5% 1/16 W 0603		RK73K1J223J or CR10-223J

Ref. No.	Description	RS Part No.	Mfr's Part No.
R352	Metal Glaze 470 kohm ± 5% 1/16 W 0603		RK73K1J474J or CR10-474J
R353	Metal Glaze 220 ohm ± 5% 1/16 W 0603		RK73K1J221J or CR10-221J
R354	Metal Glaze 820 ohm ± 5% 1/16 W 0603		RK73K1J821J or CR10-821J
R355	Metal Glaze 47 ohm ± 5% 1/16 W 0603		RK73K1J470J or CR10-470J
R356	Metal Glaze 4.7 ohm ± 5% 1/4 W 1210		RK73M2E4R7J
R357	Metal Glaze 2.2 kohm ± 5% 1/16 W 0603		RK73K1J222J or CR10-222J
R358	Metal Glaze 1 Mohm ± 5% 1/16 W 0603		RK73K1J105J or CR10-105J
R359	Metal Glaze 10 kohm ± 5% 1/16 W 0603		RK73K1J103J or CR10-103J
R360	Metal Glaze 56 kohm ± 5% 1/16 W 0603		RK73K1J563J or CR10-563J
R361	Metal Glaze 56 kohm ± 5% 1/16 W 0603		RK73K1J563J or CR10-563J
R362	Metal Glaze 22 kohm ± 5% 1/16 W 0603		RK73K1J223J or CR10-223J
R363	Metal Glaze 4.7 kohm ± 5% 1/16 W 0603		RK73K1J472J or CR10-472J
R364	Metal Glaze 22 kohm ± 5% 1/16 W 0603		RK73K1J223J or CR10-223J
R365	Metal Glaze 33 ohm ± 5% 1/4 W 1210		RK73K2E330J
R366	Metal Glaze 10 ohm ± 5% 1/16 W 0603		RK73K1J100J or CR10-100J
R367	Metal Glaze 10 kohm ± 5% 1/16 W 0603		RK73K1J103J or CR10-103J
R368	Metal Glaze 330 ohm ± 5% 1/16 W 0603		RK73K1J331J or CR10-331J
R369	Carbon Film 22 ohm ± 5% 1/2 W		ERDS1TJ220
Transformers			
T301 T302	Assembly, PCB Coil, Discriminator (Non-Repairable) Coil Coil		GA-94D-1229 GR-E852 GR-F853
Crystals			
X301 X302	44.545 MHz 34.3 MHz		TR-1 44.545 MHz TR-49 34.3 MHz

Ref. No.	Description	RS Part No.	Mfr's Part No.
Crystal Filter			
XF301	45 MHz		TR-1(3) MF45R2 45 MHz
Miscellaneous			
CN301	Terminal, Battery Connector, 5-Pin Male		GE-91D-9218 174075-5
CN302	Connector, 10-Pin Female		52024-1010
CN303	Connector, 2-Pin Female		52024-0210
CN304	Connector, 2-Pin Male		IL-Y-2P-S15T2-EF
J301	Jack, Earphone		HSJ0836-01-500
J302	Jack, Power		HEC2711-01-620
J303	Jack, Charge		HEC2711-01-620
25	Pad, PCB		GE-92D-9623
TP301	Pin, Test		GE-87D-7290
GND	Pin, Test		GE-87D-7290
	Assembly, Squelch		GA-92D-9487
VR301	Potentiometer, Squelch, 10 kohm (C) Nut 7 mm Dia.		RK0971110-10KC-10 GE-89D-8343-1
	Assembly, Volume		GA-92D-9486
VR302	Potentiometer, Volume, 50 kohm (A) with Switch Nut 7 mm Dia.		RK0971111-50KA-10 GE-89D-8343-1

LOGIC PCB ASSEMBLY

Ref. No.	Description	RS Part No.	Mfr's Part No.
26	Assembly, PCB, Logic Consists of the following:		GA-94D-1228
Capacitors			
C1	Ceramic 0.01 μ F \pm 10% 50 V 0603		ECUX1H103KBV or CM105X7R103K50A
C2	Ceramic 0.001 μ F \pm 10% 50 V 0603		ECUX1H102KV or CM105SL102K50A
C3	Ceramic 0.001 μ F \pm 10% 50 V 0603		ECUX1H102KV or CM105SL102K50A
C4	Ceramic 0.001 μ F \pm 10% 50 V 0603		ECUX1H102KV or CM105SL102K50A
C5	Ceramic 0.001 μ F \pm 10% 50 V 0603		ECUX1H102KV or CM105SL102K50A
C6	Ceramic 0.001 μ F \pm 10% 50 V 0603		ECUX1H102KV or CM105SL102K50A
C7	Ceramic 0.001 μ F \pm 10% 50 V 0603		ECUX1H102KV or CM105SL102K50A
C8	Ceramic 0.001 μ F \pm 10% 50 V 0603		ECUX1H102KV or CM105SL102K50A
C9	Ceramic 0.001 μ F \pm 10% 50 V 0603		ECUX1H102KV or CM105SL102K50A
C10	Ceramic 0.001 μ F \pm 10% 50 V 0603		ECUX1H102KV or CM105SL102K50A
C11	Ceramic 0.001 μ F \pm 10% 50 V 0603		ECUX1H102KV or CM105SL102K50A
C12	Ceramic 0.001 μ F \pm 10% 50 V 0603		ECUX1H102KV or CM105SL102K50A
C13	Ceramic 0.001 μ F \pm 10% 50 V 0603		ECUX1H102KV or CM105SL102K50A
C14	Ceramic 0.001 μ F \pm 10% 50 V 0603		ECUX1H102KV or CM105SL102K50A
C15	Ceramic 0.001 μ F \pm 10% 50 V 0603		ECUX1H102KV or CM105SL102K50A
C16	Ceramic 0.001 μ F \pm 10% 50 V 0603		ECUX1H102KV or CM105SL102K50A
C17	Ceramic 0.001 μ F \pm 10% 50 V 0603		ECUX1H102KV or CM105SL102K50A
C18	Ceramic 0.001 μ F \pm 10% 50 V 0603		ECUX1H102KV or CM105SL102K50A
C19	Ceramic 0.001 μ F \pm 10% 50 V 0603		ECUX1H102KV or CM105SL102K50A
C20	Ceramic 0.001 μ F \pm 10% 50 V 0603		ECUX1H102KV or CM105SL102K50A
C21	Ceramic 0.001 μ F \pm 10% 50 V 0603		ECUX1H102KV or CM105SL102K50A
C22	Ceramic 0.001 μ F \pm 10% 50 V 0603		ECUX1H102KV or CM105SL102K50A
C23	Ceramic 47 pF \pm 10% 50 V 0603		ECUX1H470KV or CM105SL470K50A
C25	Ceramic 47 pF \pm 10% 50 V 0603		ECUX1H470KV or CM105SL470K50A

Ref. No.	Description					RS Part No.	Mfr's Part No.
C26	Ceramic	47 pF	±10%	50 V	0603		ECUX1H470KV or CM105SL470K50A
C27	Ceramic	47 pF	±10%	50 V	0603		ECUX1H470KV or CM105SL470K50A
C28	Ceramic	47 pF	±10%	50 V	0603		ECUX1H470KV or CM105SL470K50A
C29	Ceramic	47 pF	±10%	50 V	0603		ECUX1H470KV or CM105SL470K50A
C30	Ceramic	47 pF	±10%	50 V	0603		ECUX1H470KV or CM105SL470K50A
C31	Ceramic	100 pF	±10%	50 V	0603		ECUX1H101KV or CM105SL101K50A
C32	Ceramic	100 pF	±10%	50 V	0603		ECUX1H101KV or CM105SL101K50A
C33	Ceramic	100 pF	±10%	50 V	0603		ECUX1H101KV or CM105SL101K50A
C34	Ceramic	100 pF	±10%	50 V	0603		ECUX1H101KV or CM105SL101K50A
C35	Ceramic	100 pF	±10%	50 V	0603		ECUX1H101KV or CM105SL101K50A
C36	Ceramic	100 pF	±10%	50 V	0603		ECUX1H101KV or CM105SL101K50A
C37	Ceramic	0.01 μF	±10%	50 V	0603		ECUX1H103KBV or CM105X7R103K50A
C38	Ceramic	0.01 μF	±10%	50 V	0603		ECUX1H103KBV or CM105X7R103K50A
C39	Ceramic	0.001 μF	±10%	50 V	0603		ECUX1H102KV or CM105SL102K50A
C40	Ceramic	0.001 μF	±10%	50 V	0603		ECUX1H102KV or CM105SL102K50A
C41	Ceramic	0.001 μF	±10%	50 V	0603		ECUX1H102KV or CM105SL102K50A
C42	Ceramic	0.001 μF	±10%	50 V	0603		ECUX1H102KV or CM105SL102K50A
C43	Ceramic	0.001 μF	±10%	50 V	0603		ECUX1H102KV or CM105SL102K50A
C44	Ceramic	0.001 μF	±10%	50 V	0603		ECUX1H102KV or CM105SL102K50A
C45	Ceramic	0.001 μF	±10%	50 V	0603		ECUX1H102KV or CM105SL102K50A
C46	Ceramic	0.001 μF	±10%	50 V	0603		ECUX1H102KV or CM105SL102K50A
C47	Ceramic	0.001 μF	±10%	50 V	0603		ECUX1H102KV or CM105SL102K50A
C48	Ceramic	0.001 μF	±10%	50 V	0603		ECUX1H102KV or CM105SL102K50A
C49	Ceramic	0.001 μF	±10%	50 V	0603		ECUX1H102KV or CM105SL102K50A
C50	Ceramic	0.001 μF	±10%	50 V	0603		ECUX1H102KV or CM105SL102K50A

Ref. No.	Description				RS Part No.	Mfr's Part No.
Ceramic Resonator						
CX1	4.19 MHz					EFO-V4194B5
Diodes						
D1	MA121	Marked M2D	Silicon			MA121
D2	MA121	Marked M2D	Silicon			MA121
D3	1SS272	Marked A1	Silicon			1SS272
	or 1SS306	Marked A3	Silicon			or 1SS306
D4	HSU277	Marked 3	Silicon			HSU277
Integrated Circuits						
IC1	GRE-9409	Microprocessor 8-bit	MOS	SMT		GRE-9409
IC2	XL93LC66RF	Memory	CMOS	SMT		XL93LC66RF
	or NM93C66LM8					or NM93C66LM8
IC3	XL93LC66RF	Memory	CMOS	SMT		XL93LC66RF
	or NM93C66LM8					or NM93C66LM8
IC4	S80737AL-A1	Voltage Regulator	CMOS	SMT		S80737AL-A1
IC5	S80744AL-A8	Low Battery Detector	CMOS	SMT		S80744AL-A8
Coil						
L1	Filter, EMI Suppression					NFM41R10C223B1
LEDs						
LED1						LT1E51A
LED2						LT1E51A
Transistor						
Q1	DTC114YUA	Marked 64	NPN			DTC114YUA
Resistors						
R1	Metal Glaze	1 kohm	±5%	1/16 W	0603	RK73K1J102J
						or CR10-102J
R2	Metal Glaze	15 kohm	±5%	1/16 W	0603	RK73K1J153J
						or CR10-153J
R3	Metal Glaze	100 kohm	±5%	1/16 W	0603	RK73K1J104J
						or CR10-104J
R4	Metal Glaze	100 kohm	±5%	1/16 W	0603	RK73K1J104J
						or CR10-104J

Ref. No.	Description	RS Part No.	Mfr's Part No.
R5	Metal Glaze 1 kohm $\pm 5\%$ 1/16 W 0603		RK73K1J102J or CR10-102J
R6	Metal Glaze 1 kohm $\pm 5\%$ 1/16 W 0603		RK73K1J102J or CR10-102J
R7	Metal Glaze 47 kohm $\pm 5\%$ 1/16 W 0603		RK73K1J473J or CR10-473J
R8	Metal Glaze 56 ohm $\pm 5\%$ 1/16 W 0603		RK73K1J560J or CR10-560J
R9	Metal Glaze 47 kohm $\pm 5\%$ 1/16 W 0603		RK73K1J473J or CR10-473J
Resistor Arrays			
RA1	Metal Glaze 1 kohm x 4 $\pm 5\%$ 1/16 W		CN1J4102J
RA2	Metal Glaze 1 kohm x 4 $\pm 5\%$ 1/16 W		CN1J4102J
RA3	Metal Glaze 1 kohm x 4 $\pm 5\%$ 1/16 W		CN1J4102J
RA4	Metal Glaze 1 kohm x 4 $\pm 5\%$ 1/16 W		CN1J4102J
RA5	Metal Glaze 470 ohm x 4 $\pm 5\%$ 1/16 W		CN1J4471J
RA6	Metal Glaze 1 kohm x 4 $\pm 5\%$ 1/16 W		CN1J4102J
RA7	Metal Glaze 1 kohm x 4 $\pm 5\%$ 1/16 W		CN1J4102J
RA8	Metal Glaze 1 kohm x 4 $\pm 5\%$ 1/16 W		CN1J4102J
RA9	Metal Glaze 1 kohm x 4 $\pm 5\%$ 1/16 W		CN1J4102J
RA10	Metal Glaze 1 kohm x 4 $\pm 5\%$ 1/16 W		CN1J4102J
Miscellaneous			
CN3	Connector, 10-Pin Male		53022-1010
CN4	Connector, 2-Pin Male		53022-0210
SW1	Switch, Slide (Key Lock)		SSSS7-12-ZA
27	Cushion, PLL Shield		GE-91D-9473
28	Fiber, Logic Shield		GE-91D-9338
29	Plate, Logic Shield		GE-91D-9220

RF PCB ASSEMBLY

Ref. No.	Description					RS Part No.	Mfr's Part No.
30	Assembly, PCB, RF						GA-94D-1226
	Consists of the following:						
Capacitors							
C101	Ceramic	0.001 μ F	\pm 10%	50 V	0603		ECUX1H102KV or CM105SL102K50A
C102	Ceramic	7 pF	\pm 0.5 pF	50 V	0603		ECUX1H070DV or CM105SL070D50A
C103	Ceramic	3 pF	\pm 0.25 pF	50 V	0603		ECUX1H030CV or CM105SL030C50A
C104	Ceramic	3 pF	\pm 0.25 pF	50 V	0603		ECUX1H030CV or CM105SL030C50A
C105	Ceramic	5 pF	\pm 0.25 pF	50 V	0603		ECUX1H050CV or CM105SL050C50A
C106	Ceramic	0.001 μ F	\pm 10%	50 V	0603		ECUX1H102KV or CM105SL102K50A
C107	Electrolytic	1 μ F	\pm 20%	50 V			50UTCX010M or SMM50V010M
C108	Ceramic	0.001 μ F	\pm 10%	50 V	0603		ECUX1H102KV or CM105SL102K50A
C109	Ceramic	22 pF	\pm 10%	50 V	0603		ECUX1H220KV or CM105SL220K50A
C110	Ceramic	4 pF	\pm 0.25 pF	50 V	0603		ECUX1H040CV or CM105SL040C50A
C111	Ceramic	2 pF	\pm 0.25 pF	50 V	0603		ECUX1H020CV or CM105SL020C50A
C112	Ceramic	3 pF	\pm 0.25 pF	50 V	0603		ECUX1H030CV or CM105SL030C50A
C113	Ceramic	3 pF	\pm 0.25 pF	50 V	0603		ECUX1H030CV or CM105SL030C50A
C114	Ceramic	7 pF	\pm 0.5 pF	50 V	0603		ECUX1H070DV or CM105SL070D50A
C115	Ceramic	5 pF	\pm 0.25 pF	50 V	0603		ECUX1H050CV or CM105SL050C50A
C116	Ceramic	0.001 μ F	\pm 10%	50 V	0603		ECUX1H102KV or CM105SL102K50A
C117	Electrolytic	1 μ F	\pm 20%	50 V			50UTCX010M or SMM50V010M
C118	Ceramic	0.001 μ F	\pm 10%	50 V	0603		ECUX1H102KV or CM105SL102K50A
C119	Ceramic	27 pF	\pm 10%	50 V	0603		ECUX1H270KV or CM105SL270K50A
C120	Ceramic	12 pF	\pm 10%	50 V	0603		ECUX1H120KV or CM105SL120K50A
C121	Ceramic	18 pF	\pm 10%	50 V	0603		ECUX1H180KV or CM105SL180K50A
C122	Ceramic	18 pF	\pm 10%	50 V	0603		ECUX1H180KV or CM105SL180K50A
C123	Ceramic	27 pF	\pm 10%	50 V	0603		ECUX1H270KV or CM105SL270K50A
C124	Ceramic	7 pF	\pm 0.5 pF	50 V	0603		ECUX1H070DV or CM105SL070D50A

Ref. No.	Description					RS Part No.	Mfr's Part No.
C125	Ceramic	0.001 μ F	$\pm 10\%$	50 V	0603		ECUX1H102KV or CM105SL102K50A
C126	Electrolytic	1 μ F	$\pm 20\%$	50 V			50UTCX010M or SMM50V010M
C127	Ceramic	0.001 μ F	$\pm 10\%$	50 V	0603		ECUX1H102KV or CM105SL102K50A
C128	Ceramic	33 pF	$\pm 10\%$	50 V	0603		ECUX1H330KV or CM105SL330K50A
C129	Ceramic	22 pF	$\pm 10\%$	50 V	0603		ECUX1H220KV or CM105SL220K50A
C130	Ceramic	33 pF	$\pm 10\%$	50 V	0603		ECUX1H330KV or CM105SL330K50A
C131	Ceramic	47 pF	$\pm 10\%$	50 V	0603		ECUX1H470KV or CM105SL470K50A
C132	Ceramic	27 pF	$\pm 10\%$	50 V	0603		ECUX1H270KV or CM105SL270K50A
C133	Ceramic	0.001 μ F	$\pm 10\%$	50 V	0603		ECUX1H102KV or CM105SL102K50A
C134	Electrolytic	1 μ F	$\pm 20\%$	50 V			50UTCX010M or SMM50V010M
C135	Ceramic	0.001 μ F	$\pm 10\%$	50 V	0603		ECUX1H102KV or CM105SL102K50A
C136	Ceramic	100 pF	$\pm 10\%$	50 V	0603		ECUX1H101KV or CM105SL101K50A
C137	Ceramic	100 pF	$\pm 10\%$	50 V	0603		ECUX1H101KV or CM105SL101K50A
C138	Ceramic	56 pF	$\pm 10\%$	50 V	0603		ECUX1H560KV or CM105SL560K50A
C139	Ceramic	82 pF	$\pm 10\%$	50 V	0603		ECUX1H820KV or CM105SL820K50A
C140	Ceramic	56 pF	$\pm 10\%$	50 V	0603		ECUX1H560KV or CM105SL560K50A
C141	Ceramic	0.001 μ F	$\pm 10\%$	50 V	0603		ECUX1H102KV or CM105SL102K50A
C142	Electrolytic	1 μ F	$\pm 20\%$	50 V			50UTCX010M or SMM50V010M
C143	Ceramic	0.001 μ F	$\pm 10\%$	50 V	0603		ECUX1H102KV or CM105SL102K50A
C144	Not used						
C145	Ceramic	22 pF	$\pm 10\%$	50 V	0603		ECUX1H220KV or CM105SL220K50A
C146	Not used						
C147	Ceramic	330 pF	$\pm 10\%$	50 V	0603		ECUX1H331KV or CM105SL331K50A
C148	Ceramic	10 pF	± 0.5 pF	50 V	0603		ECUX1H100DV or CM105SL100D50A
C149	Ceramic	0.001 μ F	$\pm 10\%$	50 V	0603		ECUX1H102KV or CM105SL102K50A
C150	Ceramic	3 pF	± 0.25 pF	50 V	0603		ECUX1H030CV or CM105SL030C50A
C151	Ceramic	0.001 μ F	$\pm 10\%$	50 V	0603		ECUX1H102KV or CM105SL102K50A

Ref. No.	Description					RS Part No.	Mfr's Part No.
C152	Ceramic	0.001 μ F	$\pm 10\%$	50 V	0603		ECUX1H102KV or CM105SL102K50A
C153	Ceramic	0.001 μ F	$\pm 10\%$	50 V	0603		ECUX1H102KV or CM105SL102K50A
C154	Ceramic	0.01 μ F	$\pm 10\%$	50 V	0603		ECUX1H103KBV or CM105X7R103K50A
C155	Not used						
C156	Ceramic	0.001 μ F	$\pm 10\%$	50 V	0603		ECUX1H102KV or CM105SL102K50A
C157	Not used						
C158	Ceramic	0.001 μ F	$\pm 10\%$	50 V	0603		ECUX1H102KV or CM105SL102K50A
C159	Not used						
C160	Ceramic	47 pF	$\pm 10\%$	50 V	0603		ECUX1H470KV or CM105SL470K50A
C161	Not used						
C162	Ceramic	2 pF	± 0.25 pF	50 V	0603		ECUX1H020CV or CM105SL020C50A
C163	Ceramic	0.001 μ F	$\pm 10\%$	50 V	0603		ECUX1H102KV or CM105SL102K50A
C164	Ceramic	22 pF	$\pm 10\%$	50 V	0603		ECUX1H220KV or CM105SL220K50A
C165	Not used						
C166	Ceramic	22 pF	$\pm 10\%$	50 V	0603		ECUX1H220KV or CM105SL220K50A
C167	Ceramic	5 pF	± 0.25 pF	50 V	0603		ECUX1H050CV or CM105SL050C50A
C168	Ceramic	0.001 μ F	$\pm 10\%$	50 V	0603		ECUX1H102KV or CM105SL102K50A
C169	Ceramic	100 pF	$\pm 10\%$	50 V	0603		ECUX1H101KV or CM105SL101K50A
C170	Ceramic	1 pF	± 0.25 pF	50 V	0603		ECUX1H010CV or CM105SL010C50A
C171	Ceramic	1 pF	± 0.25 pF	50 V	0603		ECUX1H010CV or CM105SL010C50A
C172	Ceramic	2 pF	± 0.25 pF	50 V	0603		ECUX1H020CV or CM105SL020C50A
C173	Ceramic	47 pF	$\pm 10\%$	50 V	0603		ECUX1H470KV or CM105SL470K50A
C174	Ceramic	22 pF	$\pm 10\%$	50 V	0603		ECUX1H220KV or CM105SL220K50A
C175	Ceramic	22 pF	$\pm 10\%$	50 V	0603		ECUX1H220KV or CM105SL220K50A
C176	Ceramic	2 pF	± 0.25 pF	50 V	0603		ECUX1H020CV or CM105SL020C50A
C177	Ceramic	1 pF	± 0.25 pF	50 V	0603		ECUX1H010CV or CM105SL010C50A
C178	Ceramic	22 pF	$\pm 10\%$	50 V	0603		ECUX1H220KV or CM105SL220K50A
C179	Ceramic	22 pF	$\pm 10\%$	50 V	0603		ECUX1H220KV or CM105SL220K50A

Ref. No.	Description				RS Part No.	Mfr's Part No.
C180	Ceramic	1 pF	±0.25 pF	50 V	0603	ECUX1H010CV or CM105SL010C50A
C181	Ceramic	0.001 μF	±10%	50 V	0603	ECUX1H102KV or CM105SL102K50A
C182	Ceramic	150 pF	±10%	50 V	0603	ECUX1H151KV or CM105SL151K50A
C183	Ceramic	0.082 μF	±10%	25 V	0805	CC20B1E823K or CM21X7R823K25A or TMK212BJ823K
C184	Mylar*	0.01 μF	±10%	50 V		NNM-103K
C185	Ceramic	0.001 μF	±10%	50 V	0603	ECUX1H102KV or CM105SL102K50A
C186	Ceramic	0.001 μF	±10%	50 V	0603	ECUX1H102KV or CM105SL102K50A
C187	Ceramic	0.001 μF	±10%	50 V	0603	ECUX1H102KV or CM105SL102K50A
C188	Ceramic	10 pF	±0.5 pF	50 V	0603	ECUX1H100DV or CM105SL100D50A
C189	Ceramic	0.001 μF	±10%	50 V	0603	ECUX1H102KV or CM105SL102K50A
C190	Electrolytic	10 μF	±20%	16 V		16UTCX100M or SMM16V100M
C191	Ceramic	47 pF	±10%	50 V	0603	ECUX1H470KV or CM105SL470K50A
C192	Ceramic	47 pF	±10%	50 V	0603	ECUX1H470KV or CM105SL470K50A
C193	Ceramic	47 pF	±10%	50 V	0603	ECUX1H470KV or CM105SL470K50A
C194	Ceramic	47 pF	±10%	50 V	0603	ECUX1H470KV or CM105SL470K50A
C195	Ceramic	12 pF	±10%	50 V	0603	ECUX1H120KV or CM105SL120K50A
C196	Ceramic	10 pF	±0.5 pF	50 V	0603	ECUX1H100DV or CM105SL100D50A
C197	Ceramic	6 pF	±0.5 pF	50 V	0603	ECUX1H060DV or CM105SL060D50A
C198	Ceramic	0.001 μF	±10%	50 V	0603	ECUX1H102KV or CM105SL102K50A
C199	Electrolytic	10 μF	±20%	16 V		16UTCX100M or SMM16V100M
C200	Ceramic	5 pF	±0.25 pF	50 V	0603	ECUX1H050CV or CM105SL050C50A
C201	Ceramic	18 pF	±10%	50 V	0603	ECUX1H180KCV or CM105CH180K50A
C202	Ceramic	33 pF	±10%	50 V	0603	ECUX1H330KCV or CM105CH330K50A
C203	Ceramic	0.01 μF	±10%	50 V	0603	ECUX1H103KBV or CM105X7R103K50A
C204	Mylar	0.022 μF	±10%	50 V		AMC223K50V
C205	Mylar	0.047 μF	±10%	50 V		AMC473K50V

*Mylar is a registered trademark of E.I. DuPont de Nemours and Company.

Ref. No.	Description					RS Part No.	Mfr's Part No.
C206	Tantalum	0.47 μ F	\pm 20%	35 V			DN1VR47M1S
C207	Ceramic	0.001 μ F	\pm 10%	50 V	0603		ECUX1H102KV or CM105SL102K50A
C208	Ceramic	100 pF	\pm 10%	50 V	0603		ECUX1H101KV or CM105SL101K50A
C209	Ceramic	10 pF	\pm 0.5 pF	50 V	0603		ECUX1H100DV or CM105SL100D50A
C210	Ceramic	10 pF	\pm 0.5 pF	50 V	0603		ECUX1H100DV or CM105SL100D50A
C211	Ceramic	0.001 μ F	\pm 10%	50 V	0603		ECUX1H102KV or CM105SL102K50A
C212	Ceramic	0.001 μ F	\pm 10%	50 V	0603		ECUX1H102KV or CM105SL102K50A
C213	Ceramic	0.001 μ F	\pm 10%	50 V	0603		ECUX1H102KV or CM105SL102K50A
C214	Ceramic	0.001 μ F	\pm 10%	50 V	0603		ECUX1H102KV or CM105SL102K50A
C215	Mylar	0.0047 μ F	\pm 10%	50 V			AMC472K50V
Diodes							
D101	HSM2693A	Marked B4		Silicon			HSM2693A
D102	HSU277	Marked 3		Silicon			HSU277
D103	HSU277	Marked 3		Silicon			HSU277
D104	HSU277	Marked 3		Silicon			HSU277
D105	HSU277	Marked 3		Silicon			HSU277
D106	HSM2693A	Marked B4		Silicon			HSM2693A
D107	HSU277	Marked 3		Silicon			HSU277
D108	HSU277	Marked 3		Silicon			HSU277
D109	HSU277	Marked 3		Silicon			HSU277
D110	HSU277	Marked 3		Silicon			HSU277
D111	HSU277	Marked 3		Silicon			HSU277
D112	HSU277	Marked 3		Silicon			HSU277
D113	HSM2693A	Marked B4		Silicon			HSM2693A
D114	HSM2693A	Marked B4		Silicon			HSM2693A
D115	ND433G	Schottky Barrier		Silicon			ND433G
D116	HVU306A	Marked 3		Silicon	Varactor		HVU306A
D117	HVU306A	Marked 3		Silicon	Varactor		HVU306A
D118	HVU306A	Marked 3		Silicon	Varactor		HVU306A
D119	HVU306A	Marked 3		Silicon	Varactor		HVU306A
D120	HVU12	Marked A		Silicon	Varactor		HVU12
D121	HVU308	Marked 8		Silicon	Varactor		HVU308
Integrated Circuits							
IC101	CXA1356N	PLL	Bipolar	SMT			CXA1356N
IC102	MB1512PFV-G	PLL	CMOS	SMT			MB1512PFV-G
Coils							
L101	Choke	1 μ H					LQH1N1R0M04
L102	BPF	(760-999.9875 MHz)					LL2012-F4N7K

Ref. No.	Description			RS Part No.	Mfr's Part No.
L103	BPF	(760-999.9875 MHz)			LL2012-F4N7K
L104	BPF	(760-999.9875 MHz)			LL2012-F4N7K
L105	BPF	(380-512 MHz)			LL2012-F22NK
L106	BPF	(380-512 MHz)			LL2012-F22NK
L107	BPF	(380-512 MHz)			LL2012-F33NK
L108	BPF	(380-512 MHz)			LL2012-F33NK
L109	BPF	(174.005-380 MHz)			LL2012-F22NK
L110	BPF	(174.005-380 MHz)			LL2012-F22NK
L111	BPF	(174.005-380 MHz)			LL2012-F22NK
L112	BPF	(174.005-380 MHz)			LL2012-F22NK
L113	BPF	(87.5-174 MHz)			LL2012-F56NK
L114	BPF	(87.5-174 MHz)			LL2012-F56NK
L115	BPF	(87.5-174 MHz)			LL2012-F56NK
L116	BPF	(30-87.495 MHz)			LQH1NR22M04
L117	BPF	(30-87.495 MHz)			LQN1AR10J04
L118	BPF	(30-87.495 MHz)			LQN1AR10J04
L119	Trap	First IF			2LNB-253
L120	RF				2LNR-316
L121	DBM				2LNM-258
L122	DBM				2LNM-258
L123	Stripline on PCB (IF Amp)				
L124	Not used				
L125	VCO				2LNB-253
L126	Choke	220 nH			LQH1NR22M04
L127	Stripline on PCB (VCO)				
L128	VCO				2LNO-254
L129	Filter, EMI Suppression				LC103N-1R0
L130	Filter, EMI Suppression				LC103N-1R0
L131	Choke	3.3 μ H			LQH1N3R3M04
Transistors					
Q101	DTA143ZUA	Marked 113	PNP		DTA143ZUA
Q102	UMA9N	Marked A9	PNP		UMA9N
Q103	UMA9N	Marked A9	PNP		UMA9N
Q104	2SC4226(R25)	Marked R25	NPN		2SC4226(R25)
Q105	2SC4226(R25)	Marked R25	NPN		2SC4226(R25)
Q106	2SC4226(R25)	Marked R25	NPN		2SC4226(R25)
Q107	2SC4215(O)	Marked QO	NPN		2SC4215(O)
Q108	2SC4226(R25)	Marked R25	NPN		2SC4226(R25)
Q109	2SC4226(R25)	Marked R25	NPN		2SC4226(R25)
Q110	2SC4226(R25)	Marked R25	NPN		2SC4226(R25)
Q111	DTC114YUA	Marked 64	NPN		DTC114YUA
Q112	2SC4226(R25)	Marked R25	NPN		2SC4226(R25)
Q113	2SC4226(R25)	Marked R25	NPN		2SC4226(R25)
Q114	DTC114YUA	Marked 64	NPN		DTC114YUA
Q115	2SC2712(GR)	Marked LG	NPN		2SC2712(GR)
Q116	2SK209(GR)	Marked XG	MOS	FET	2SK209(GR)
Q117	2SC4226(R25)	Marked R25	NPN		2SC4226(R25)
Q118	2SC4226(R25)	Marked R25	NPN		2SC4226(R25)

Ref. No.	Description	RS Part No.	Mfr's Part No.
Resistors			
R101	Metal Glaze 3.3 kohm ±5% 1/16 W 0603		RK73K1J332J or CR10-332J
R102	Metal Glaze 470 kohm ±5% 1/16 W 0603		RK73K1J474J or CR10-474J
R103	Metal Glaze 470 kohm ±5% 1/16 W 0603		RK73K1J474J or CR10-474J
R104	Metal Glaze 470 kohm ±5% 1/16 W 0603		RK73K1J474J or CR10-474J
R105	Metal Glaze 470 kohm ±5% 1/16 W 0603		RK73K1J474J or CR10-474J
R106	Metal Glaze 2.2 kohm ±5% 1/16 W 0603		RK73K1J222J or CR10-222J
R107	Metal Glaze 10 kohm ±5% 1/16 W 0603		RK73K1J103J or CR10-103J
R108	Metal Glaze 220 ohm ±5% 1/16 W 0603		RK73K1J221J or CR10-221J
R109	Metal Glaze 2.2 kohm ±5% 1/16 W 0603		RK73K1J222J or CR10-222J
R110	Metal Glaze 470 kohm ±5% 1/16 W 0603		RK73K1J474J or CR10-474J
R111	Metal Glaze 470 kohm ±5% 1/16 W 0603		RK73K1J474J or CR10-474J
R112	Metal Glaze 470 kohm ±5% 1/16 W 0603		RK73K1J474J or CR10-474J
R113	Metal Glaze 470 kohm ±5% 1/16 W 0603		RK73K1J474J or CR10-474J
R114	Metal Glaze 1.5 kohm ±5% 1/16 W 0603		RK73K1J152J or CR10-152J
R115	Metal Glaze 470 kohm ±5% 1/16 W 0603		RK73K1J474J or CR10-474J
R116	Metal Glaze 470 kohm ±5% 1/16 W 0603		RK73K1J474J or CR10-474J
R117	Metal Glaze 2.2 kohm ±5% 1/16 W 0603		RK73K1J222J or CR10-222J
R118	Metal Glaze 10 kohm ±5% 1/16 W 0603		RK73K1J103J or CR10-103J
R119	Metal Glaze 220 ohm ±5% 1/16 W 0603		RK73K1J221J or CR10-221J
R120	Metal Glaze 2.2 kohm ±5% 1/16 W 0603		RK73K1J222J or CR10-222J
R121	Metal Glaze 470 kohm ±5% 1/16 W 0603		RK73K1J474J or CR10-474J
R122	Metal Glaze 470 kohm ±5% 1/16 W 0603		RK73K1J474J or CR10-474J
R123	Metal Glaze 2.2 kohm ±5% 1/16 W 0603		RK73K1J222J or CR10-222J
R124	Metal Glaze 10 kohm ±5% 1/16 W 0603		RK73K1J103J or CR10-103J
R125	Metal Glaze 220 ohm ±5% 1/16 W 0603		RK73K1J221J or CR10-221J

Ref. No.	Description	RS Part No.	Mfr's Part No.
R126	Metal Glaze 2.2 kohm ±5% 1/16 W 0603		RK73K1J222J or CR10-222J
R127	Metal Glaze 470 kohm ±5% 1/16 W 0603		RK73K1J474J or CR10-474J
R128	Metal Glaze 470 kohm ±5% 1/16 W 0603		RK73K1J474J or CR10-474J
R129	Metal Glaze 2.2 kohm ±5% 1/16 W 0603		RK73K1J222J or CR10-222J
R130	Metal Glaze 10 kohm ±5% 1/16 W 0603		RK73K1J103J or CR10-103J
R131	Metal Glaze 220 ohm ±5% 1/16 W 0603		RK73K1J221J or CR10-221J
R132	Metal Glaze 2.2 kohm ±5% 1/16 W 0603		RK73K1J222J or CR10-222J
R133	Metal Glaze 2.2 kohm ±5% 1/16 W 0603		RK73K1J222J or CR10-222J
R134	Metal Glaze 10 kohm ±5% 1/16 W 0603		RK73K1J103J or CR10-103J
R135	Metal Glaze 220 ohm ±5% 1/16 W 0603		RK73K1J221J or CR10-221J
R136	Metal Glaze 2.2 kohm ±5% 1/16 W 0603		RK73K1J222J or CR10-222J
R137	Metal Glaze 47 ohm ±5% 1/16 W 0603		RK73K1J470J or CR10-470J
R138	Metal Glaze 47 kohm ±5% 1/16 W 0603		RK73K1J473J or CR10-473J
R139	Metal Glaze 100 ohm ±5% 1/16 W 0603		RK73K1J101J or CR10-101J
R140	Metal Glaze 10 kohm ±5% 1/16 W 0603		RK73K1J103J or CR10-103J
R141	Metal Glaze 4.7 kohm ±5% 1/16 W 0603		RK73K1J472J or CR10-472J
R142	Metal Glaze 100 ohm ±5% 1/16 W 0603		RK73K1J101J or CR10-101J
R143	Metal Glaze 10 kohm ±5% 1/16 W 0603		RK73K1J103J or CR10-103J
R144	Metal Glaze 470 ohm ±5% 1/16 W 0603		RK73K1J471J or CR10-471J
R145	Metal Glaze 330 ohm ±5% 1/16 W 0603		RK73K1J331J or CR10-331J
R146	Metal Glaze 10 kohm ±5% 1/16 W 0603		RK73K1J103J or CR10-103J
R147	Not used		
R148	Not used		
R149	Not used		
R150	Not used		
R151	Metal Glaze 220 kohm ±5% 1/16 W 0603		RK73K1J224J or CR10-224J
R152	Metal Glaze 47 kohm ±5% 1/16 W 0603		RK73K1J473J or CR10-473J
R153	Metal Glaze 47 ohm ±5% 1/16 W 0603		RK73K1J470J or CR10-470J

Ref. No.	Description	RS Part No.	Mfr's Part No.
R154	Metal Glaze 220 ohm ±5% 1/16 W 0603		RK73K1J221J or CR10-221J
R155	Metal Glaze 100 kohm ±5% 1/16 W 0603		RK73K1J104J or CR10-104J
R156	Metal Glaze 1 kohm ±5% 1/16 W 0603		RK73K1J102J or CR10-102J
R157	Metal Glaze 220 ohm ±5% 1/16 W 0603		RK73K1J221J or CR10-221J
R158	Metal Glaze 4.7 kohm ±5% 1/16 W 0603		RK73K1J472J or CR10-472J
R159	Metal Glaze 10 kohm ±5% 1/16 W 0603		RK73K1J103J or CR10-103J
R160	Metal Glaze 22 kohm ±5% 1/16 W 0603		RK73K1J223J or CR10-223J
R161	Metal Glaze 22 kohm ±5% 1/16 W 0603		RK73K1J223J or CR10-223J
R162	Metal Glaze 100 kohm ±5% 1/16 W 0603		RK73K1J104J or CR10-104J
R163	Metal Glaze 22 kohm ±5% 1/16 W 0603		RK73K1J223J or CR10-223J
R164	Metal Glaze 220 ohm ±5% 1/16 W 0603		RK73K1J221J or CR10-221J
R165	Metal Glaze 470 ohm ±5% 1/16 W 0603		RK73K1J471J or CR10-471J
R166	Metal Glaze 47 kohm ±5% 1/16 W 0603		RK73K1J473J or CR10-473J
R167	Metal Glaze 47 ohm ±5% 1/16 W 0603		RK73K1J470J or CR10-470J
R168	Metal Glaze 47 ohm ±5% 1/16 W 0603		RK73K1J470J or CR10-470J
R169	Metal Glaze 47 ohm ±5% 1/16 W 0603		RK73K1J470J or CR10-470J
R170	Metal Glaze 220 ohm ±5% 1/16 W 0603		RK73K1J221J or CR10-221J
R171	Metal Glaze 10 kohm ±5% 1/16 W 0603		RK73K1J103J or CR10-103J
R172	Metal Glaze 4.7 kohm ±5% 1/16 W 0603		RK73K1J472J or CR10-472J
R173	Metal Glaze 47 kohm ±5% 1/16 W 0603		RK73K1J473J or CR10-473J
R174	Metal Glaze 47 kohm ±5% 1/16 W 0603		RK73K1J473J or CR10-473J
R175	Metal Glaze 22 kohm ±5% 1/16 W 0603		RK73K1J223J or CR10-223J
R176	Metal Glaze 3.3 kohm ±5% 1/16 W 0603		RK73K1J332J or CR10-332J
R177	Metal Glaze 1.2 kohm ±5% 1/16 W 0603		RK73K1J122J or CR10-122J
R178	Metal Glaze 22 kohm ±5% 1/16 W 0603		RK73K1J223J or CR10-223J
R179	Metal Glaze 470 ohm ±5% 1/16 W 0603		RK73K1J471J or CR10-471J
R180	Metal Glaze 100 ohm ±5% 1/16 W 0603		RK73K1J101J or CR10-101J

Ref. No.	Description				RS Part No.	Mfr's Part No.
R181	Metal Glaze	10 kohm	±5%	1/16 W 0603		RK73K1J103J or CR10-103J
R182	Metal Glaze	470 ohm	±5%	1/16 W 0603		RK73K1J471J or CR10-471J
R183	Metal Glaze	470 ohm	±5%	1/16 W 0603		RK73K1J471J or CR10-471J
R184	Metal Glaze	470 ohm	±5%	1/16 W 0603		RK73K1J471J or CR10-471J
R185	Metal Glaze	470 ohm	±5%	1/16 W 0603		RK73K1J471J or CR10-471J
R186	Metal Glaze	3.3 kohm	±5%	1/16 W 0603		RK73K1J332J or CR10-332J
R187	Metal Glaze	10 kohm	±5%	1/16 W 0603		RK73K1J103J or CR10-103J
R188	Metal Glaze	15 kohm	±5%	1/16 W 0603		RK73K1J153J or CR10-153J
R189	Metal Glaze	100 ohm	±5%	1/16 W 0603		RK73K1J101J or CR10-101J
R190	Metal Glaze	470 ohm	±5%	1/16 W 0603		RK73K1J471J or CR10-471J
R191	Metal Glaze	100 ohm	±5%	1/16 W 0603		RK73K1J101J or CR10-101J
R192	Metal Glaze	150 kohm	±5%	1/16 W 0603		RK73K1J154J or CR10-154J
R193	Metal Glaze	470 ohm	±5%	1/16 W 0603		RK73K1J471J or CR10-471J
R194	Metal Glaze	680 ohm	±5%	1/16 W 0603		RK73K1J681J or CR10-681J
R195	Metal Glaze	10 kohm	±5%	1/16 W 0603		RK73K1J103J or CR10-103J
R196	Metal Glaze	1.5 kohm	±5%	1/16 W 0603		RK73K1J152J or CR10-152J
R197	Metal Glaze	6.8 kohm	±5%	1/16 W 0603		RK73K1J682J or CR10-682J
R198	Metal Glaze	47 ohm	±5%	1/16 W 0603		RK73K1J470J or CR10-470J
R199	Metal Glaze	47 ohm	±5%	1/16 W 0603		RK73K1J470J or CR10-470J
R200	Metal Glaze	10 kohm	±5%	1/16 W 0603		RK73K1J103J or CR10-103J
R201	Metal Glaze	4.7 kohm	±5%	1/16 W 0603		RK73K1J472J or CR10-472J
R202	Metal Glaze	470 kohm	±5%	1/16 W 0603		RK73K1J474J or CR10-474J
R203	Metal Glaze	220 kohm	±5%	1/16 W 0603		RK73K1J224J or CR10-224J
R204	Metal Glaze	1 kohm	±5%	1/16 W 0603		RK73K1J102J or CR10-102J
R205	Metal Glaze	100 ohm	±5%	1/16 W 0603		RK73K1J101J or CR10-101J
R206	Metal Glaze	4.7 kohm	±5%	1/16 W 0603		RK73K1J472J or CR10-472J

Ref. No.	Description	RS Part No.	Mfr's Part No.
Transformers			
T101 T102 T103	IF (1st) IF (2nd) IF (2nd)	Helical Filter	GR-D854 5SSI-354 5SSI-354
Trimmer Capacitors			
TC101 TC102	6 pF 30 pF		ECR-LA006A12 ECR-LA030E12
Crystal			
X101	12.8 MHz		TR-1 12.8 MHz
Miscellaneous			
CN101 CN102 CN103 TP101 TP102 TP103 GND	Connector, 6-Pin Male Connector, 4-Pin Male Connector, 5-Pin Female Pin, Test Pin, Test Pin, Test Pin, Test Shield, PLL (Top) Shield, PLL (Case) Shield, PLL (Bottom)		IL-Y-6P-S15T2-EF IL-Y-4P-S15T2-EF 174074-5 GE-87D-7290 GE-87D-7290 GE-87D-7290 GE-87D-7290 GE-91D-9221 or GE-94D-1089 GE-91D-9222 or GE-94D-1088 GE-91D-9223

SEMICONDUCTOR LEAD IDENTIFICATION

INTEGRATED CIRCUITS

IC1 GRE-9409

See "Microprocessor (IC1) Port Format" on Page 50.

IC2, IC3 XL93LC66RF
or NM93C66LM8

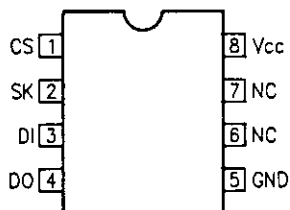

IC4 S80737AL-A1

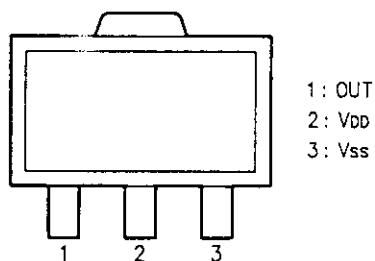

IC5 S80746AL-EA

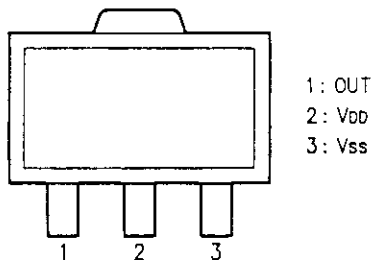

IC101 CXA1356N

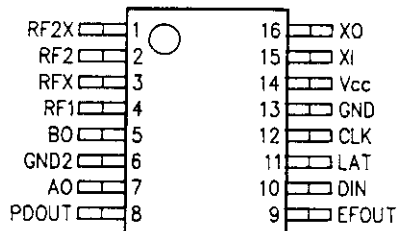

IC102 MB1512PFV-G

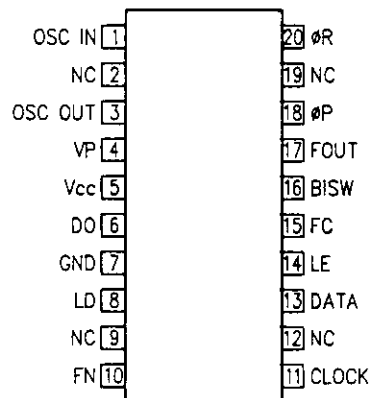

IC301 TA31136FN

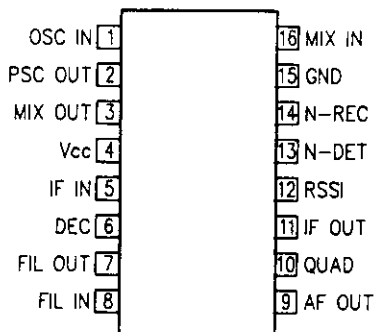

IC302 CX20111

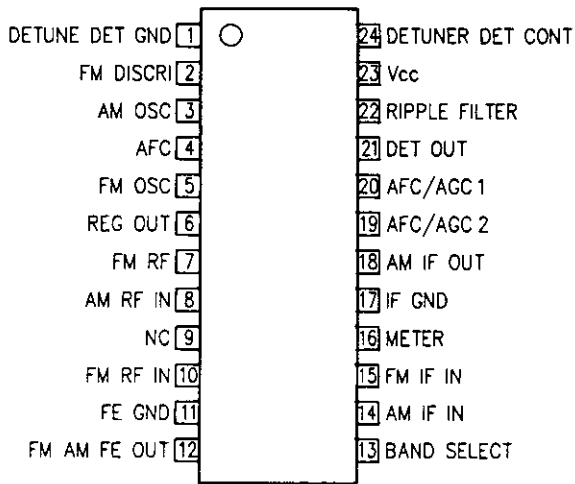

IC303 TC74HC4066AFS

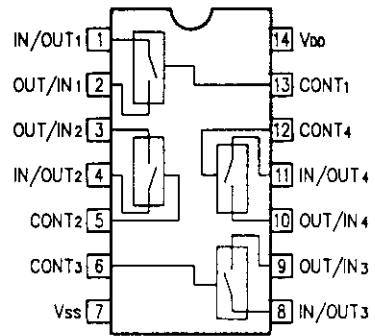

IC304 BA10358F
or NJM2904G

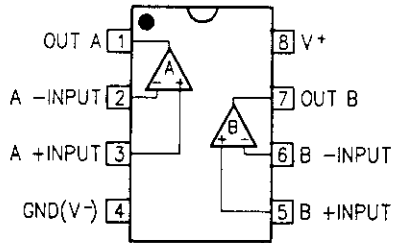

IC305 TC7W139F

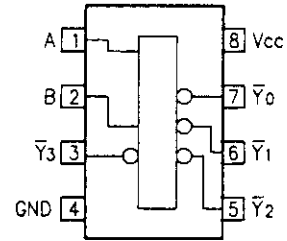

IC306 LM386N-1
or NJM386BD

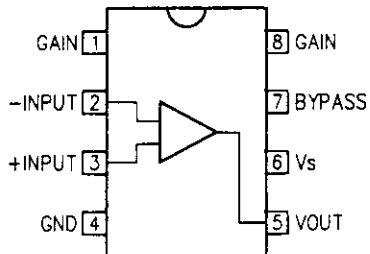

IC307 S-81250HG-RD

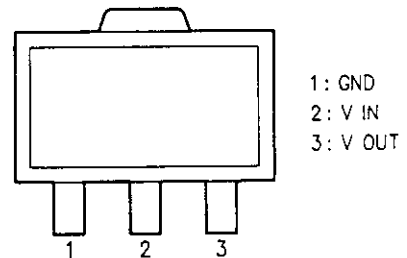

IC308 TK11806M

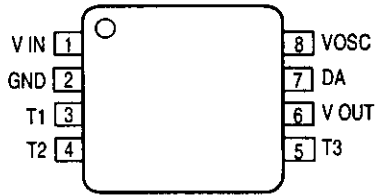

IC309 TK10682

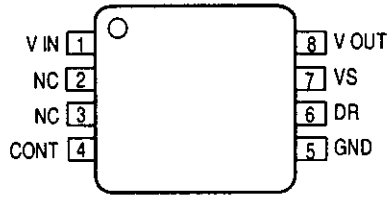

TRANSISTORS

(A) 2SC2712(GR) Marked LG

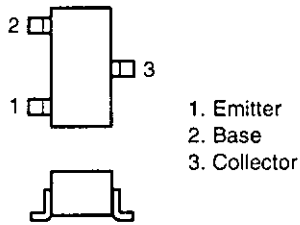

(B) 2SC4116(Y) Marked LY
2SC4116(GR) Marked LG
2SC4215(O) Marked QO
2SC4226(R25) Marked R25

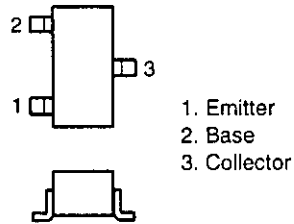

(C) DTA143ZUA Marked 113
DTC114YUA Marked 64
DTC363EK Marked H27

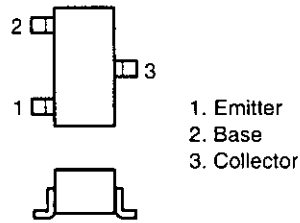

(D) UMA9N Marked A9

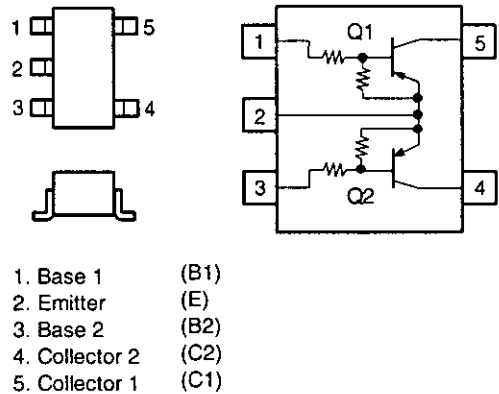

(E) 2SK209(GR) Marked XG

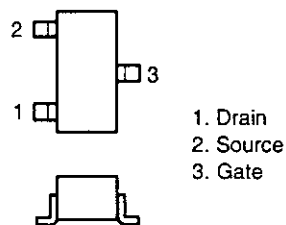

DIODES

(A) 1SS272 Marked A1
or 1SS306 Marked A3

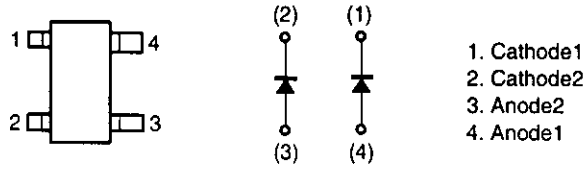

(B) DA227 Marked N20

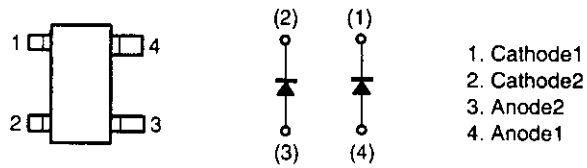

(C) HSM2693A Marked B4

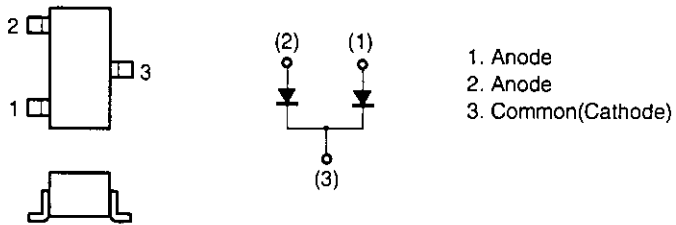

(D) HSU277 Marked 3

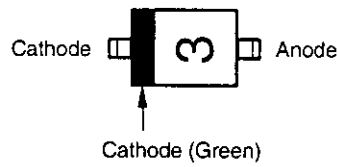

(E) HVU12 Marked A



(F) HVU306A Marked 3

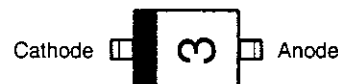

(G) HVU308 Marked 8



(H) LT1E51A

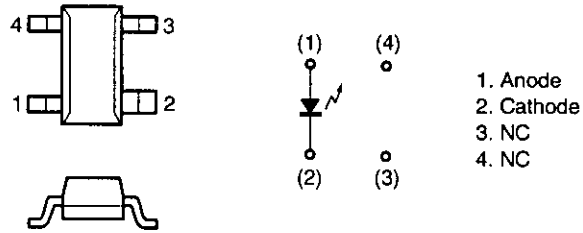

(I) MA121 Marked M2D

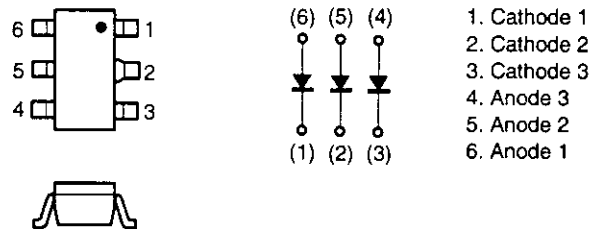

(J) ND433G

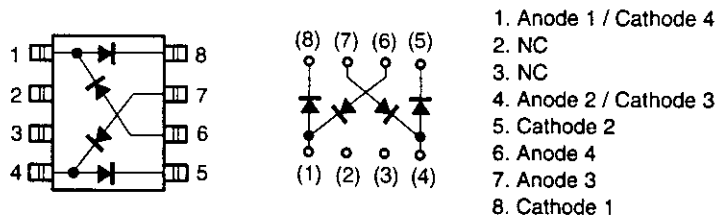

(K) RL1N4002

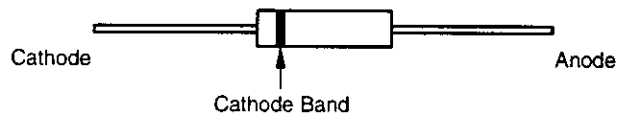

MICROPROCESSOR (IC1) PORT FORMAT

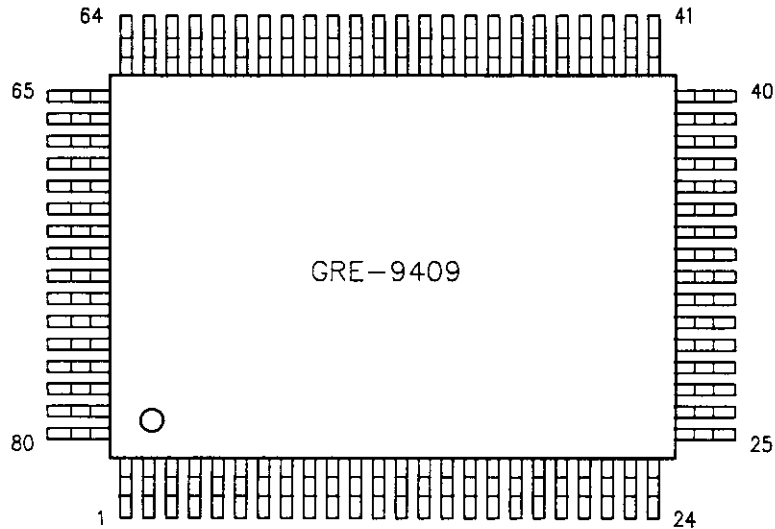

Pin No.	Function	Pin No.	Function
1	LCD segment driver output	41	GND
2	LCD segment driver output	42	Key input
3	LCD segment driver output	43	Key input
4	LCD segment driver output	44	Key input
5	LCD segment driver output	45	Key input
6	LCD segment driver output	46	Key output
7	LCD segment driver output	47	Key output
8	LCD segment driver output	48	AM/FM/WFM output
9	LCD segment driver output	49	Peep output
10	LCD segment driver output	50	Key output
11	LCD segment driver output	51	Key output
12	LCD segment driver output	52	Key output
13	LCD segment driver output	53	Key output
14	NC	54	VDD
15	NC	55	+B
16	NC	56	NC
17	Memory serial data output	57	NC
18	Memory chip select	58	Resonator connection terminal
19	Memory chip select	59	Resonator connection terminal
20	Memory serial data clock	60	Backlight output
21	LCD common driver output	61	Power control
22	LCD common driver output	62	Mute output
23	LCD common driver output	63	Zeromatic control
24	LCD common driver output	64	Zeromatic input
25	LCD bias control	65	Squelch input
26	LCD drive power supply	66	Low battery input
27	LCD drive power supply	67	Memory data input
28	LCD drive power supply	68	HOLD input
29	WFM output	69	LCD segment driver output
30	Band 5 output	70	LCD segment driver output
31	Band 4 output	71	LCD segment driver output
32	Band 3 output	72	LCD segment driver output
33	Vss	73	LCD segment driver output
34	Band 2 output	74	LCD segment driver output
35	Band 1 output	75	LCD segment driver output
36	PLL latch 1 output	76	LCD segment driver output
37	PLL latch 2 output	77	LCD segment driver output
38	Key input	78	LCD segment driver output
39	PLL serial clock output	79	LCD segment driver output
40	PLL serial data output	80	LCD segment driver output

SCHEMATIC DIAGRAM

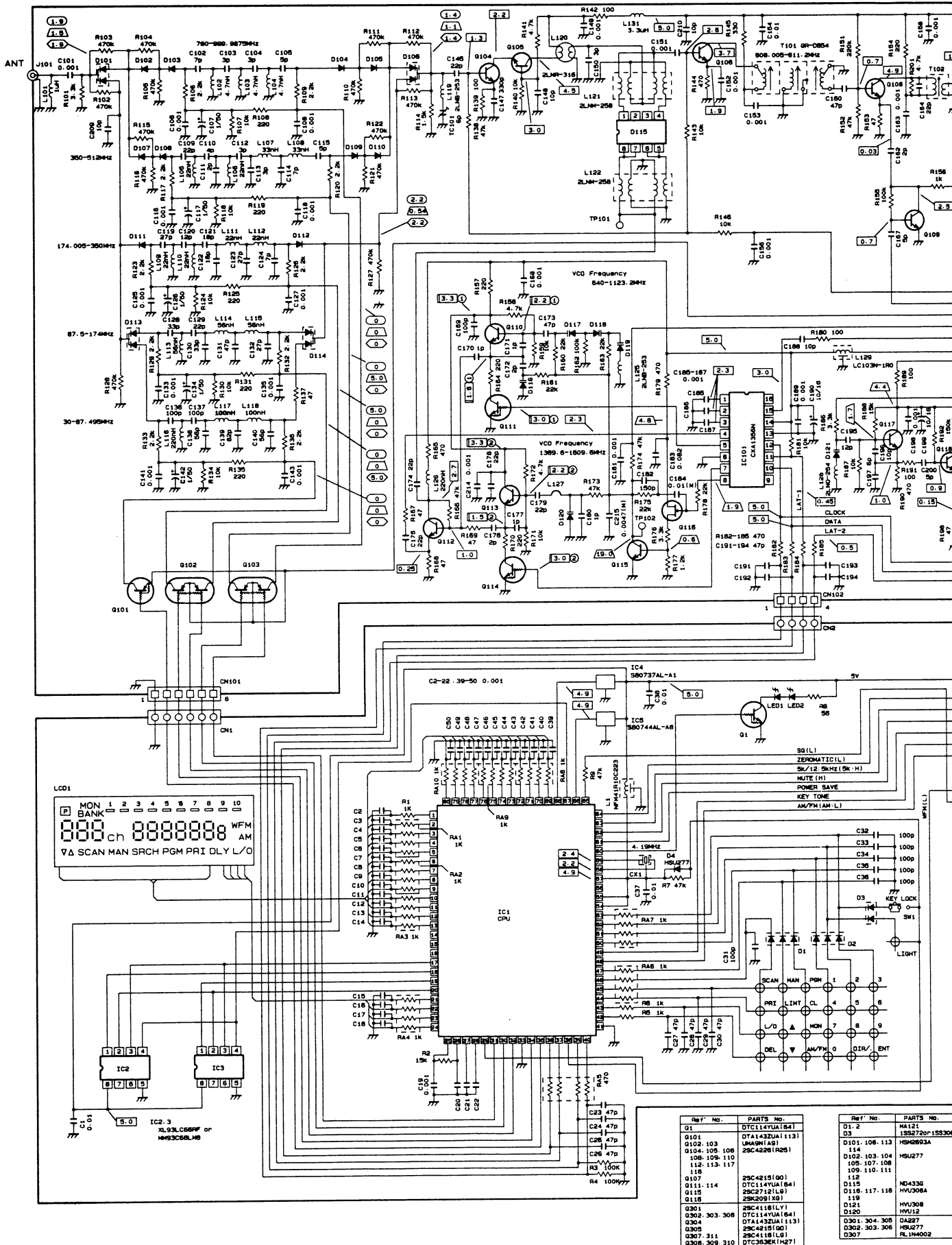

Ref# No.	PARTS No.	Ref# No.	PARTS No.
Q1	DTC114VUA (64)	D1, 2	MA121
Q101	DTA1432UA (113)	D3	HS220P1SS300
Q102, 103	UM49M1A9	D101, 106, 113	HS4263A
Q104, 105, 106	Z8C4226 (R25)	114	
106, 109, 110		D102, 103, 104	HSU277
112, 113, 117		105, 107, 108	
		109, 110, 111	
Q107	25C4215 (G0)	112	ND4336
Q111, 114	DTC134VUA (64)	D115	HSU306A
Q115	25C2712 (L8)	D116, 117, 118	HSU306A
Q118	25C209 (X8)	119	HSU308
Q301	25C4118 (L1)	D120	HSU312
Q302, 303, 306	DTC114VUA (64)		
Q304	DTA1432UA (113)	D301, 304, 306	DA227
Q305	25C4215 (G0)	Q302, 303, 306	HSU277
Q307, 311	25C4118 (L1)	D307	RL1M4002
Q308, 309, 310	DTC363EK (H27)		

RADIO SHACK
A Division of Tandy Corporation
Fort Worth, Texas 76102