

IMPORTANTE IMPORTANT

ESEMPIO 1 EXEMPLE 1

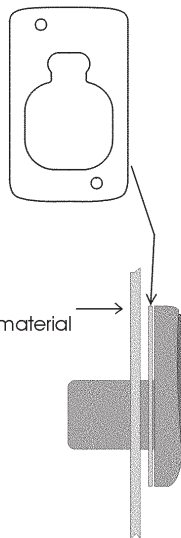

Porta del D.A. In plastica
Door of the vending machine in plastic material

ESEMPIO 2 EXEMPLE 2

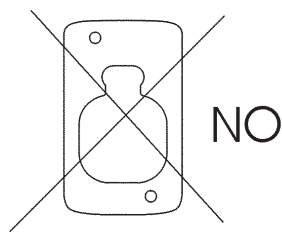

Porta del D.A. In metallo
Door of the vending machine in metal material

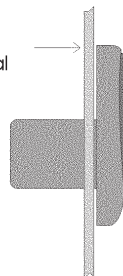

ESEMPIO 3 EXEMPLE 3

Porta del D.A. In plastica con lamiera all'interno
Door of the vending machine in plastic material with an additional internal metal sheet

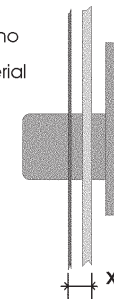

$X < 5 \text{ mm.}$

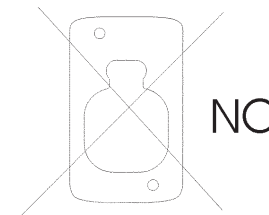

$X > 5 \text{ mm.}$

Bisogna togliere la lamiera interna o fare un foro di diametro pari ad almeno 70mm come da disegno

The internal metal sheet must be removed or, like in the picture, make an hole of 70 mm. minimum diameter.

1)

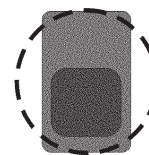

Diametro
Diameter = $> 70\text{mm}$

2)

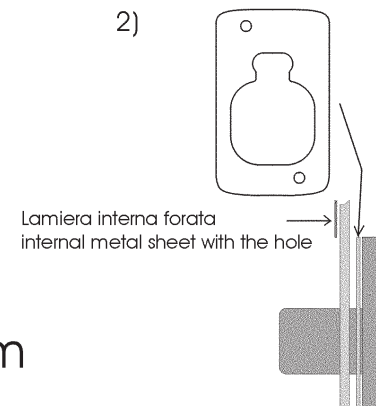

Porta del D.A. In plastica
Door of the vending machine in plastic material